

Interreg



ITALIA-SLOVENIJA



FORTIS

Progetto standard co-finanziato dal Fondo europeo di sviluppo regionale
Standardni projekt sofinancira Evropski sklad za regionalni razvoj

D.3.1.2.1:

“Assessment of territorial needs, strategic priorities and proposals for measures for the development of public passenger transport by involving and informing selected stakeholders in the Italy-Slovenia cross-border area within the FORTIS project”

Final report

This project is supported by the Interreg V-A Italy-Slovenia Cooperation Programme funded by the European Regional Development Fund. This project aims at improving public transport connections in the cross-border area between Italy and Slovenia, through innovative solutions and at facilitating mutual knowledge on vehicle registration.

The content of this publication does not necessarily reflect the official positions of the European Union.

Author: For the Regional development agency of Ljubljana urban region, prepared by the Transport institute Ljubljana, d.o.o. Kolodvorska 11, 1000 Ljubljana

June 2020

TABLE OF CONTENTS

1	INTRODUCTION	1
1.1	AIM.....	1
1.2	OBJECTIVE.....	1
1.3	SCOPE	2
1.3.1	Area of observation	2
1.3.2	Project activities	4
2	GENERAL PRESENTATION OF ITALY - SLOVENIA CROSS-BORDER REGION.....	6
2.1	TERRITORIAL DESCRIPTION.....	6
2.1.1	Geography	6
2.1.2	Settlements and territorial organisation.....	8
2.2	TRANSPORT DEMAND - MAIN TRAFFIC FLOWS	9
2.3	TRANSPORT SUPPLY - INFRASTRUCTURE NETWORKS	14
2.3.1	Road network	14
2.3.2	Public passenger network	17
2.3.2.1	Railway network	18
2.3.3	Modal split.....	21
3	PUBLIC PASSENGER TRANSPORT CONNECTIVITY	23
3.1	ORGANISATION OF TRANSPORT SECTOR.....	23
3.1.1	Italy.....	23
3.1.1.1	Infomobility	25
3.1.2	Slovenia.....	26
3.1.2.1	Infomobility and ticketing.....	27
3.2	REGIONAL PUBLIC TRANSPORT CONNECTIVITY	28
3.3	CROSS-BORDER PUBLIC TRANSPORT CONNECTIVITY.....	35
3.3.1	Order crossing lines	36
3.3.1.1	Railway transport.....	37
3.3.1.2	Bus transport.....	38
3.3.1.3	Maritime transport	50
3.3.1.4	Intermodal transport.....	51
3.3.1.5	Hinterland connections	56

3.4	INTEGRATION OF PUBLIC PASSENGER TRANSPORT	57
3.4.1	Management of integration	57
3.4.2	Integrated lines	58
3.4.2.1	Local integration	59
3.4.2.2	Cross-border integration.....	59
3.4.3	Issues of cross-border integration.....	60
4	STRATEGIC PRIORITIES FOR IMPROVEMENT OF PUBLIC TRANSPORT ACCESSIBILITY.....	62
4.1	REVIEW OF INSTITUTIONAL PRIORITIES	62
4.1.1	EU legislation on operation of cross-border passenger transport	62
4.1.2	Cross-border cooperation for sustainable mobility	63
4.1.2.1	EU legislative framework	63
4.1.2.2	Bilateral agreements concluded between Italian Republic and Republic of Slovenia	64
4.1.2.3	Cross-border passenger transport strategies and projects	65
4.2	REVIEW OF PRIORITIES AND SUGGESTIONS BY THE RELEVANT STAKEHOLDERS	71
4.2.1	Identification of relevant stakeholders	71
4.2.2	Interviewees	72
4.2.3	Feedback analysis	72
4.2.3.1	Planning, registration and operation of cross-border lines	72
4.2.3.2	Determination of cross-border (international) ticket price	73
4.2.3.3	Monitoring of the occupancy of the cross-border (international) line	74
4.2.3.4	Containment of Covid-19 epidemic impact	74
4.2.3.5	Measures of CB public transport improvement by stakeholders	75
4.3	PROPOSALS FOR IMPROVEMENT OF CROSS-BORDER CONNECTIVITY.....	76
4.3.1	Challenges	76
4.3.2	Proposed measures by the study	79
5	SUMMARY	83
6	APPENDIX 1: CHARACTERISATION OF CB AND HINTERLAND.....	87
7	APPENDIX 2: TRANSPORT OPERATORS IN THE CROSS-BORDER AREA.....	88
8	APPENDIX 3: LIST OF IDENTIFIED RELEVANT STAKEHOLDERS FOR PROVISION AND IMPLEMENTATION OF CROSS-BORDER PUBLIC PASSENGER TRANSPORT SERVICES IN SLOVEIA AND ITALY	90
9	REFERENCES.....	93

1 INTRODUCTION

1.1 AIM

The aim of the study is a review of public passenger transport and intermodality at Italy - Slovenia cross-border (ITA-SLO CB) area and in suggestion of measures for improvement of conditions of use of public passenger transport for transport integration of population in the area. The study is provided in the framework of the FORTIS EU project.

1.2 OBJECTIVE

The objective is to estimate needs and strategic priorities to prepare a set of proposals of measures to improve an ITA-SLO cross-border public transport connectivity. This has been achieved by conduction of analysis of the area and points of transport flows attraction, followed by investigation of current regional and cross-border public transport connectivity in the observed ITA-SLO cross-border area by investigating road, railway and sea waterway public transport and intermodality situation. In pursue of enhancement of the current state the strategic priorities for improvement of connectivity have been drafted. The study incorporates actual experience and management of issues as well as proposals of improvement cross-border connectivity, polled from the public transport stakeholders in the area.

1.3 SCOPE

1.3.1 Area of observation

Figure 1: Area of observation - regional and hinterland points and TEN-T network

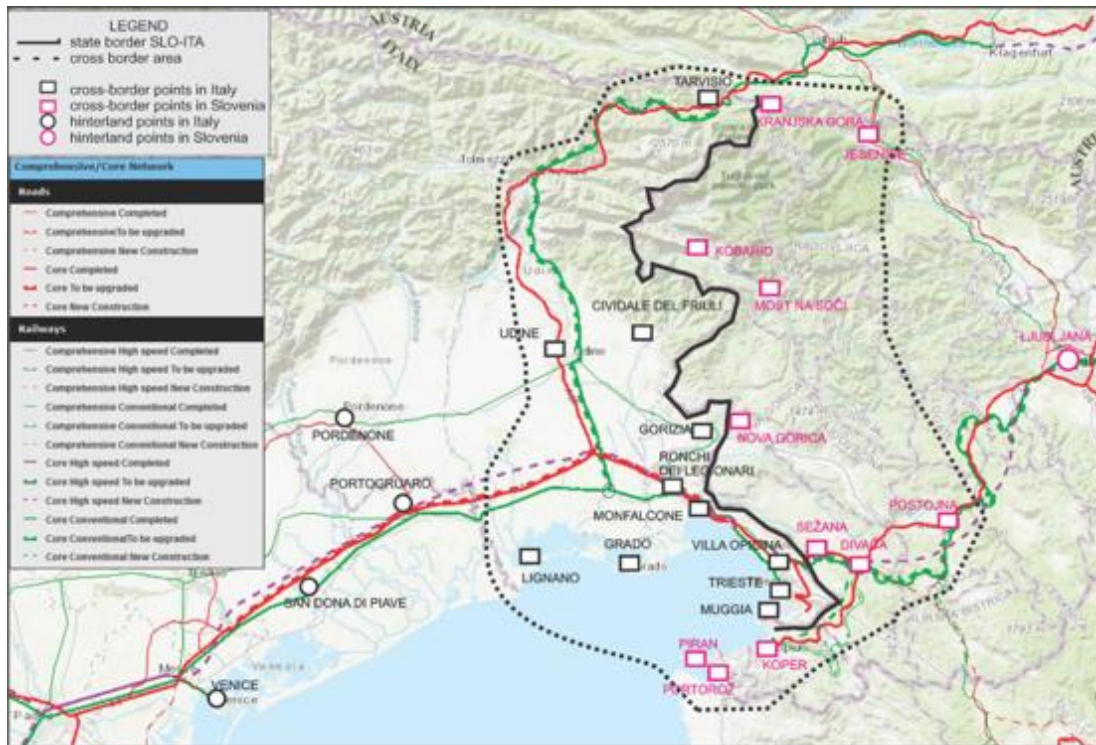

Source: <https://ec.europa.eu/transport/infrastructure/tentec/tentec-portal/map/maps.html> and Prometni institut, d.o.o.

The area of observation was defined by the FORTIS project partnership and is referenced and pursued accordingly through the whole study.

The area of observation is a cross-border area of Italy and Slovenia (ITA-SLO CB area) and transport links to the hinterland regional centres. It encompasses regional centres in Friuli Venezia Giulia (FVG) region and links to the regional centres in Veneto region on Italian side, as well as to the western region of Slovenia and links to Ljubljana on the Slovenian side. Transport links of observation belong to TEN-T core network (Mediterranean and Baltic-Adriatic corridor) and the connecting roads and railway tracks to the network nodes.

The area of observation with the layout of the ITA-SLO CB area is depicted in Figure 2. ITA-SLO CB area is demarked by the dotted line along the common border of Italy and Slovenia, showing

cross-border regional centres (also including points of interest - Pol - and transport hubs¹) as well as in hinterland gravitational centres (hinterland points).

Figure 2: Area of observation, ITA-SLO CB area

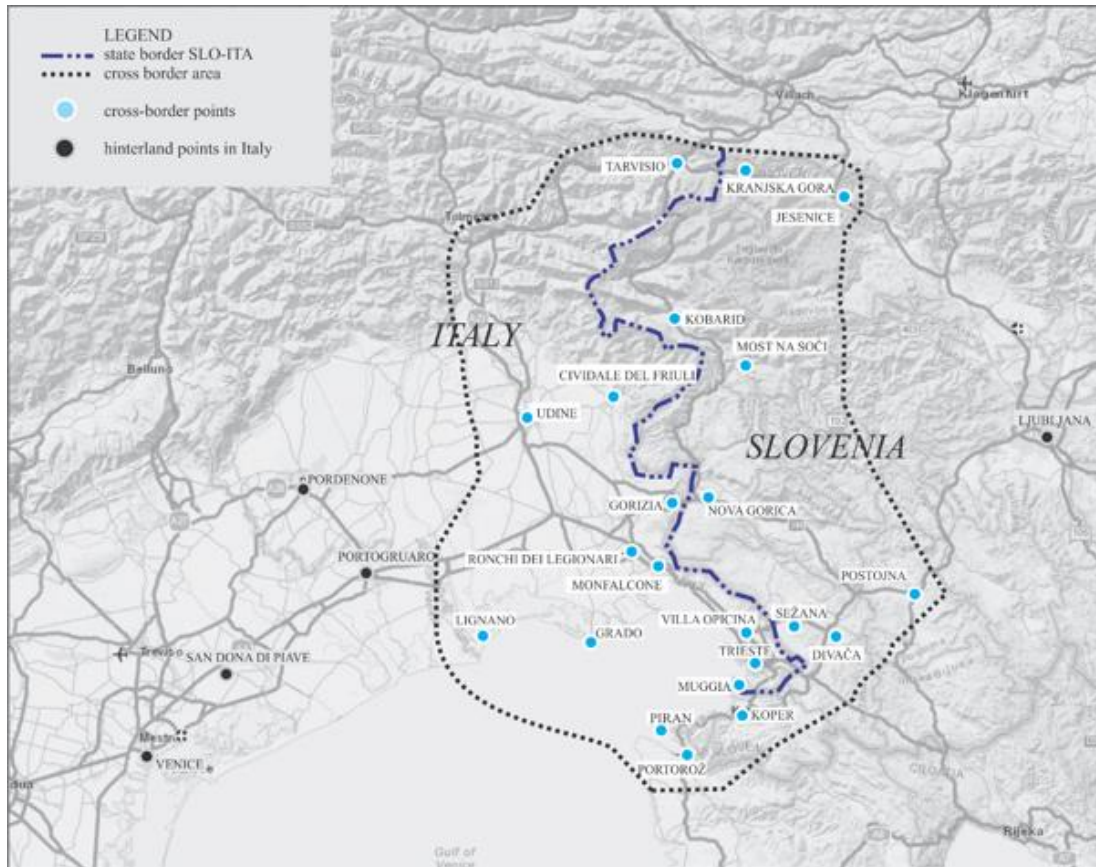

Source: <https://ec.europa.eu/transport/infrastructure/tentec/tentec-portal/map/maps.html> and Prometni institut, d.o.o.

The observed **CB area** consists of majority of FVG region territory and the Slovenian municipalities along the border, depicted by the main points:

- Italy:
 - o regional centres: Tarvisio, Udine, Gorizia, Cividale del Friuli, Trieste, Monfalcone
 - o hub: Villa Opicina
 - o Pol: Ronchi dei Legionari (airport), Muggia, Grado, Lignano
- Slovenia
 - o regional centres: Koper, Sežana, Postojna, Nova Gorica, Kobarid, Most na Soči, Kranjska Gora, Postojna (hub), Jesenice (hub)
 - o hub: Divača

¹ Transport hub is a point which is important as a transport network transfer point (e.g. San Donà di Piave) or intermodal point (e.g. Jesenice, Muggia).

- Pol: Piran, Portorož

The centres in CB area are connected to the gravitational **hinterland** centres, hubs or Pol, both in Italy and Slovenia:

- Italy:
 - regional centre: Venice, Pordenone²,
 - hub: Portogruaro, San Donà di Piave
- Slovenia: Ljubljana.

Some points of observation can feature at the same time a regional centre, a hub or a Pol.

1.3.2 Project activities

The study is focussed on analysis of cross-border public transport connectivity rather to personal transport and shuttle. The shuttles can to some extent impact behaviour of passengers on these routes although they are dedicated to occasional travellers rather than daily commuters, which also entails specific ticketing and reservation system they use. Sea waterway connections are mainly in operation only for occasional transport (e.g. Trieste (IT), Piran (SI) M. Lošinj (CR) - one daily departure), which is more frequent only in the summer season.

Input data reflect the situation in the cross-border area separately for each border side and cross-border lines, respectively. For obtaining the overall image also the possible links and integration of the existing regional lines connecting cross-border and hinterland centres was considered.

For preparation of the study the following main activities were performed:

- collection of geography, economy and educational and transport networks data in SLO-ITA cross-border area, obtained from the finished national, cooperation and relevant EU projects: CONNECT2CE, CROSSMOBY, INTERCONNECT, EASEAWAY, ADRIA A, etc.;
- collection of data on regional and border crossing lines at:
 - Ministry of Infrastructure of Slovenia (bus lines),
 - Slovenian Railways (train paths),
 - Luška kapitanija Koper (seawater lines);
 - Friuli Venezia Giulia (regional and seawater lines) and
 - transport web portals;
- polling of experience and proposals from the transport stakeholders in CB area (questionnaires);
- integration of regional data (Italian, Slovenian) to get a common CB area image;
- synthesizing of data into study analyses.

The study is composed of 3 main parts:

² Pordenone, although being part of FVG, is considered hinterland due to its distance from the border.

- general presentation of Italy-Slovenia cross-border region (territorial description, transport demand, transport supply),
- public passenger transport connectivity (organisation of transport sector, regional connectivity, cross-border connectivity, transport integration),
- strategic priorities for improvement of public transport connectivity (review of institutional priorities, suggestions by the relevant stakeholders, proposals for improvement of cross-border connectivity).

2 GENERAL PRESENTATION OF ITALY - SLOVENIA CROSS-BORDER REGION

The Slovenia - Italy cross-border region as defined in the paragraph **Error! Reference source not found.** in geographical terms and also from a historical point of view forms a uniform region that has been split by the national border between the two countries, namely Italy at the west and Slovenia at the east of the border. Commuting and cross-border cooperation are part of the daily life of people living close to the borders, thus bringing about close connections between the neighbouring regions of Friuli Venezia Giulia and Slovenia. The Gorizia on Italian side and Nova Gorica on the Slovenian should be pointed out as remarkable border township where two cities, each on one side of the border share the same city square³ and also some public services (e.g. Nova Gorica maternity hospital).

In this view, wherever possible, the CB region is presented as one territory, although having different territorial organisation and authorities in each country as well as a heritage of uncoordinated development priorities in previous years.

2.1 TERRITORIAL DESCRIPTION

2.1.1 Geography

Italy - Slovenia cross-border area is stretching along over 232 border kilometres and is situated in Central Europe touching the Alps in the north and bordering the Mediterranean Sea, spreading to Italian region Friuli Venezia Giulia at the West and Slovenia at the East.

Figure 3: Relief of the ITA-SLO CB area

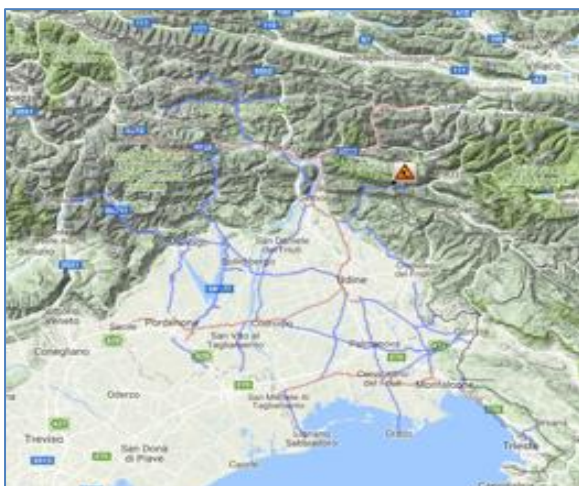

³ Piazza Europa (IT) = Trg Evrope (SI)

The CB area is extremely diversified in terms of morphology as it crosses mountains, plains and coastal zones. It is also characterised by the presence of diverse natural landscapes. Northern and Eastern part of the CB area is mainly featured by mountainous terrain, whereas Western part extends to the plains. Italian side is predominantly densely populated, while the Slovenian is mainly rural with smaller towns and only a few larger settlements. Although diversified along the border line, the same morphology, scenery and also cultural characteristics transversely extend on both side of the border, in turn forming a single area.

The rich natural and geological diversity in Slovenia also results in transport infrastructure and its operation. In the South-West, Slovenia has a 50 km long share of the Adriatic Sea coast where also the most important Slovenian port, Port of Koper, is situated. Northern part of Slovenia is characterised by the Alpine region, with the Julian Alps in the North-West as the highest mountain range in Slovenia, also influencing Slovenian position within the European transport corridors.

Friuli Venezia Giulia Region (FVG) is placed in North-Eastern part of Italy and it borders with two foreign countries, Slovenia (to the East) and Austria (to the North), while in the West it shares a border with Italian Veneto Region, see Figure 4.

Figure 4: Borders and provinces of Friuli Venezia Giulia region



Veneto Region further borders with another three Italian regions to the West and South and with Austria to the North. Especially the area close to Austria features high mountain range, connected to the neighbouring country (A) only by hiking and biking trails. In terms of morphology the region can be classified in main areas, the alpine/pre-alpine area, the hills, and the plain with the coastal area, taking 57% of surface share. The plain area includes the eastern part of the Lake

Garda (the largest in Italy) at the West and Venice Lagoon with 100 km of beaches at the eastern part.

2.1.2 Settlements and territorial organisation

FVG Region is one of the smallest regions of North-East Italy with about 7.856 km² and 1,2 million inhabitants, distributed in 216 municipalities. Although Trieste is the seat of the Regional Government and the main administrative centre of the Region, the majority of population (almost 70%) is distributed among Udine and Pordenone, taking over 70% of municipalities (155 out of 216) in the region, each with a population of less than 5.000 inhabitants, except the main 6 municipalities, counting more than 20.000 inhabitants. FVG region is an autonomous region, which gives it specific authorities in regional and cross-border public transport planning.

The whole Slovenia covers 20,271 square kilometres and has a population of 2.095.861 inhabitants (2020 census). With 103 inhabitants per square kilometre, Slovenia ranks low among the European countries in population density. This fact can be attributed to the vast share of mountainous and hilly regions.

Slovenia, as a country, has 9 municipalities with population larger than 30.000 inhabitants, Ljubljana, Maribor, Celje, Kranj, Koper, Velenje, Novo Mesto, Domžale and Nova Gorica. The population of the biggest agglomerations in the country, Maribor and Ljubljana amount to almost 100.000 and 300.000, respectively.

NUTS statistical organisation differs at Italian and Slovenian side of the CB area because of substantial difference in the size of the two countries.

Figure 5: Map of NUTS3 territorial classification in the CB and hinterland area



Source: <https://ec.europa.eu/transport/infrastructure/tentec/tentec-portal/map/maps.html> and Prometni institut, d. o. o.

At the NUTS2 level Slovenia is divided in two cohesion regions:

- SI03 is Western Slovenia bordering Croatia on the South, Italy on the West and Austria on its Northern borders
- SI04 is Eastern Slovenia bordering Croatia on the South and East, Hungary on North-East and Austria on North.

The NUTS2 regions of Slovenia are divided to 12 NUTS3 regions. The main purpose of NUTS3 statistical regions (further on referred as regions) is to provide more detailed statistical parameters, but they are not assigned any legal authority as autonomous regions. Those regions do not have their own regional legislation or a regional budget and are further divided to local administrative units. The whole Slovenia is divided into 212 municipalities.

FVG Region is identified by NUTS2 code ITH4, whereas its four provinces (Pordenone, Udine, Gorizia and Trieste) are respectively identified by NUTS3 codes ITH41, ITH42, ITH43 and ITH44.

The main settlements in the CB area are located in the southern and south-western plains, which mainly belong to Italy. The main centres in FVG Region are Gorizia, Pordenone, Udine, Palmanova, Monfalcone, Cividale and Tarvisio. The main centres in the Slovenian part of the CB area are Nova Gorica, Postojna and Koper.

As depicted in the **Error! Reference source not found.**, SLO-ITA CB region takes up 5 Slovenian NUTS3 regions (Gorenjska, Goriška, Obalno-kraška, Primorsko-Notranjska) and 4 NUTS3 provinces at the Italian side (Trieste, Gorizia, Udine, Pordenone) and 2 hinterland regions, Osrednjeslovenska in Slovenia and Venice province in Italy.

2.2 TRANSPORT DEMAND - MAIN TRAFFIC FLOWS

In terms of gravitation the SLO-ITA CB region is also presented by the area limited by 50 km diameter circles around border crossings as depicted in, also showing regional centres and other points of interest. The figure clearly shows myriad of border crossings, work and educational centres aligned all along the state border.

A cross-border dimension of the ITA-SLO CB region has a strong impact on movement of the population. Commuting and other cross-border connections are in fact part of the daily life of people living close to the borders. This contributed to the establishment of concrete and stable connections between Friuli Venezia Giulia and Slovenia, with particular reference to Gorizia/Nova Gorica and Trieste/Sežana cross-border sections. The part to the North of the CB region is dotted with many mountain pass border crossings due to high mountains and narrow valleys.

Despite the historical and geographic connections in the ITA-SLO CB area only 12% of the population in the area travel across the border for work or business purposes, more specifically 14% from Slovenia to Italy and 10% from Italy to Slovenia. This level of integration of the labour market has been assessed as lower than the EU average, which leaves scope for improvement. It

can therefore be considered that there is an untapped potential for developing cross-border labour mobility on the ITA-SLO border, which can also benefit from an existing EURES office located in Slovenia. CB mobility has many benefits (reduce unemployment, increase activity in enterprises, keep people in the region, etc.) but touches many dimensions from the recognition of skills/ qualifications/ diplomas, social security, pensions, taxations, transport, schools/ kindergarten, etc. that need to be tackled with a strategic approach using the appropriate level of cooperation and tools⁴.

Figure 6: Cross-border dimension of the regional centres along the Italy - Slovenia border

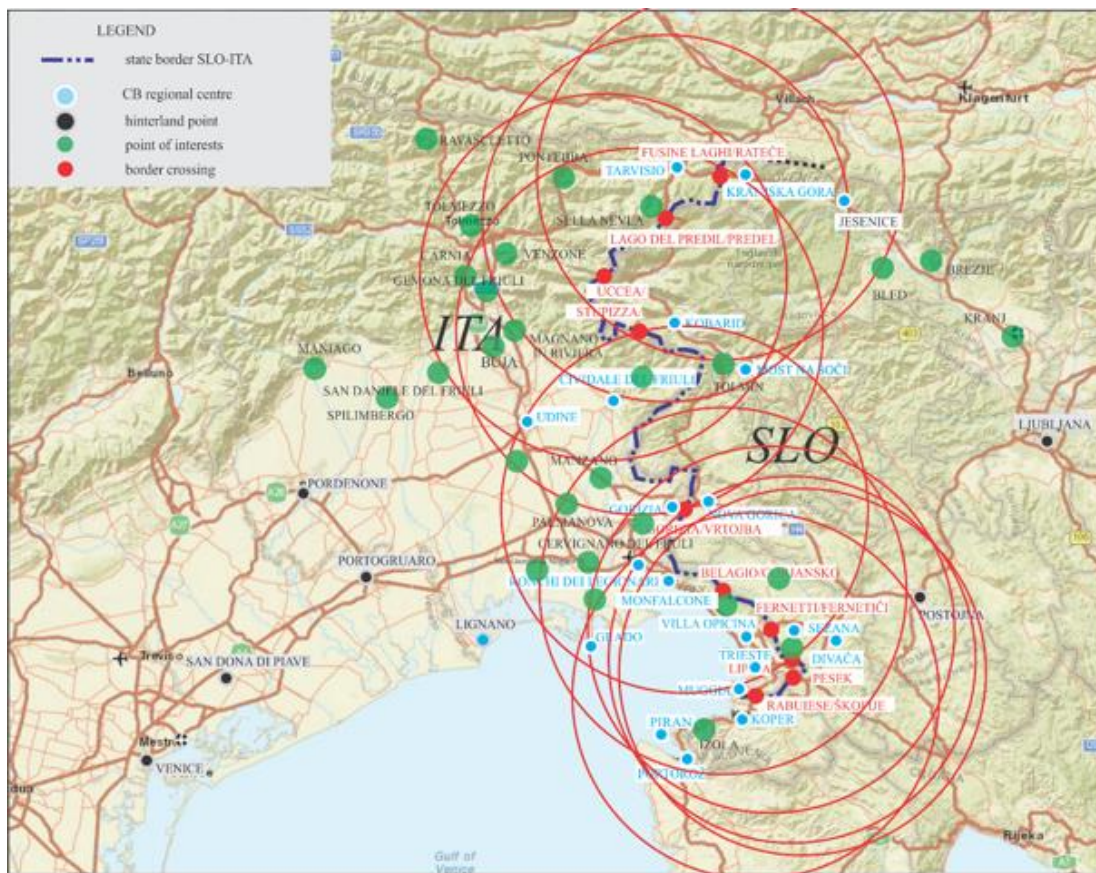

Source: <https://ec.europa.eu/transport/infrastructure/tentec/tentec-portal/map/maps.html> and Prometni institut, d. o. o.

The main drive for daily commuting are work and educational opportunities across the border and at the regional scale. The main production activities and education centres in the CB area are located in main regional centres which are also the biggest settlements in the area. Consequently, they are attracting the majority of commuter flows of the region, especially in consideration of widespread presence of villages and small municipalities characterized by a very limited demand of mobility.

⁴ EU Commission, DG REGIO, Border Orientation Paper: ITALY - SLOVENIA, Ref. Ares(2019)3244965 - 17/05/2019

In FVG Region the centrally positioned municipality of Udine is the most important node for regional mobility, attracting 7,6% of the total mobility needs, followed by Trieste (6,9%), Pordenone (4,2%) and Gorizia (2,9%). On the Slovenian side, on the other hand, Postojna, Nova Gorica and Koper make the main traffic flow attractors.

The CB area boasts with many educational centres, both on secondary as well as university levels, which generates weekly as well as daily transport demand for the students. The main universities in CB are located in Trieste, Udine, Gorizia, Koper and Nova Gorica. **Error! Not a valid bookmark self-reference.** shows the points of mobility attraction for educational purpose.

Figure 7: Settlements, secondary schools and universities in the CB area

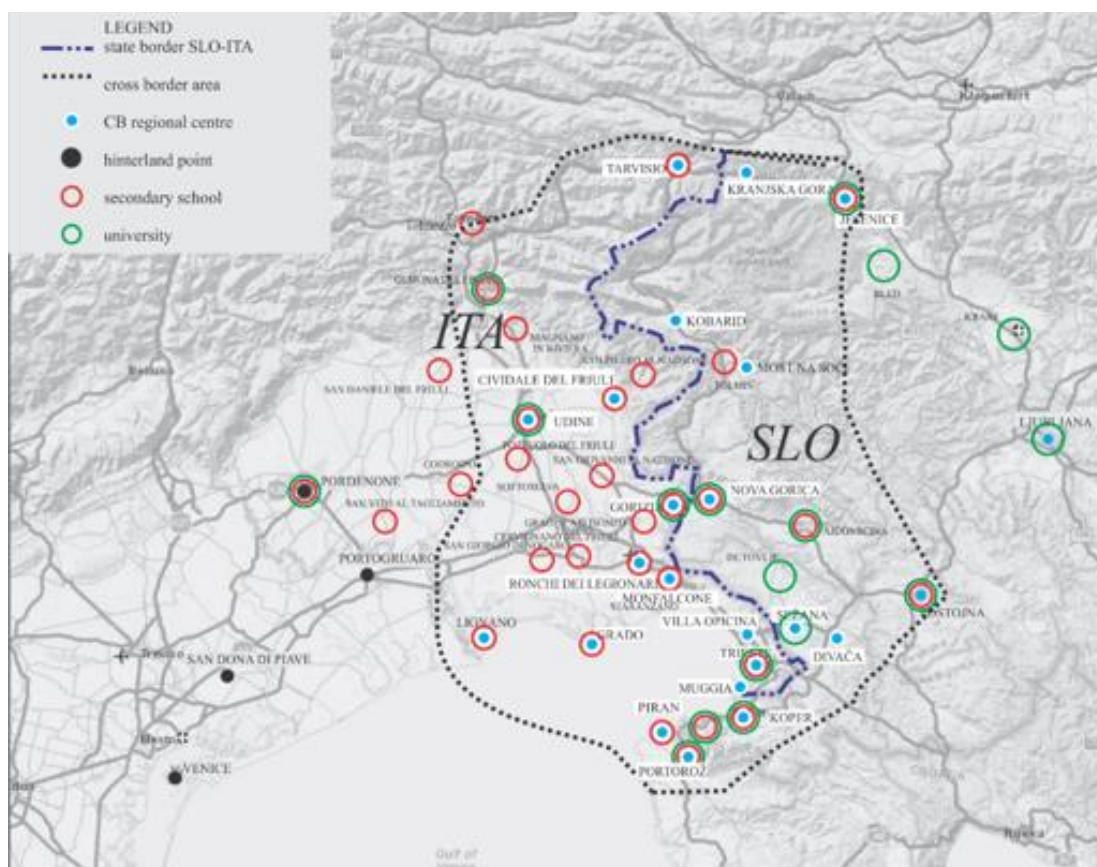

Source: <https://ec.europa.eu/transport/infrastructure/tentec/tentec-portal/map/maps.html> and Prometni institut, d. o. o.

Industry is mainly organised in industrial districts, having important impact on daily commuting. In FVG Region some important industrial centres need to be pointed out such as Monfalcone shipbuilding, industrial activities in Trieste port area, knife production in Maniago (Pordenone), digital technologies in Tavagnacco (Udine), the industrial districts of chairs, furniture and wood between Udine and Pordenone, where also the one of engineering industry is located, as well as the alimentary ones such as San Daniele del Friuli ham and Trieste coffee.

With 49 % of total population living in the urbanised areas, the main commuting gravitational points of Slovenia have centralised in main urbanised areas. The capital of Ljubljana itself, having more than 280.000 inhabitants, accepts around 130.000 daily commuters. Almost two-thirds of people are employed in services, and over one-third in industry and construction (2016 data). The main industrial centre at the Slovenian side of CB area is Postojna (sanitary ware, toys manufacturing, wood industry); in Nova Gorica, Sežana and Koper a bigger role is played by service supply, especially in transport and logistics.

Tourism is a substantial attractor of transport flows to the CB region. It is a relevant and strongly increasing economic sector on both sides of the border, but with differences with regard to targets (seaside, mountain, and cities), types (leisure, green tourism, cultural trip) and dimensions.

In FVGR many municipalities attract remarkable touristic flows, with particular reference to seasonal tourism at the seaside during summer period (e.g. Lignano Sabbiadoro and Grado), and in the mountains during summer as well as winter period (e.g. Tarvisio, Sella Nevea, Sappada, Ravascletto, Piancavallo). The attractive locations in the region are also archaeological and historical sites with traces of ancient Roman civilisation (e.g. Aquileia, Cividale del Friuli, Palmanova) as well as natural or geological places (e.g. Sgonico, Villanova). The region of Friuli-Venezia-Giulia (FVG) itself attracts about 3 million visitors per year.

Figure 9: Main tourist points of attraction at ITA-SLO CB area and hinterland

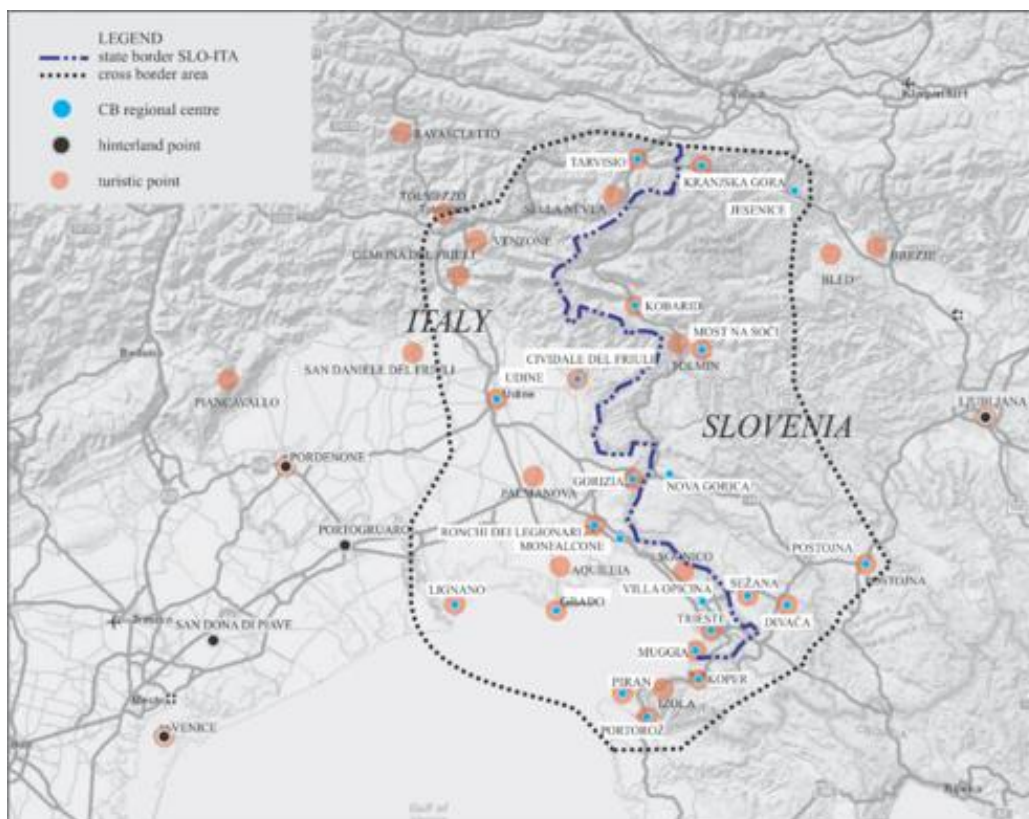

Source: <https://ec.europa.eu/transport/infrastructure/tentec/tentec-portal/map/maps.html> and Prometni institut, d. o. o.

Slovenia offers tourists a wide variety of natural and cultural attractions that with around 5 million of visitors yearly generates a substantial transport demand. Ljubljana is increasing the number of visitors every year. Many daily visits around Slovenia are available from Ljubljana. At the bordering regions with Italy and Croatia many natural karstic landscapes, landmarks and caves are located. The mountainous region along the ITA-SLO border offers mountain trail tourism, farm tourism, white water activities etc. The best-known caves are Postojna Cave and the UNESCO-listed Škocjan Caves. The region of Slovenian Istria meets the Adriatic Sea, where the most important historical monument is the Mediterranean town of Piran. Portorož attracts majority of crowds in summer.

The main tourist attraction point in the CB area are depicted in With 49 % of total population living in the urbanised areas, the main commuting gravitational points of Slovenia have centralised in main urbanised areas. The capital of Ljubljana itself, having more than 280.000 inhabitants, accepts around 130.000 daily commuters. Almost two-thirds of people are employed in services, and over one-third in industry and construction (2016 data). The main industrial centre at the Slovenian side of CB area is Postojna (sanitary ware, toys manufacturing, wood industry); in Nova Gorica, Sežana and Koper a bigger role is played by service supply, especially in transport and logistics.

Tourism is a substantial attractor of transport flows to the CB region. It is a relevant and strongly increasing economic sector on both sides of the border, but with differences with regard to targets (seaside, mountain, and cities), types (leisure, green tourism, cultural trip) and dimensions.

In FVGR many municipalities attract remarkable touristic flows, with particular reference to seasonal tourism at the seaside during summer period (e.g. Lignano Sabbiadoro and Grado), and in the mountains during summer as well as winter period (e.g. Tarvisio, Sella Nevea, Sappada, Ravascletto, Piancavallo). The attractive locations in the region are also archaeological and historical sites with traces of ancient Roman civilisation (e.g. Aquileia, Cividale del Friuli, Palmanova) as well as natural or geological places (e.g. Sgonico, Villanova). The region of Friuli-Venezia-Giulia (FVG) itself attracts about 3 million visitors per year.

Veneto region is well connected to the FVG regional centres and further to Slovenia through dense road and public passenger network. Peak transport demand, which is related to cross-border and long-distance connectivity beyond the region, is recorded in summertime but also in winter towards the mountains. These traffic flows demand good connection of Veneto regional centres to the touristic areas in the region, especially at the seaside and in the mountains. Worldwide known historic and touristic landmarks in Veneto region, especially with Venice Metropolitan City as a flagship, represent main attraction points. Veneto region is as well home to two important international airports such as Venezia and Treviso. San Donà di Piave as intermediate stop point makes a very important hinterland link of the cross-border area passenger transport between Veneto, FVG and Slovenia. From Venice the transport links lead to other Veneto region provinces Verona, Vicenza, Padova and Treviso.

2.3 TRANSPORT SUPPLY - INFRASTRUCTURE NETWORKS

Transportation system is always affected by various interrelations and mutual impacts with other components (settlement patterns, economic system, environment, etc.) of the regional socio-economic context.

Both Slovenia and FVG Region with Vento Region as hinterland areas boast well-developed road and railway transport infrastructure which is located at the crossroads of European transport corridors and connects the biggest CB centres as shown before. Accessibility of the area by air is ensured through international airports Trieste Airport (Ronchi dei Legionari) and a smaller one in Portorož and major airports in the Venice and Ljubljana hinterland area. Water transport is served by international ports in Trieste, Monfalcone, San Giorgio di Nogaro and Koper as well as many smaller parts along the seaside.

2.3.1 Road network

Dense motorway and expressway network, along with other road connections has significantly improved connections and accessibility between parts of the CB area by private cars.

In 2012 the road network in Slovenia extended to a total of 38,985⁵ km, with particularly dense network in the Western Slovenia. The whole Slovenia is connected with 769 km of motorways. Motorways and Expressways in Slovenia are managed by the national company DARS d.d., whereas the other regional and main road network by DRSI⁶

On the other side of the border, in FVGR, the regional road network counts almost 1.100 km of roads, which are mainly owned and directly managed by the Region through the in-house regional company Friuli Venezia Giulia Strade S.p.A. Only 160 km are directly owned and managed by the national road company (ANAS S.p.A.). Highways extend on 280 km and serve access to all the urban areas in its four provinces (Udine, Gorizia, Pordenone and Trieste).

Figure 10: Road network at ITA-SLO cross-border and hinterland area

⁵ INTERREG V-A ITALY – SLOVENIA 2014-2020, CCI 2014TC16RFCB036, Revision 2/2017, approved by the European Commission with Decision No. C (2017)6247 of September 14th, 2017

⁶ Directorate of the Republic of Slovenia for Infrastructure

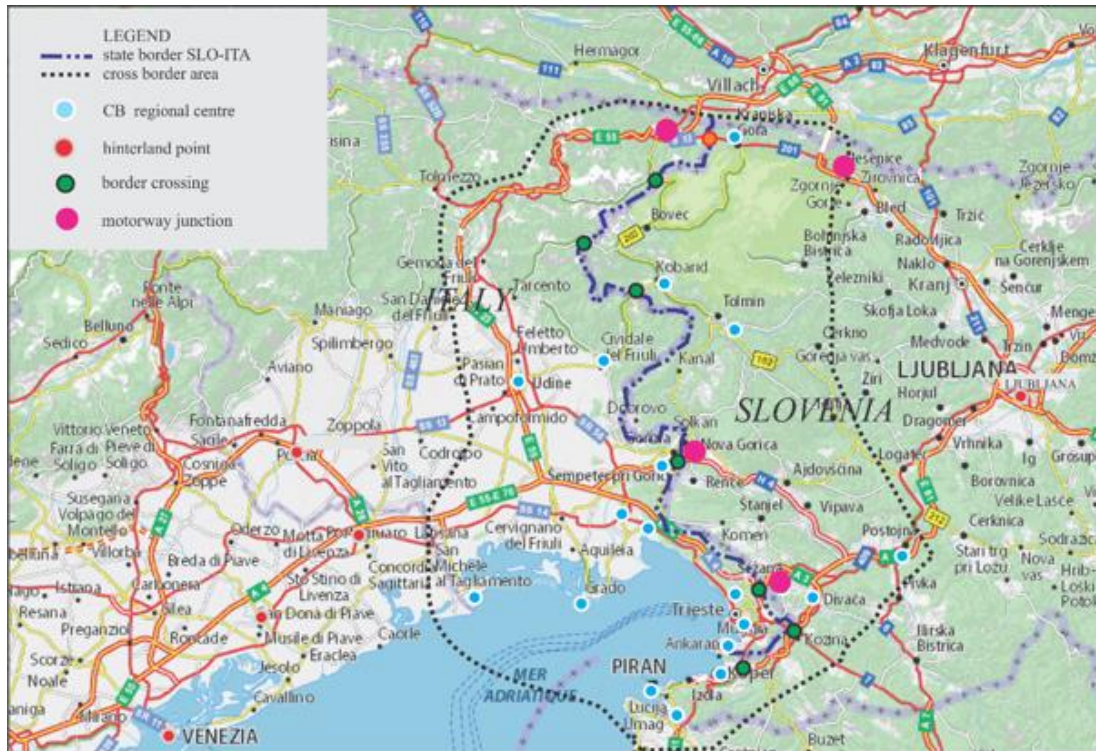

Source: <https://www.viamichelin.com/> and Prometni institut Ljubljana d. o. o.

The motorway network connects all major CB centres in Italy (Tarvisio, Udine, Gorizia, Trieste and Monfalcone) and most of the centres in Slovenia (Jesenice, Postojna, Nova Gorica and Koper).

The two national road networks are connected at 3 motorway or expressway border-crossing points (Škofije/Rabuiese, Fernetiči/Fernetti and Nova Gorica/Gorizia). The fourth connection of the two motorway networks is a cross-border connection by a national road between Jesenice and Tarvisio, stretching at distance of 40 km. There are several minor border crossings, mostly of local importance: Rateče, Ucea/Učja (Bovec), Robič (Kobarid), Predel/Cave di Predil, Dolina/San Dorligo della Valle (Trieste) etc. Many of the smaller border-crossings at the North lead over the mountain passes.

Also the hinterland centres in Veneto are well connected to the centres in FVG region by extensive and heterogeneous multimodal networks serving all modes of land and maritime transport. Veneto region boasts with more than 790 km of motorways, mainly managed concessionaries, which is higher than the national average, and 1.188 railway lines but no high-speed connection (250/km/h), operated by Trenitalia S.p.A. and partly by Sistemi Territoriali S.p.A. Only 14% of travel in Veneto is performed by public passenger service

The dense national road and motorway network as well as many border crossings all along the ITA-SLO border provide good road connectivity of the CB region by personal car as depicted **Error! Reference source not found.** All ITA-SLO CB centres are accessible within 30 min by car. The hinterland centres Ljubljana, Venice or Pordenone are accessible in one hour or one and half hours by car, depending on the starting point within the CB region.

Figure 11: Connectivity of ITA-SLO CB area and hinterland by personal car

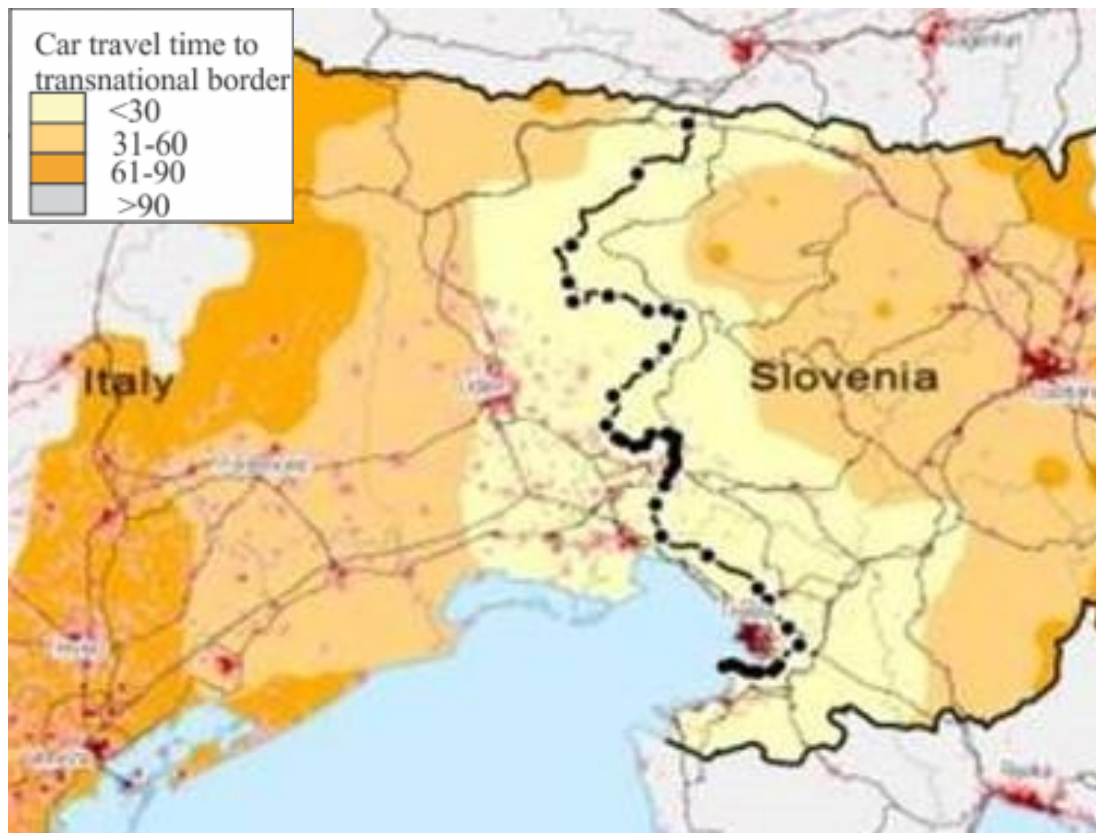

Source: EU Commission, DG REGIO, Border Orientation Paper: ITALY - SLOVENIA, Ref. Ares (2019) 3244965 - 17/5/2019

Road connectivity between regional centres by car is within the medium range in comparison to EU averages except for the Northern part of the Slovenian cross border area, the Northern parts of Udine and Pordenone with worse connectivity.

2.3.2 Public passenger network

In the cross-border area public passenger transport service is supplied in:

- railway transport (extra-urban),
- road transport (urban and extra-urban bus),
- maritime transport (extra-urban ferries),
- airborne transport (domestic and international airports).

Overview of the public transport infrastructure networks is mainly focussed on the railway network (chp. **Error! Reference source not found.**). The road network was discussed in a previous section (**Error! Reference source not found.**), while the maritime transport only requires adequate port infrastructure and related accessibility. The CB area port infrastructure is suitable for mooring large passenger cruisers in Koper, Trieste, Monfalcone and Venice. On both

sides of the border also several smaller ports are capable to accept local coastal passenger ferries, Lignano, Caorle, Chioggia, Grado, Marano, Muggia, Izola, Piran etc.

Figure 12: Port infrastructure of different scope in the CB area

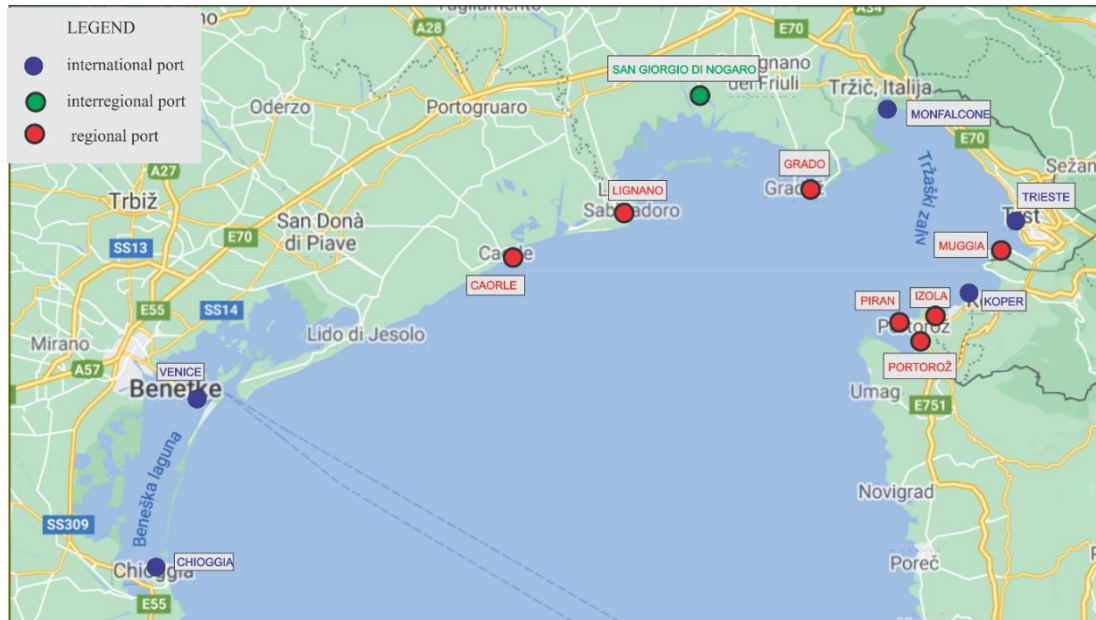

The airports, located in Portorož and Trieste (Ronchi dei Legionari), are important for international and domestic air connection of the region and for tourist accessibility; they don't play a role within CB transport itself but rather the one of a transport hub, particularly Ronchi dei Legionari airport with railway and motorway connection and with many regular domestic and international flight connections.

2.3.2.1 Railway network

In Friuli Venezia Giulia a railway network extends to 472 km of operative rail lines, where 342 km (72%) are categorised as principal lines and 130 km as complementary lines. They are mainly electrified (82%) and double tracked (63%) and served by 38 operative train stations. The main railway stations in the region are presented by Trieste, Udine and Pordenone train stations but also Gorizia, Monfalcone and Cervignano as second most important. They are all included in the "Centostazioni"⁷ renovation initiative. Cervignano del Friuli should be pointed out as an important railway passenger hub as well as a link between Baltic-Adriatic and Mediterranean TEN-T Corridors. It mainly connects passenger services passing from Udine to Trieste and vice-versa but also the CROSSMOBY cross-border train service between Ljubljana, Trieste and Udine.

⁷ Centostazioni S.p.A. is a subsidiary of Italian holding company FS and private partnership, founded in 2001 to redevelop and manage 103 medium-sized Italian railway stations.

The Italian railway infrastructure manager RFI S.p.A. is managing almost all the regional rail network apart from a minor section which it is managed by the regional company Ferrovie Udine - Cividale S.r.l. (in house company of the Autonomous Region of Friuli Venezia Giulia).

The ITA-SLO CB and hinterland area railway network is depicted at **Error! Reference source not found.**

Figure 13: Railway network at cross-border and hinterland area

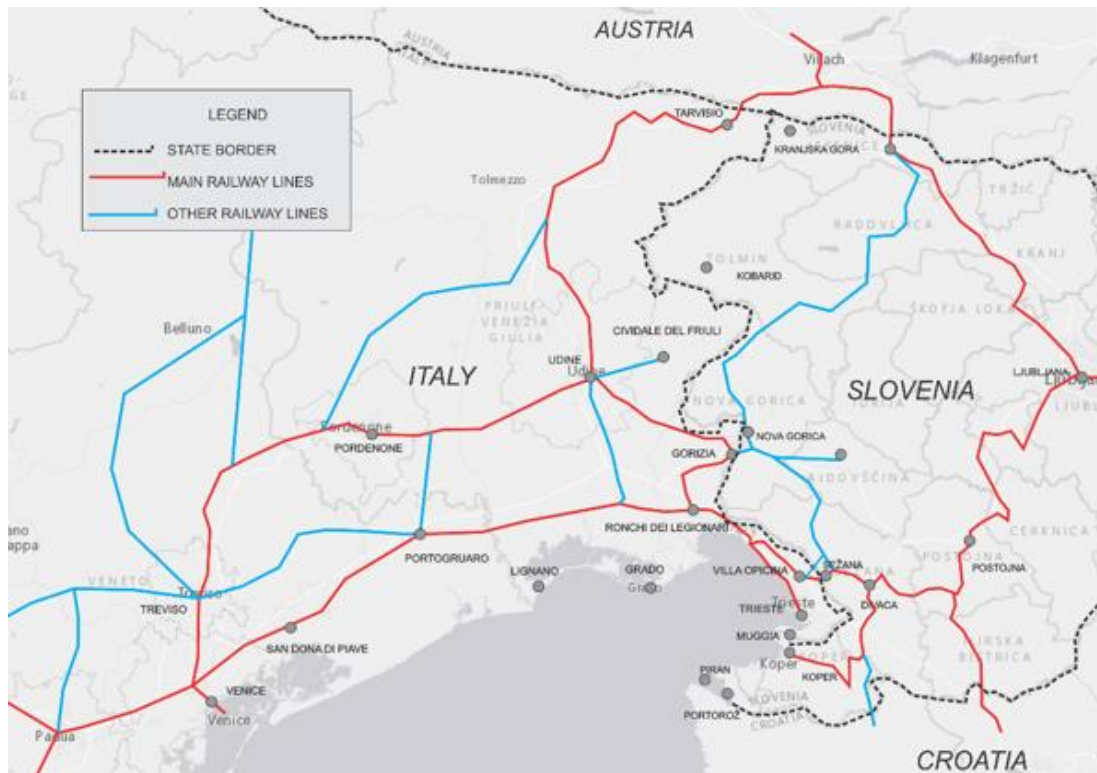

Source: <https://ec.europa.eu/transport/infrastructure/tentec/tentec-portal/map/maps.html> and Prometni institut, d. o. o.

The public railway network in Slovenia comprises a total of 1,208 km of main and regional railway lines, out of which 334 km are double-tracked and 874 km are single-tracked. The railway lines are generally opened for the mixed, passenger and freight, train transport. Only 106 km of railway lines are exclusively open for the freight transport and 2 km only for passenger traffic. Electrification of the Slovenian railway lines is engineered for 3 kV DC with exceptions of short cross-border sections with Austrian and Croatian networks, operating (15 kV, 16.67 Hz) and (25 Hz, 50 Hz), respectively.

Both Slovenia, with its 6 km of railway network per hundred km² of territorial surface, and Italy, with 5,6 km are positioned over the average EU railway density (Europe (EU 5,0 km, 2011)). The

Italian network transported 45.944 million passengers in 2011, the number is still increasing, whereas Slovenia, with 689 million passengers, continues to score a decreasing trend⁸.

Cross-border railway transport lacks good connection of national (regional) railway networks on each side of the railway network. Only two border crossings link national (regional) railway networks along the ITA-SLO border, where only one (Villa Opicina/Sežana) is active for passenger transport. In terms of the percentage of the population having access to cross-border rail services, this was rated in the low range compared to other EU border regions. Also frequency and speed of rail connections is in the low range compared with other EU border regions.

Villa Opicina (IT) and Sežana (SI) railway connection

The only railway passenger transport link exists between Villa Opicina (IT) and Sežana (SI). Both railway networks in Slovenia and Italy share the 15kVDC electrical traction network. However, there are different safety signalling systems; SCMT in Italy and INDUSI in Slovenia. Different safety signalling systems require double signalling system traction units (locomotive and unit trains), currently only available at Italian operator (Trenitalia). **The main issue of train border crossing at Villa Opicina are changing of the train crew and undertaking of certain technical procedures, which takes up to 20 min per stopping,** which is a substantial time overhead for daily commuting purpose.

Figure 14: Cross-border connection at Villa Opicina (IT) - Sežana (SI)

⁸ Cooperation Programme INTERREG V A ITA-SLO - Strategy, June 2015



Source: <https://www.openrailwaymap.org/> and Prometni institut, d. o. o.

Gorizia (IT) - Nova Gorica (SI) railway connection

At the location of Gorizia - Nova Gorica township a railway link exists between Gorizia Centrale station (IT) and Nova Gorica station (SI). The railway link between the stations takes a very long bypass through Šempeter pri Gorici (SI) and is currently only efficiently used for freight train service since the line track layout is inappropriate for efficient connections needed for daily commuting service (see **Error! Reference source not found.**). As a result, the two passenger stations are only connected by bus. As depicted in the **Error! Reference source not found.** a new triangle (planned railway line) is planned close to Gorizia Centrale railway station to allow direct connection of Nova Gorica to Trieste - Udine line and also revival of the triangle near Šempeter pri Gorici that would mainly serve to connect freight terminals on both sides of the national border (<https://www.adriaeco.eu/2019/11/26/la-lunetta-ferroviaria-italiana/>).

Figure 15: Cross-border connection at Gorizia Centrale (IT) - Nova Gorica (SI)

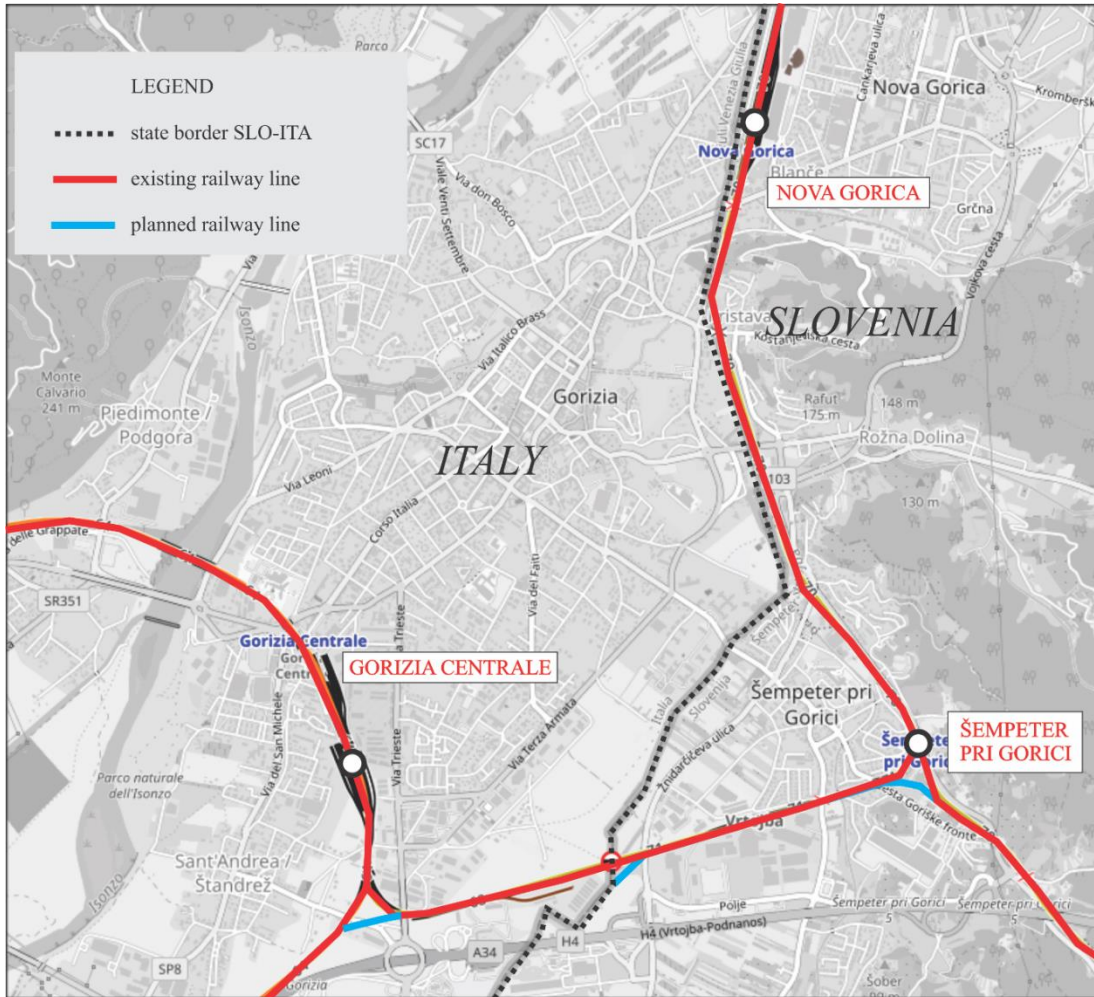

Source: <https://www.openrailwaymap.org/> and Prometni institut, d. o. o.

Nevertheless, the Commission identified the Gorizia - Nova Gorica railway link as the most promising rail connection for development in the Italy-Slovenia border region. (INTERREG V-A ITALY - SLOVENIA 2014-2020, CCI 2014TC16RFCB036, Revision 2/2017, approved by the European Commission with Decision No. C (2017) 6247 of September 14th, 2017).

2.3.3 Modal split

Data on modal split between personal (car) and public transport are not available on the cross-border level. Some data on modal shares are available at regional or country level, but mostly only within the cities. In line with the recorded under average public transport availability in the CB area, comparing to other EU CB regions a conclusion can be made that CB public transport takes a significantly lower share comparing to the listed regional or country level shares.

Observation of mobility in FVGR shows that car transport represents 93 % of regional domestic mobility, with the bus and rail transport only taking 5 % and 2 % respectively. The other transport mode shares are negligible. According to the 2010 data car transport in Slovenia took 86,5 %, regional bus 10,7 % and rail 2,7 %. The TEMS research (The EPOMM Modal Split Tool, 2016)

analysed city transport in Slovenia, showing at least 50 % share for car transport which amounts even close to 70% in Nova Gorica. Sustainable transport in Nova Gorica only records 8 % overall (smaller community), whereas in Koper public transport takes almost 20% and walking nearly 9 %.

For better data on traffic flows as well as on modal split that would allow a solid basis for development of sustainable CB public transport policies a CB traffic flow, additional research and a transport model should be made.

3 PUBLIC PASSENGER TRANSPORT CONNECTIVITY

3.1 ORGANISATION OF TRANSPORT SECTOR

Organisation of public transport is basically different when it comes to internal public transport (local or regional) in the country as opposed to the external transport (international and cross-border lines).

Each country provides a certain level of management and development (development of network, timetables, intermodality, integration...) of internal public transport, regardless the transport mode. They provide co-financing and select transport providers with exclusive rights to operate lines on provided territory and time period.

External transport consists of **cross-border lines** that operate on cross-border area or **international lines** that origin and finish out of the CB area and in the third countries. Border crossing transport is further detailed in the chapter **Error! Reference source not found. Error! Reference source not found.**

Organisation of public transport sector in SLO-ITA CB area will be presented separately for Italian and Slovenian side, respectively.

3.1.1 Italy

Public transport in the border region Friuli Venezia Giulia is structured on a multimodal transport network, operating 6,7 million train km, 42 million of bus km and 52.000 nautical miles (maritime transport). The road, railway and maritime public transport service is managed by the regional authority, which is responsible for PT planning, contracting and financing. As to the railway transport, the region is bound to manage the railway services in compliance with General directorate for “infrastructures, logistics and transport services” authorised by the national government. Friuli Venezia Giulia, being an autonomous region, is endowed with particular competences within the Italian legislative framework, esp. with reference to cross-border transport planning.

Bus and maritime services are provided by a single transport operator (TPL FVG Scarl), which has joined 4 former transport companies, now part of the consortium TPL FVG Scarl and is covering the whole transport network, as indicated in **Error! Reference source not found.**

In 2014 an international tender in line with the Regional plan of public local transport (“Piano Regionale del Trasporto Pubblico Locale”) was opened by the FVG regional government to award the transport service to a single transport operator that would follow the intention of the region to provide an integrated multimodal transport in the region. The Contract between RFVG and “TPL FVG Scarl” was signed on 15.01.2019 for 10 years, this date being also the official start of operation of the selected transport operator. The TPL FVG is a consortium of 4 public transport companies that are the four former transport operators having provided the service in provinces

of the region up to now. Each transport company provides transport services in one of the four provinces of the FVG region, as indicated in Table 1: Road and maritime transport operations in Friuli Venezia Giulia by TPL FVG

. Currently, the consortium of partners keeps on going with the established services but the services will gradually undergo the needed transformation aiming at better transport integration in the whole region and even beyond the borders.

Figure 16: Transport companies, forming a new PT operator TPL FVG Scarl

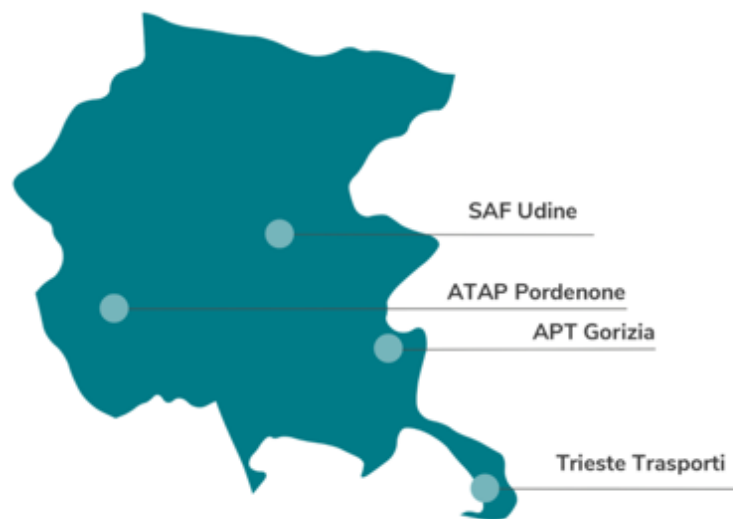

Table 1: Road and maritime transport operations in Friuli Venezia Giulia by TPL FVG

Province	Transport operator	Local service	Cross-border service
Gorizia	TPL FVG (former APT Gorizia S.p.A.)	- urban & extra urban bus - local maritime	- bus Gorizia - Nova Gorica
Pordenone	TPL FVG (former ATAP S.p.A.)	- urban & extra urban bus	/
Trieste	TPL FVG (former Trieste Trasporti S.p.A.)	- urban & extra urban bus - local tram - local maritime	/
Udine	TPL FVG (former Autoservizi F.V.G. S.p.A. - SAF)	- urban & extra urban bus - local maritime	/

Train transport in the region is serviced by a national and a regional railway transport operator.

Table 2: Train transport operators in Friuli Venezia Giulia

Region	Transport operator	Regional service	Cross-border service
Friuli Venezia Giulia	Trenitalia S.p.A.	- majority of regional services	Trieste - Ljubljana (CROSSMOBY)
	Ferrovie Udine - Cividale	- Udine - Cividale del	- Villach - Udine -

	S.r.l.	Friuli	Trieste (MICOTRA)
--	--------	--------	-------------------

Analog organisation of optimization, verification and monitoring of public transport as in FVG Region is also provided in the Veneto Region, where a new regional plan provides commitment to the integrated, multimodal and multi-operator public transport⁹.

Infomobility and integration of the transport are presented in separate sections.

3.1.1.1 Infomobility

By selecting a single transport operator for the whole Friuli Venezia Giulia Region also a single uniform infomobility system has been developed covering transport services in the entire FVG Region. The new infomobility system has replaced separate and fragmented infomobility systems kept by the province operators. The new infomobility system will be particularly convenient when travelling across the province limits or further. Before, only limited province overlapping information on timetables was available.

It is worth mentioning that ATVO, a Veneto Region transport operator, is also providing bus services in Friuli Venezia Giulia by connecting FVG centres to the centres in Veneto Region. Train transport is operated by the national railway company Trenitalia and a regional operator Ferrovie Udine - Cividale (FUC).

Each transport operator has developed its own web travel planner. All of them also developed corresponding mobile apps. Trenitalia provides a web travel planner and a mobile app providing pre-trip and on-trip information. FUC provides static web timetables. Modernisation of the services are going on, including completion of stops and on-board messaging system. Overview of infomobility system functionalities is given in the **Error! Reference source not found.**

Table 3: Features of infomobility systems by transport providers

	TPL FVG	TRENIT ALIA	FUC	ATVO
Pre-trip travel information system	X	X		X
On-trip travel information system	X	X	X	X
Search connection by address	X	X		X
Search connection by stop	X	X		X
Search connection by POI	X			
Schedule	X	X	X	X
Route planner	X			X
Travel time	X	X	X	X
Transfers		X		X
Fares	X	X	X	X

⁹ Regional Economy and Finance Document DEF 2017-2019 (thematic area “Mobility”)

Linked static timetables	X	X	X
Linked timetables per stop	X	X	X
Online ticketing/payment		X	X

Travel information by the transport operators is available on the web pages listed in the table below.

Table 4: List of infomobility system links provided by transport operators

Transport operator	Web infomobility system
TPL FVG	https://apps.apple.com/it/app/tplfvg/id1481314758 https://play.google.com/store/apps/details?id=net.pluservice.tplfvg
TRENITALIA	http://www.viaggiatreno.it/viaggiatrenonew/index.jsp
FUC	http://www.ferroviudineciviale.it/
ATVO	http://www.atvo.it/it-orari-e-autolinee.html

There are also interregional web infomobility systems which are not directly linked to the operators. They partly overcome fragmentation of long-distance travels. They connect timetables and services but also provide **intermodal** information. Some infomobility systems:

- <http://www.mycicero.it/> (train + bus services)
- <https://www.trainline.it> (train + bus services)
- <https://www.logitravel.it/> (train services)
- <https://www.logitravel.it/> (train services)
- <https://www.goeuro.it> (train + bus services)
- <https://www.wanderio.com> (train + bus services)
- <https://www.busradar.it> (bus services)
- <https://www.checkmybus.it> (bus services)

3.1.2 Slovenia

Public passenger transport in Slovenia is regulated by several sectoral laws, regulating each mode of transport separately, i.e. bus, trains, waterborne and cableways. Regulation provides shared financing and management of passenger transport between local level and state. Municipalities through departments for transport organize and finance urban transport on their territory and partially co-finance extra-urban buses. Extra-urban and regional bus and train transport is managed by the Public Transport Department at the Ministry of Infrastructure and by the Government of Slovenia. Public passenger transport (PPT) in the country at the national level is provided as public service obligation whereas at the local level both options take place, as obligation or optional service. Bus service is awarded as a concession.

Cross-border and international bus lines subject to commercial initiative but must be registered at the Ministry of Infrastructure (Road Transport Section). The Ministry have no control over the actual operation of the registered lines. International train lines are agreed upon on annual international railway conferences whereas the cross-border train lines are negotiated between the neighbouring railway authorities. The segments of the international/cross-border railway lines

running on Slovenian railway network are all co-financed by the Slovenian Government through PSO instrument.

Volume of bus operators in Slovenia is in process of consolidation. Currently, 26 bus operators and 1 train operator (SŽ-Potniški promet, d.o.o.) operate internal public passenger transport in Slovenia. Cross-border and international transport service is provided by 14 bus operators and 1 train operator (SŽ-Potniški promet, d.o.o.) from Slovenia.

Cross-border area bus transport lines are mainly operated by 2 operators:

- ARRIVA Dolenjska in Primorska d.o.o. and
- Nomago d.o.o.

The long bus lines in the area are also operated by 2 more bus operators:

- ARRIVA Alpetour d.o.o. and
- APMS - Avtobusni promet Murska Sobota d.d.

and some smaller bus operating companies in the area.

LPP d.o.o., a Ljubljana transport operator, has to be pointed out as an urban and extra-urban bus operator in Ljubljana hinterland city and its surroundings.

Urban transport in Slovenia exists in 16 municipalities, 7 of them in the cross-border area or hinterland area (Koper, Piran, Nova Gorica, Idrija, Jesenice, Postojna and Ljubljana - PSO).

3.1.2.1 Infomobility and ticketing

Each transport operator on Slovenia provides its own sales network which is a constituent of a single integrated national sales network. Transport operators also provide their own ticketing systems which are also integrated to a single national ticketing system.

Each transport operator provides their own infomobility system. All infomobility systems provide pre-trip information: a map of lines (or routes), timetables, travel times and additional services, trip planning based on origin and destination as well as information on station facilities and vehicles. LPP bus operator also provides on-trip information on buses and bus stops.

Practically all infomobility systems are available in Slovenian and English language, with additional information on cross-border lines also in local language (e.g. Italian). All infomobility systems are planned to extend availability of languages.

Table 5: List of Slovenian international and cross-border lines operators

SŽ - Potniški promet	https://www.slo-zeleznice.si/sl
LPP	https://www.lpp.si/
Arriva	https://arriva.si/
Nomago	https://www.nomago.si/vozni-red
APMS	https://www.apms.si/voznired

Operators in all modes of transport accept paper tickets, except of Ljubljana city transport where only electronic tickets, stored on smart card or NFC smart phones, are available (users of mobile phone can also buy a ticket on the bus by using voice data transfer - ref. Moneta). Also entitlement to railways transport in Ljubljana urban area is only stored on a smart card. Smart cards are actually issued by all operators when it comes to periodic travel passes. Barcode is used mainly as a security element on general type and print@home paper tickets.

On-line payment is a common practice for all operators, mostly for periodic passes and print@home tickets.

Integration of the transport is addressed in a separate section.

3.2 REGIONAL PUBLIC TRANSPORT CONNECTIVITY

Regional public transport connectivity also plays a role in cross-border connectivity when studying possibilities of extension of regional lines or link of regional networks.

Regional public transport denotes *internal regional and local transport* on each side of the cross-border line, respectively, and *connection to the hinterland centres* in the respective country (Italy and Slovenia).

Italy and Slovenia boast dense bus transport network that connects regional gravitational centres and other points of interest in each country. Bus transport is flexible and can easily adapt to the actual demand, therefore it can be concluded that the number of bus lines and frequency of bus connections is well managed by the authorised managers at state, regional and local levels as well as by the selected concessionaries in both countries. Extra-urban bus service is available in all observed points of interest in cross-border and hinterland area. According to that, extra-urban bus lines will not be scrutinised in detail. Analysis of extra urban lines is only limited to the lines that connect (start or lead through) CB and hinterland centres to the border points.

In the study the data on the bus lines from CB and hinterland centres have been analysed for Slovenia to show the approach to line identification. Any further analysis requires involvement of local territorial needs and a detailed investigation of the existing regional urban and extra-urban bus lines that can be extended to CB or hinterland centres across the border.

Table 6: Slovenian regional extra-urban bus lines leading through CB centres and terminating at border crossings

CB CENTRES	BORDER CROSSINGS		No. LINES	No. DEPARTURES
Divača	Sežana	Nova Gorica	17	27
Jesenice	Rateče Planica		11	66
Nova Gorica	Sežana		7	48
Piran	Nova Gorica		5	7
Portorož	Nova Gorica		6	9
Postojna	Nova Gorica	Sežana	15	44

Sežana	Nova Gorica			17	36
Ljubljana	Nova Gorica	Sežana	Rateče Planica	14	68
Koper	Nova Gorica	Sežana		12	16
Kranjska Gora	Rateče Planica			9	44
TOTAL				74	250

Error! Reference source not found. lists the number of lines that connect CB and hinterland centres on Slovenian side to the border-crossing points and departures in both directions (pairs) on those lines. These lines are the possible candidates for the extension across the border. All CB and hinterland centres in Slovenia have good regional connectivity to the cross-border, except coastal towns Piran and Portorož, and therefore good potential for new CB lines by extension. All the lines are only operated by two transport operators NOMAGO and ARRIVA. The same analysis of regional bus lines should be performed for the Italian extra-urban or urban bus lines when studying a particular situation at the cross-border connectivity.

Level of railway network development is more diversified, especially it lacks connections in hilly and mountainous parts of the cross-border area with smaller and more scattered settlements.

Urban transport is available in larger municipalities with the power to connect city centre to the points of interest scattered around the municipal area:

- Italy: Trieste, Udine, Monfalcone, Gorizia
- Slovenia: Ljubljana, Postojna, Koper, Nova Gorica

Two transport operators, one from Gorizia and one from Nova Gorica serve the whole township of the joint cross-border city area by overlapping their urban lines, thus providing better frequency of departures.

Figure 17: Railway transport and city transport service availability in CB and hinterland area

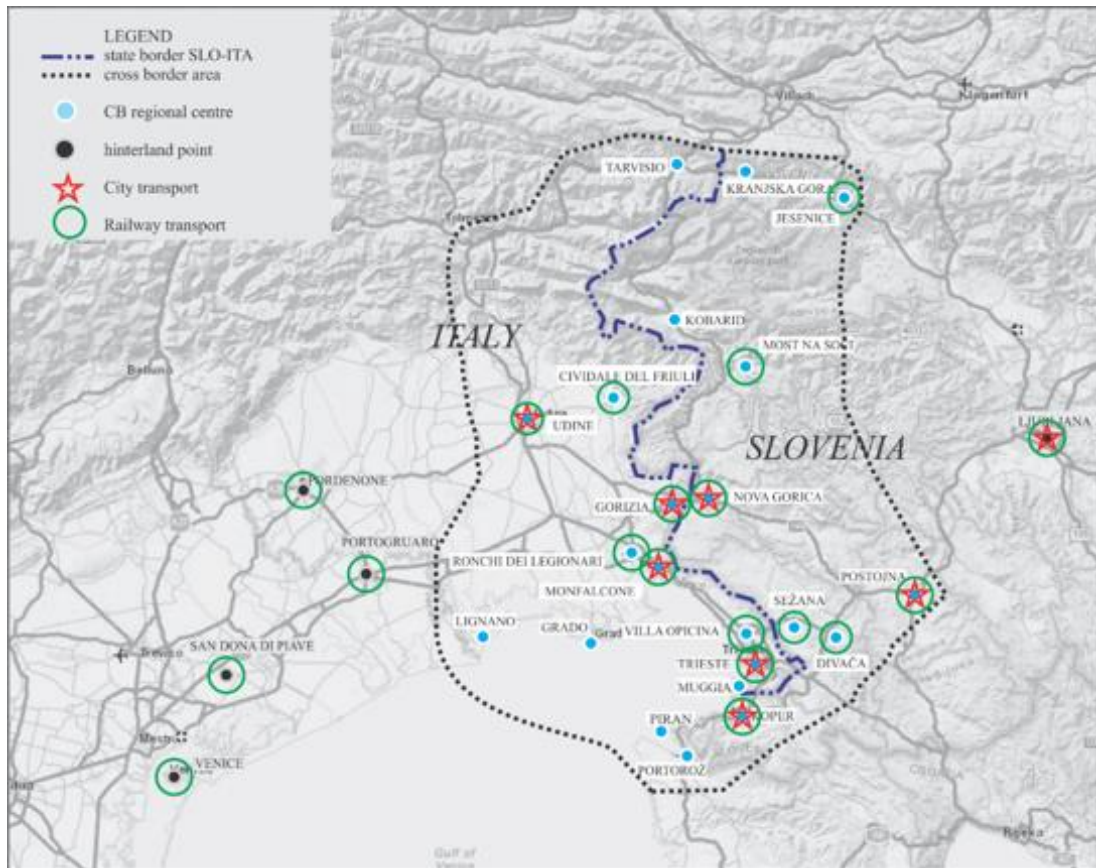

Source: <https://ec.europa.eu/transport/infrastructure/tentec/tentec-portal/map/maps.html> and Prometni institut, d. o. o.

Intermodality of public transport is possible in the CB centres where several transport modes exist. Intermodality can be established among regional/urban railway, extra urban and urban bus systems where bus lines should generally adapt to the more rigid railway network (transfer of bus stops locations if necessary). Since extra-urban bus transport is available for all CB centres, the **Error! Reference source not found.** only shows availability of urban bus transport and extra-urban railway transport service in CB area, thus showing the CB centres where intermodality is an option. A detailed research of the particular intermodality situation should be carried out for each location where the option exists.

Availability of regional railway transport supply as a mass transport backbone was further analysed in order to be able later on identify the missing infrastructure links and missing lines to connect regional railway transport in each country to one intermodal cross-border transport (3.3.1.4. Intermodal transport)

Railway transport supply in each country was investigated in terms of number of train pairs (departures to each direction) and level of train service between regional centres and further to hinterland centres on a daily basis (Table 7):

- on a week day (Tuesday),
- on a weekend day (Sunday),
- availability of train service (RT - regional train, LT - local train).

Connectivity by train during the week is focussed on daily commuters for work or study purpose whereas Sunday connectivity considers merely leisure travel.

To investigate the total number of railway links on each point both, rows and columns in the table should be checked (Table 7).

Table 7: Number of daily railway connections and level of service between regional centres and links to hinterland centres

Railway station	Divača	Koper	Sežana	Nova Gorica	Kobarid	Most na Soči	Kranjska Gora	Jesenice	Piran	Portorož	Postojna
Koper	5/5/RT										
Sežana	14/7/LT	4/4/LT									
Nova Gorica	6/2/LT	3/2/LT	5/3/LT								
Kobarid	0	0	0	0							
Most na Soči	2/2/LT	3/2/LT	3/2/LT	8/8/LT	0						
Kranjska Gora	0	0	0	0	0	0					
Jesenice	12/5/LT	4/4/LT	13/7/LT	7/6/LT	0	7/6/LT					
Piran	0	0	0	0	0	0	0	0			
Portorož	0	0	0	0	0	0	0	0	0		
Postojna	17/9/RT	4/5/RT	14/7/LT	5/2/LT	0	6/4/LT	0	17/12/LT	0	0	
Ljubljana	17/9/RT	4/5/RT	14/7/LT	12/6/LT	0	7/5/LT	0	18/12/LT	0	0	19/12/RT

For each point of interest see both: row and column.

Railway station	Trieste	Muggia	Udine	Gorizia	Ronchi dei Legionari	Monfalcone	Villa Opicina	Tarvisio	Cividale del Friuli	Grado	Venice	Pordenone	Portogruaro	San Donà di Piave
Muggia	0													
Udine	25/22/R T	0												
Gorizia	22/20/R T	0	23/19/R T											
Ronchi dei Legionari	11/11/R T	0	16/11/R T	15/11/R T										
Monfalcone	55/38/R T	0	32/21/R T	23/19/L T	13/10/LT									
Villa Opicina	2/2/RT	0	1/1/RT	1/1/RT	1/1/RT	0								
Tarvisio	7/9/RT	0	7/8/RT	6/6/RT	9/7/RT	8/9/LT	4/1/RT							
Cividale del Friuli	16/17/L T	0	15/16/L T	15/17/L T	16/11/LT	12/12/LT	4/2/LT	6/9/LT						
Grado	0	0	0	0	0	0	0	0	0					

Venice	33/29/R T	0	33/25/R T	25/20/R T	18/18/RT	15/15/LT	4/2/RT	6/8/RT	13/13/R T	0				
Pordenone	21/16/R T	0	31/24/R T	16/12/R T	18/10/RT	20/11/LT	6/2/RT	6/8/RT	13/13/R T	0	32/23/R T			
Portogruaro	19/17/R T	0	25/26/R T	20/16/R T	13/12/RT	18/17/LT	4/2/RT	5/11/RT	11/13/RT	0	36/31/R T	20/28/R T		
San Donà di Piave	19/19/R T	0	26/34/R T	13/24/R T	10/14/RT	16/16/LT	4/2/RT	5/13/RT	18/20/RT	0	35/31/R T	26/20/R T	35/31/RT	
Lignano	0	0	0	0	0	0	0	0	0	0	0	0	0	0

For each point of interest see both: row and column.

Source: <https://app.italiarail.com/results>, <https://www.trenitalia.com/en.html> (for each point of interest see row and column)

Table 7 is split in two, upper table shows regional train connections in Slovenia, the table below in Italy. The centres pertaining to the CB area are in green font, whereas the hinterland centres in red. Data in the cell present: “*week connections/weekend connections/level of service*”. Level of service is marked as RT for regional train service, e.g. regional train, or LT if only local train is available. At the moment high speed train service is not present in the area.

In Slovenia Koper, Sežana, Nova Gorica, Postojna, Jesenice and Divača, i.e. 6 observed CB points out of 11 on the Slovenian side have direct connection to the railway network and further connection to the hinterland centres of Postojna and Ljubljana. The points without railway lines, i.e. Kobarid, Kranjska Gora, Piran, Most na Soči and Portorož, are smaller settlements, but important places of tourist interest in the mountains and seaside areas. Beside extra urban bus connection to the regional and CB centres the railway network can be accessed through local bus/train intermodal points (Most na Soči, Jesenice and Koper). Regional train connections only exist in Divača, Koper, Sežana and Jesenice. A careful itinerary planning is necessary for daily commuting since the number of daily connections is usually up to 5 trains in one direction. Ljubljana as a big hinterland centre has good railway connection to other CB centres in Slovenia.

Situation on the Italian side is better. 10 CB and hinterland points out of 14 have direct access to the railway network, and except of Cividale del Friuli all provide regional train service. Only 3 seaside settlements Muggia, Grado and Lignano use bus link to the railway network hubs in Trieste, Cervignano or Latisana (Lignano). Udine, Gorizia, Trieste Airport and Cividale del Friuli offer frequent regional train connection with all main hinterland centres in FVG Region and Veneto, from 13 to 33 daily connections in one direction. Villa Opicina border station as well as Tarvisio, a smaller local centre without cross-border railway connection to Slovenian network only provide few daily services. Inside the CB area frequent service is provided between Udine and Gorizia and their connection to the Trieste Airport and Cividale del Friuli. Villa Opicina border station suffers poor connectivity also inside the CB region with only 1 or 2 pair of daily trains to the main regional centres Trieste, Udine and Gorizia; as mainly transit point it is better connected to Veneto hinterland centres. Hinterland centres Venice, Pordenone and San Donà di Piave are very well connected to the FVG Region by train.

Graphical presentation of important regional train destination is available in chapter 3.3.1.4 (Intermodal transport), where also intermodal connections of split regional railway transport is suggested.

Regular local maritime lines are only available in Italy but they are not analysed in detail for they don't represent a mass public transport, they are only available along the coastal line and are not considered interesting for establishing a daily intermodal commuting service.

Dense regional public bus and railway transport network provides good service per each mode, whereas setting up intermodal connections still deserves a lot of attention on both sides of the border.

3.3 CROSS-BORDER PUBLIC TRANSPORT CONNECTIVITY

The aim of analysis of cross-border public passenger transport connectivity is to present the current level of connectedness by public transport service for regional centres in the ITA-SLO cross-border area and centres from the larger hinterland to the cross-border area and to the regional and hinterland centres on the other side of the common border (other country).

The connectivity was studied in terms of operation of cross-border transport and in number of connections and daily, weekly and seasonal departures among the points of interest (PoI), travel time-wise efficiency of public transport, availability of transport modes and intermodal connectivity.

Cross-border connectivity is characterised by the transport lines that connect points of interest and centres in the gravitational area (vicinity) around the ITA-SLO national border, on both sides, thus serving also the entire Programme area including Veneto. Two types of transport lines are subject of the cross-border connectivity analysis:

- **international lines:** origin or destination of the lines are outside of the cross-border area, the operator is not necessarily from Italy or Slovenia, the lines tend to cross several countries;
- **cross-border lines;** origin and destination of the lines are in the cross-border or hinterland area or they have a lot of stops in the CB area; line frequency is adapted to the daily commuting or tourist visits (regular and frequent departures) in the CB area.

Cross-border transport is mainly characterised by the extra-urban bus and railway lines.

The only existing **urban cross-border transport** is a city transport in the cross-border township of Gorizia on Italian side and Nova Gorica on Slovenian side where city (municipal) bus operators, one from each country, mutually provide service on both sides of the state border that is dividing the township.

An example of experimental urban transport taking part in cross-border line is a **combined transport** service between Ljubljana (SI) and Trieste (IT), which is composed of two legs; namely a cross-border *train service* between Ljubljana and Villa Opicina (IT) (leg 1) and a connection to the *city bus* transport from Villa Opicina to the centre of Trieste (leg 2). The combined transport service between Ljubljana and Trieste was launched in 2019 as a pilot action within the CONNECT2CE EU project. The combined ticket was embraced by occasional and regular passenger on the route and has options to further capitalization¹⁰.

Considering cross-border and hinterland centres, also connections to the larger area of the centres was taken into account if considered appropriately (the locations around the centres);

¹⁰ The service is currently suspended, mostly due to restructuring of Trieste city bus operator.

namely a location of Venice also includes Mestre and Treviso, while a location of Nova Gorica also comprises Šempeter pri Gorici.

3.3.1 Order crossing lines

The term “border crossing lines” denotes both, cross-border and international lines in line with the definition in chapter **Error! Reference source not found.**.

According to the EU and national legislation cross-border public transport lines are considered commercial lines, except for railway and partly ferry lines which are included to the national PSO contracts whereby also co-financing is provided. The stated also applies to Slovenia, whereas the situation is different in Italy and in turn in FVG Region. Italy subsidizes ticket price for any cross-border services, thus being considered part of public service obligation, the subsidies are currently only applied to train service. This makes it possible to achieve more attractive cross-border ticket prices and promotion of cross-border public transport, which should eventually be extended to other transport modes.

For there is no or scarce management of operation of border crossing lines at the municipal, regional or national level, the passengers are faced with dispersion of information and accessibility of transport services. This makes a big issue in the environment of quite diverse and abundant border crossing transport service, especially in bus transport.

Several information platforms, providing cross-border public transport information, already exist (e.g. www.rome2rio.com) but they are not complete¹¹ or updated promptly. There are also ongoing or recently completed projects that address cross-border infomobility issues (e.g. LINKING DANUBE <http://www.interreg-danube.eu/approved-projects/linking-danube> LINKING ALPS <https://www.alpine-space.eu/projects/linkingalps/en/home>) and overcome a need for a unique and comprehensive cross-border infomobility system that would offer complete information on cross-border lines to the passengers about the transport services, either per transport mode (e.g. a bus information system) or jointly for several transport operators. Each transport operator published information on its own transport lines only whereas big information portals often lack completeness of information. The information is usually available on the operator’s web page and additionally at the ticket sale points only.

While railways and ferry boats restrict ticket purchase to the on-line sale and stationary points of sale (over the counter), buses also offer on-board ticket sale if non-occupied bus seats are available. In bus border crossing transport an obligation of seat reservation is usual, especially for long-distance international lines.

Despite no particular restriction, some border crossing lines feature or are allocated for specific passenger categories like pensioner, workers etc. especially workers’ lines timetables are optimised according to the specific needs of this transport. The lines for general population are

¹¹ E.g. the bus line from Most na Soči to Kranjska Gora via Tarvisio is not recorded.

usually moderately occupied. Many of them have not been operating recently due to the Covid-19 pandemic.

3.3.1.1 Railway transport

Slovenian and Italian CB and hinterland centres are directly connected by the only railway line, connecting the two national railway networks. It extends from Ljubljana via Postojna and Sežana to finish, either in Villa Opicina, Trieste or Udine.

On week days 6 trains run from Ljubljana to Villa Opicina, 3 on Saturdays and 4 on Sundays. 4 trains are available on the way back from Villa Opicina to Ljubljana during the week and only 3 on Saturdays and Sundays.

Ljubljana, Postojna and Sežana are linked to Trieste by 2 train pairs on a daily basis, one of them also connecting the Slovenian CB centres with Ronchi dei Legionari airport (near Trieste) and Udine in Italy. Level of connectivity of Ljubljana by train to Italy cannot be considered adequate to accommodate daily commuters or even satisfy airport travellers to Trieste airport.

Cross-border connectivity among Villa Opicina, Sežana and Postojna is very good with 8 pairs of trains during the week days, 6 on Saturdays and 7 on Sundays.

Cross-border railway connectivity is presented in **Error! Reference source not found.** and **Error! Reference source not found.**

Table 8: Direct CB railway connections: week day/Saturday/Sunday

	Villa Opicina	Trieste	Ronchi d. Legionari	Udine
Ljubljana	6/3/4	2/2/2	1/1/1	1/1/1
Postojna	8/6/7	2/2/2	1/1/1	1/1/1
Sežana	8/6/7	2/2/2	1/1/1	1/1/1

operator, Ljubljana is actually connected with Venice¹³ by FLIXBUS and NOMAGO operators, appx. once an hour, which makes a considerably lower number.

In order to reasonably limit the number of connections 2 separate analyses of number of lines and departures are presented, one taking into account all registered lines and the other only cross-border lines, in line with the definition in chp. **Error! Reference source not found.** 28 CB lines were identified. Those lines are mostly confined to the cross-border and hinterland area, only four of them originate or finish further in Italy (Milano, Ancona and Sienna) but have many stop in the CB area. Details are presented in **Error! Reference source not found.**

Table 9: International and CB lines - number of operators and lines

From	All international lines		Cross-border lines	
	Num. operators	Num. lines	Num. operators	Num. lines
Slovenia	14	28	13	26
Italy	4	20	1	2
Other countries	9	13	0	0
TOTAL	27	61	14	28

International lines are operated by 27 operators, 14 from Slovenia, 4 from Italy and 9 from third countries (Croatia, Austria, Hungary, Bulgaria, Germany, France, Romania and Poland). Almost half of the lines, 28 out of 61, are determined as CB lines. The identified CB lines are mostly operated by Slovenian bus operators.

Full list of transport operators is available in Appendix on page 88.

The analysis is focussed on connections between the cross-border and hinterland centres at the opposite sides of the state border although the cross-border and international lines also connect the centres at the same side if the border. It is deemed that the connections between the centres in the same country are adequately served by local and regional transport service and are therefore not closely studied.

Some cross-border lines don't connect any of the analysed cross-border centres and hubs but rather small places like villages, e.g. Štanjel - Duino line that connects Slovenian villages to the smaller sea resorts in Italy.

5 border crossing lines only operate during the summer time:

- CROSSMOBY pilot line¹⁴: Most na Soči, Kobarid, Bovec, Tarvisio, Kranjska Gora - Ljubljana (2x daily)
- Rateče - Tarvisio - Bovec (Monday to Saturday)

¹³ Especially number of Ljubljana - Venice connections is subject to great uncertainty because it is operated by many operators out of the ITA-SLO countries, due to commercial interest of this particular connection.

¹⁴ CROSSMOBY, INTERREG V A, Italy - Slovenia, 2014 - 2020: pilot line - extension of the existing line Bovec - Tarvisio - Kranjska Gora - Ljubljana

- Štanjel - Duino (Sundays and holidays)
- Venice - Sežana - Postojna - Ljubljana (week days)
- Vigevano (IT)-Pula (CR) (weekend connection of Italian and Istrian towns in Slovenia and Croatia.).

CB connectivity by international and cross-border lines is presented in the following tables and figures that analyse the number of international and cross-border lines, departures and transport time.

Table 10: Cross-border connectivity - number of lines connecting CB and hinterland centres

	Divača	Koper	Sežana	Nova Gorica	Kobarid	Most na Soči	Kranjska Gora	Jesenice	Piran	Portorož	Postojna	Ljubljana
Trieste	0/0	10/9	7/4	0/0	0/0	0/0	0/0	0/0	1/1	4/3	6/4	19/4
Muggia	0/0	0/0	0/0	0/0	0/0	0/0	0/0	0/0	0/0	0/0	0/0	0/0
Udine	0/0	0/0	3/0	0/0	0/0	0/0	0/0	0/0	0/0	0/0	2/0	7/0
Gorizia	0/0	0/0	0/0	1/1	0/0	0/0	0/0	0/0	0/0	0/0	1/1	3/1
Ronchi dei Legionari	0/0	0/0	0/0	0/0	0/0	0/0	0/0	0/0	0/0	0/0	0/0	2/0
Monfalcone	0/0	0/0	1/0	0/0	0/0	0/0	0/0	0/0	0/0	0/0	0/0	0/0
Villa Opicina	0/0	0/0	1/1	0/0	0/0	0/0	0/0	0/0	0/0	0/0	0/0	0/0
Tarvisio	0/0	0/0	0/0	0/0	1/1	1/1	1/1	0/0	0/0	0/0	0/0	1/1
Cividale del Friuli	0/0	0/0	0/0	0/0	0/0	0/0	0/0	0/0	0/0	0/0	0/0	0/0
Grado	0/0	0/0	0/0	0/0	0/0	0/0	0/0	0/0	0/0	0/0	0/0	0/0
Lignano	0/0	0/0	0/0	0/0	0/0	0/0	0/0	0/0	0/0	0/0	0/0	0/0
Venice	0/0	6/5	6/3	4/3	0/0	0/0	0/0	0/0	0/0	3/2	6/4	33/10
Pordenone	0/0	0/0	1/0	0/0	0/0	0/0	0/0	0/0	0/0	0/0	1/0	1/0
Portogruaro	0/0	0/0	1/0	0/0	0/0	0/0	0/0	0/0	0/0	0/0	0/0	0/0
San Donà di Piave	0/0	0/0	0/0	0/0	0/0	0/0	0/0	0/0	0/0	0/0	0/0	1/0

Table 10 shows that only the most important cross-border centres from the opposite sides of the state border, less than 15% of the analysed CB and hinterland centres, are connected to each other by the border crossing lines (14%: by international lines - 26/180; 11%: by CB lines - 19/180).

Good connectivity is available for Trieste and Venice in Italy to Koper, Sežana, Portorož, Postojna and the hinterland city of Ljubljana in Slovenia. There is no direct connection from Slovenia to Italian coastal centres Muggia, Grado and Lignano. Beside the smaller agglomerations that are only connected by mountain passes in hilly areas (Tarvisio - Kranjska Gora, Kobarid - Cividale del Friuli), also bigger centres Udine and Gorizia have relatively few CB connections. Example of good CB connectivity is city transport between Gorizia and Nova Gorica, which provides 20 connections daily by joint venture of Slovenian operator NOMAGO City (<https://city.nomago.si/nova-gorica-vozni-red>) and Italian municipal bus operator TPL FVG.

The best connectivity is observed on the route Venice - Ljubljana, by 10 CB lines and additional international lines (33 in total).

Figure 19: Map of cross-border and international public bus lines

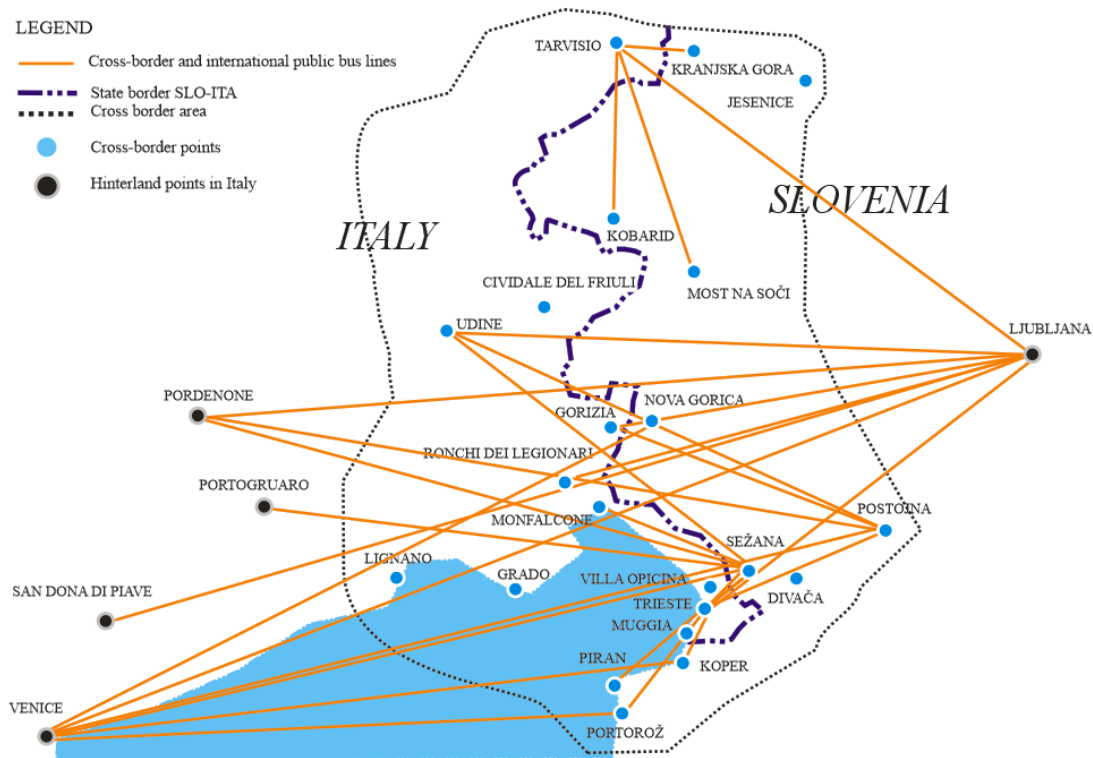

Figure 19 shows the available cross-border connections that connect CB and hinterland centres as presented by number of lines in Table 10. CB centres in the southern plain area are far better connected as the CB centres to the north in hilly, mountainous and agricultural area. The area to the north is on the other hand very interesting for summer and winter tourist activities and should be subject to consideration for better public transport connectivity. Bad CB connectivity is also observed at Italian coastal towns Lignano, Grado and Muggia.

Table 11: CB centres connectivity- number of bus departures (pairs) - working day - maximum: CB lines/all international lines

	Divjača	Koper	Sežana	Nova Gorica	Kobarid	Most na Soči	Kranjska Gora	Jesenice	Piran	Portorož	Postojna	Ljubljana
Trieste	0/0	14/13	8/4	0/0	0/0	0/0	0/0	0/0	1/1	3/2	7/4	21/5
Muggia	0/0	0/0	0/0	0/0	0/0	0/0	0/0	0/0	0/0	0/0	0/0	0/0
Udine	0/0	0/0	5/0	0/0	0/0	0/0	0/0	0/0	0/0	0/0	3/0	8/0
Gorizia	0/0	0/0	0/0	1/1	0/0	0/0	0/0	0/0	0/0	0/0	1/1	3/1
Ronchi dei Legionari	0/0	0/0	0/0	0/0	0/0	0/0	0/0	0/0	0/0	0/0	0/0	2/0
Monfalcone	0/0	0/0	0/0	0/0	0/0	0/0	0/0	0/0	0/0	0/0	0/0	0/0
Villa Opicina	0/0	0/0	2/2	0/0	0/0	0/0	0/0	0/0	0/0	0/0	0/0	0/0
Tarvisio	0/0	0/0	0/0	0/0	2/2	2/2	2/2	0/0	0/0	0/0	0/0	1/1
Cividale del Friuli	0/0	0/0	0/0	0/0	0/0	0/0	0/0	0/0	0/0	0/0	0/0	0/0
Grado	0/0	0/0	0/0	0/0	0/0	0/0	0/0	0/0	0/0	0/0	0/0	0/0
Lignano	0/0	0/0	0/0	0/0	0/0	0/0	0/0	0/0	0/0	0/0	0/0	0/0
Venice	0/0	6/5	6/3	4/4	0/0	0/0	0/0	0/0	0/0	3/2	6/4	36/12
Pordenone	0/0	0/0	1/0	0/0	0/0	0/0	0/0	0/0	0/0	0/0	1/0	1/0
Portogruaro	0/0	0/0	0/0	0/0	0/0	0/0	0/0	0/0	0/0	0/0	0/0	0/0
San Donà di Piave	0/0	0/0	0/0	0/0	0/0	0/0	0/0	0/0	0/0	0/0	0/0	2/0

Table 12: CB centres connectivity- number of bus departures (pairs) - Sunday: CB lines/all international lines

	Divjača	Koper	Sežana	Nova Gorica	Kobarid	Most na Soči	Kranjska Gora	Jesenice	Piran	Portorož	Postojna	Ljubljana
Trieste	0/0	5/4	6/2	0/0	0/0	0/0	0/0	0/0	0/0	3/2	6/3	20/4
Muggia	0/0	0/0	0/0	0/0	0/0	0/0	0/0	0/0	0/0	0/0	0/0	0/0
Udine	0/0	0/0	4/0	0/0	0/0	0/0	0/0	0/0	0/0	0/0	4/0	8/0
Gorizia	0/0	0/0	0/0	5/5	0/0	0/0	0/0	0/0	0/0	0/0	1/1	3/1
Ronchi dei Legionari	0/0	0/0	0/0	0/0	0/0	0/0	0/0	0/0	0/0	0/0	0/0	2/0
Monfalcone	0/0	0/0	0/0	0/0	0/0	0/0	0/0	0/0	0/0	0/0	0/0	0/0
Villa Opicina	0/0	0/0	0/0	0/0	0/0	0/0	0/0	0/0	0/0	0/0	0/0	0/0
Tarvisio	0/0	0/0	0/0	0/0	2/2	2/2	2/2	0/0	0/0	0/0	0/0	0/0
Cividale del Friuli	0/0	0/0	0/0	0/0	0/0	0/0	0/0	0/0	0/0	0/0	0/0	0/0
Grado	0/0	0/0	0/0	0/0	0/0	0/0	0/0	0/0	0/0	0/0	0/0	0/0
Lignano	0/0	0/0	0/0	0/0	0/0	0/0	0/0	0/0	0/0	0/0	0/0	0/0
Venice	0/0	6/5	6/3	4/4	0/0	0/0	0/0	0/0	0/0	3/2	5/3	35/11
Pordenone	0/0	0/0	1/0	0/0	0/0	0/0	0/0	0/0	0/0	0/0	1/0	1/0
Portogruaro	0/0	0/0	0/0	0/0	0/0	0/0	0/0	0/0	0/0	0/0	0/0	0/0
San Donà di Piave	0/0	0/0	0/0	0/0	0/0	0/0	0/0	0/0	0/0	0/0	0/0	2/0

Table 13: CB and hinterland centres connectivity - time of transport - car/public transport (bus)

	Divaç a	Koper	Sežana	Nova Gorica	Kobarid	Most na Soči	Kranjska Gora	Jesenic e	Piran	Portorož	Postojna	Ljubljana
Trieste		0:25/0:35	0:23/0:26						0:41/1:25	0:38/1:19	0:45/0:53	1:16/1:40
Muggia												
Udine			0:57/1:30								1:20/2:10	1:51/2:55
Gorizia				0:10/0:10							0:45/1:10	1:16/1:57
Ronchi dei Legionari												1:25/2:37
Monfalcone												
Villa Opicina			0:10/0:08									
Tarvisio					1:01/1:28	1:19/2:07	0:22/0:31					1:23/2:44
Cividale del Friuli												
Grado												
Lignano												
Venice		1:52/2:27	1:36/2:44	1:21/1:39						2:06/3:05	2:08/:3:17	2:28/3:30
Pordenone			1:21/2:59								1:43/3:34	2:13/4:24
Portogruaro												
San Donà di Piave												2:27/3:50

Table 13 provides an analysis of CB bus transport time, which is one of the main factors of public transport attraction as declared by the stakeholders in a research of their priorities, which is presented below.

Transport time analysis brings comparison of transport times for bus transport among CB and hinterland centres (obtained from the official timetables) in comparison personal car transport as available by Google Maps route planner.

Bus transport can be extremely efficient on shorter distances as identified for:

- Trieste - Sežana,
 - Villa Opicina - Sežana,
 - Tarvisio - Kranjska Gora,
 - Trieste - Postojna and
 - Gorizia/Nova Gorica city transport,
- where car transport is faster only in a range of some minutes¹⁵.

Car transport is especially efficient on longer distances, mainly also on account of the intermediate stops that serve to the passengers along the line. The transport time can in certain cases be almost doubled in favour of the car, as in examples of Tarvisio-Ljubljana or Pordenone-Ljubljana lines.

The following figures (Figure 23, Figure 24 and Figure 25) show bus transport time analysis.

Figure 23: Time connectivity between ITA-SLO CB centres by car/bus transport

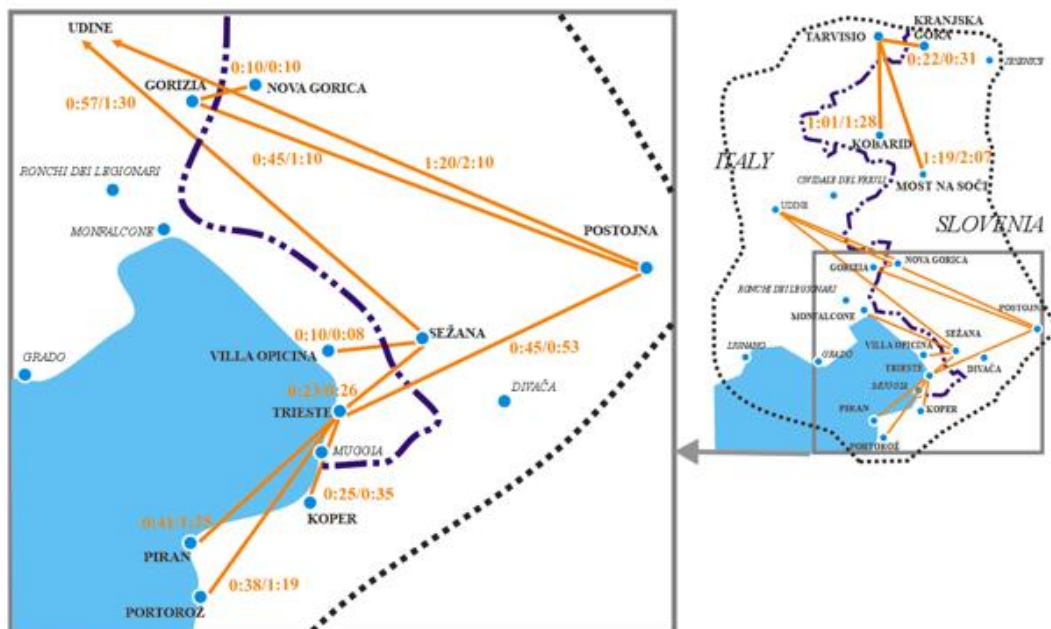

¹⁵ Small time difference can be consumed for car-parking manoeuvring on one hand and for the initial waiting time at the bus stop/station on the other. Transfer time to the bus stop/station (walk, car ...) has not been taken into account either.

Figure 24: Time connectivity of Italian hinterland centres to CB and hinterland centres in Slovenia by car/bus transport

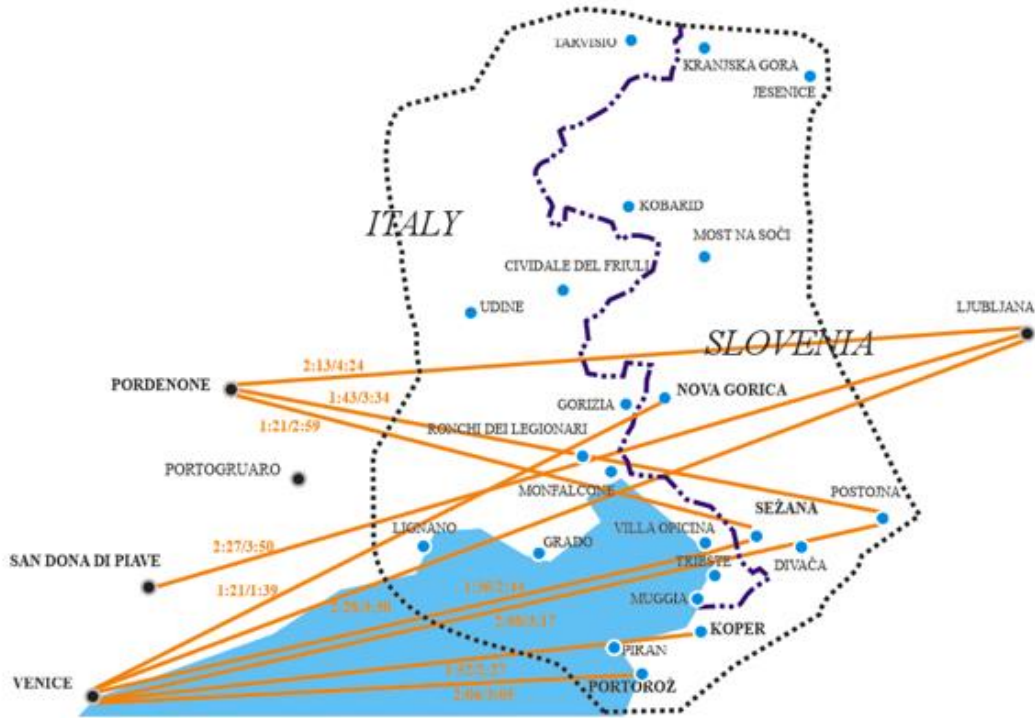
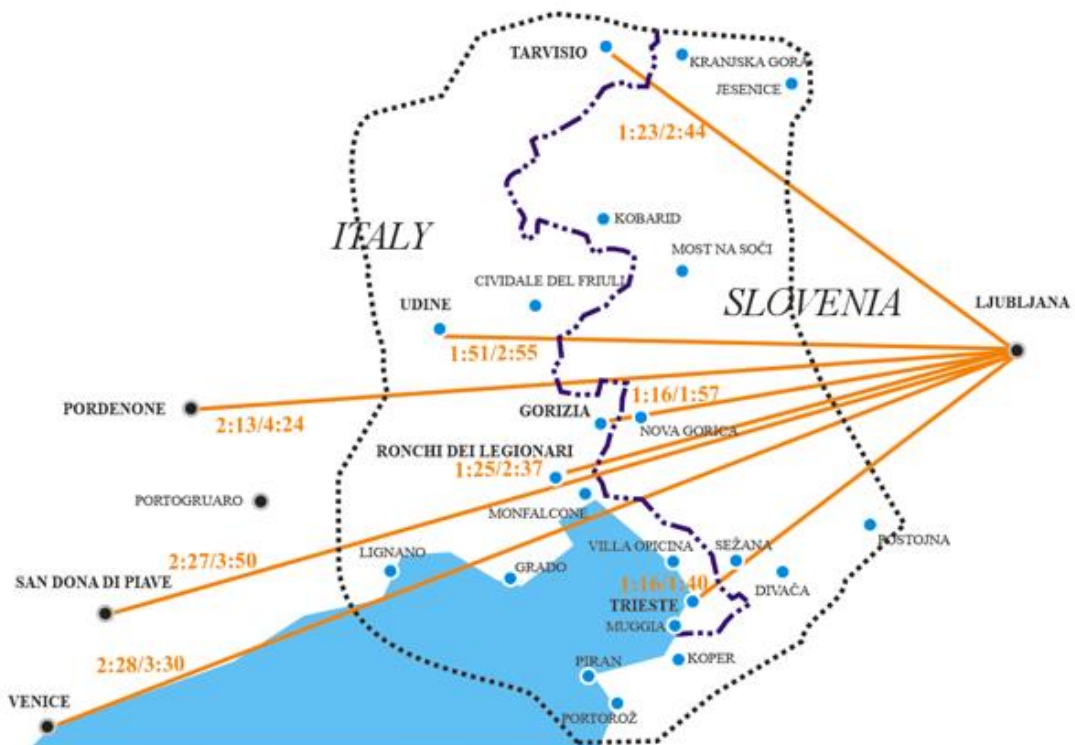

Figure 25: Time connectivity of Ljubljana to CB and hinterland centres in Italy by car/bus transport



3.3.1.3 Maritime transport

Maritime transport is still characterized by significant potential improvements for CB interregional commuting. Maritime transport is mainly related to the tourist and leisure activities as it is attractive for scenic journeys and it connects places at the coast of tourist interest. For commuting purposes, this type of transport needs better frequency of departures and good intermodal connection to other last mile or other further transport legs. Maritime transport can be a convenient transport especially during the summer queues on highways and other roads, blocked by the excessive road transport.

Currently only 1 seasonal ferry line is connecting Italian and Slovenian coastal CB centres, Trieste and Piran.

This cross-border maritime service was activated in 2014 thanks to the EASEAWAY Project funded under the IPA Adriatic Programme 2007-2013 and further extended thanks to the Italy Croatia 2014-2020 MOSES project. In particular a passenger service was tested in terms of connection between Trieste, Slovenia (Piran) and Istria Region (Rovinj, Pula, recently Mali Lošinj). After the testing phase, Friuli Venezia Giulia Region decided to finance and extend this service during summer period line with own resources on yearly basis. Another ferry line is operated by Venezia Lines, on the route between Piran and Venice (every Saturday).

Figure 26: Maritime CB lines

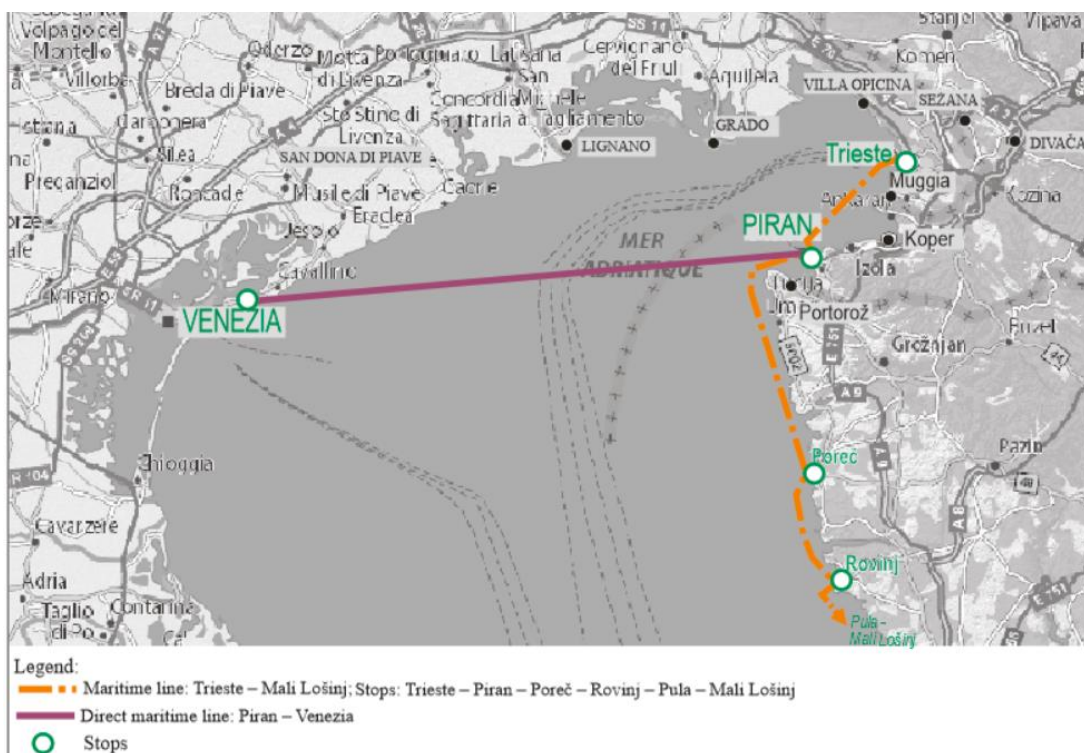

An overview of maritime lines is given in [Error! Not a valid bookmark self-reference..](#)

Table 14: Regular maritime lines between Italy and Slovenia

Operator	Maritime line	Stops	Country origin	Country destination	Regime YEAR	Regime WEEK
Liberty Lines	Trieste - Mali Lošinj	Trieste - Piran - Poreč - Rovinj - Pula - Mali Lošinj	Italy	Croatia	summer	six days per week
Venezia Lines	Piran - Venice	Piran - Venice	Slovenia	Italy	summer	Saturdays

3.3.1.4 Intermodal transport

Cross border intermodal transport analysis is focused on:

- identification of different transport modes of CB transport that connect CB and hinterland centres over the country border as well as
- identification of missing infrastructure railway infrastructure links or railway lines in order to connect the locations from the same gravitational area on opposite sides of the state border.

Table 11 shows the available transport modes linking the CB and hinterland centres, either train, bus or maritime. Wherever more than one CB line mode is available there is a possibility for intermodal connection or for improvement frequency of connections. Local modalities for last mile transport were already considered above, chapter **Error! Reference source not found.** (**Error! Reference source not found.**) and **Error! Reference source not found.** (**Error! Reference source not found.**).

To set-up an intermodal line a thorough investigation of locations of intermodal transfer points as well as a solid contractual or legal framework must be provided.

Table 15: CB and hinterland centres connectivity - transport modes: T - train, B - bus, M - maritime

	Divača	Koper	Sežana	Nova Gorica	Kobarid	Most na Soči	Kranjska Gora	Jesenice	Piran	Portorož	Postojna	Ljubljana
Trieste	T	B	T,B						B,M	B	T,B	T,B
Muggia												
Udine			T,B								T,B	T,B
Gorizia				B							B	B
Ronchi dei Legionari												B
Monfalcone			B									
Villa Opicina	T		T,B								T	T
Tarvisio							B					
Cividale del Friuli												
Grado												
Lignano												
Venice		B	B	B					M	B	B	B
Pordenone			B								B	B
Portogruaro			B									
San Donà di Piave												B

The missing railway infrastructure links between the gravitational points (pairs of points on each side of the state border) were identified by identification of the points and the nearest railway network connections to be connected by bus or maritime lines in order to connect the two local or regional railway networks and CB across the borders by bus. The existing cross-border bus transport service is taken into account in order to assess the availability of network connections.

The following pairs of gravitational cross-border points are taken into analysis:

- Tarvisio (IT) - Kranjska Gora (SI): Jesenice (SI)
- Cividale del Friuli (IT) - Kobarid (SI): Most na Soči (SI)
- Gorizia (IT) - Nova Gorica (SI)
- Villa Opicina (IT) & Trieste (IT) - Sežana (SI)
- Trieste (IT) - Koper (SI)

Connection of the railway networks from each side of the state border is presented in the following figures by showing:

- regional (local) railway connections in the CB area and to the hinterland as well as
- the existing and optional cross-border bus and maritime lines (if the bus line exists it is presented in number of daily connections - international/CB lines).

Figure 27: CB railway network connection: Tarvisio (IT) and Kranjska Gora (SI)

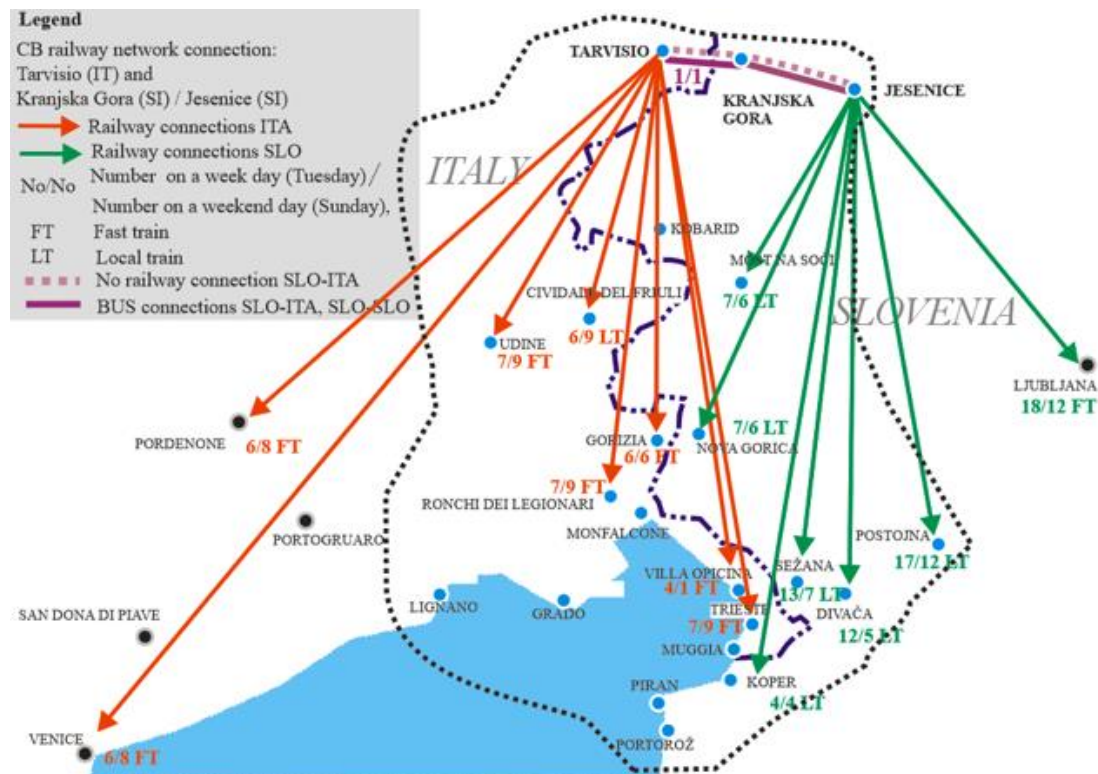

Figure 28: CB railway network connection: Cividale del Friuli (IT) and Kobarid (SI)

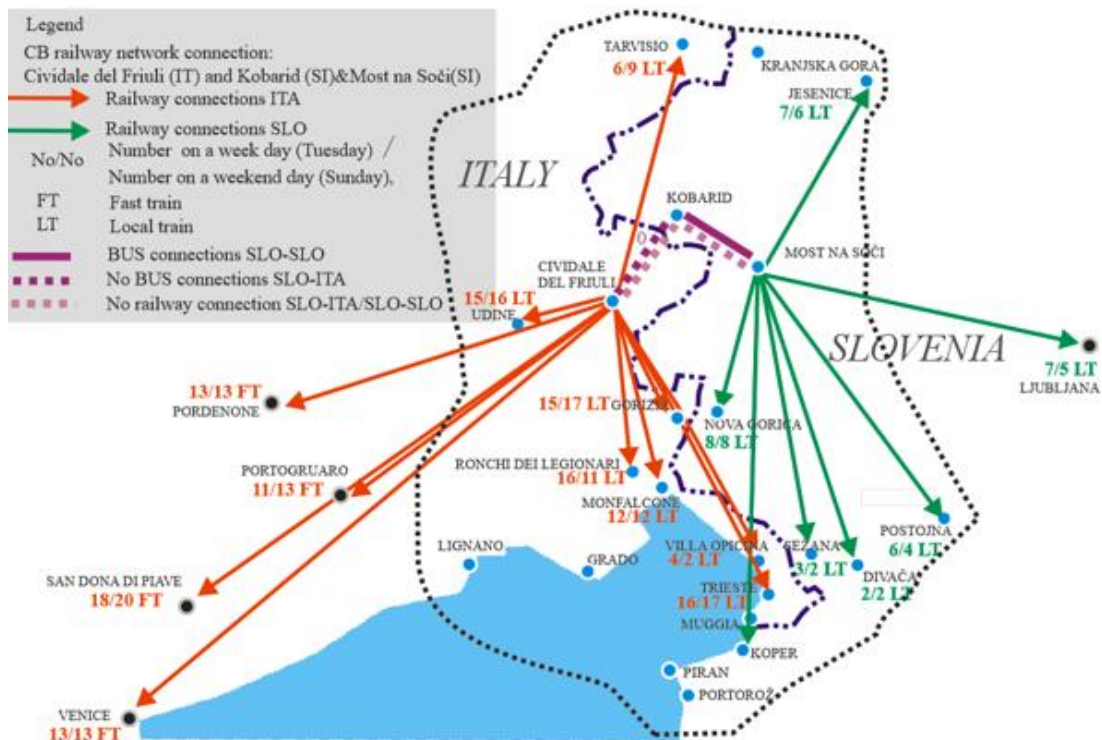

Figure 29: CB railway network connection: Gorizia (IT) and Nova Gorica (SI)

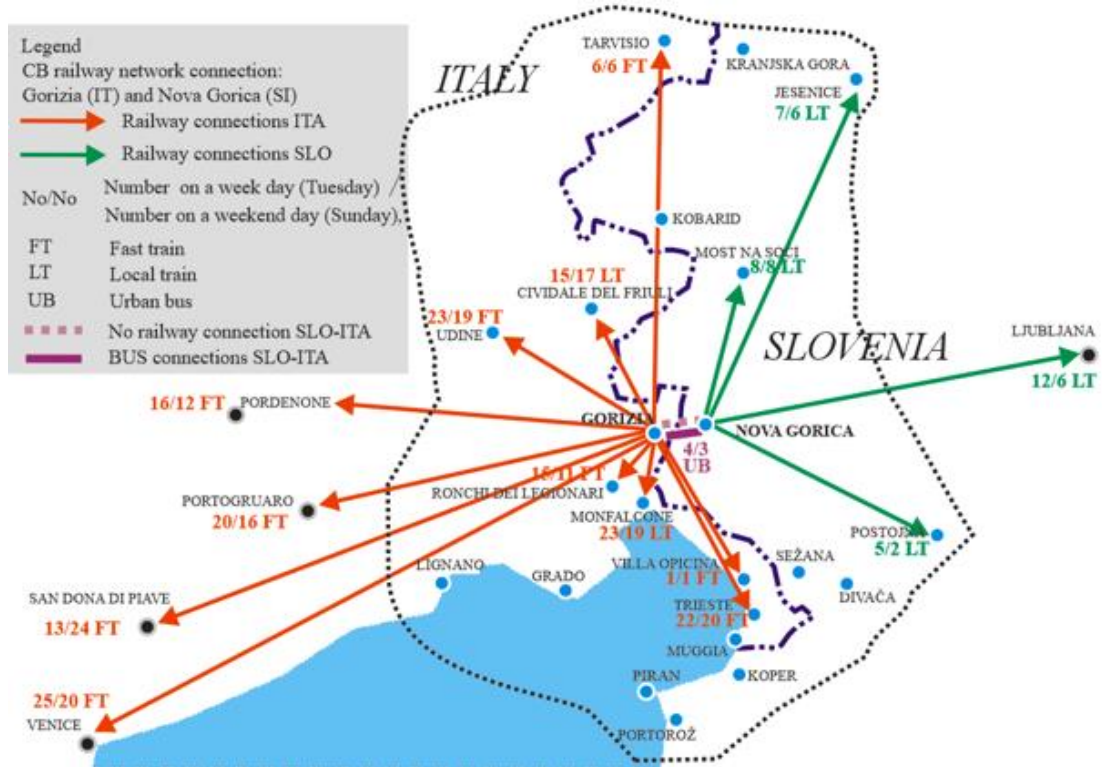

Figure 30: CB railway network connection: Villa Opicina (IT) & Trieste (IT) and Sežana (SI)

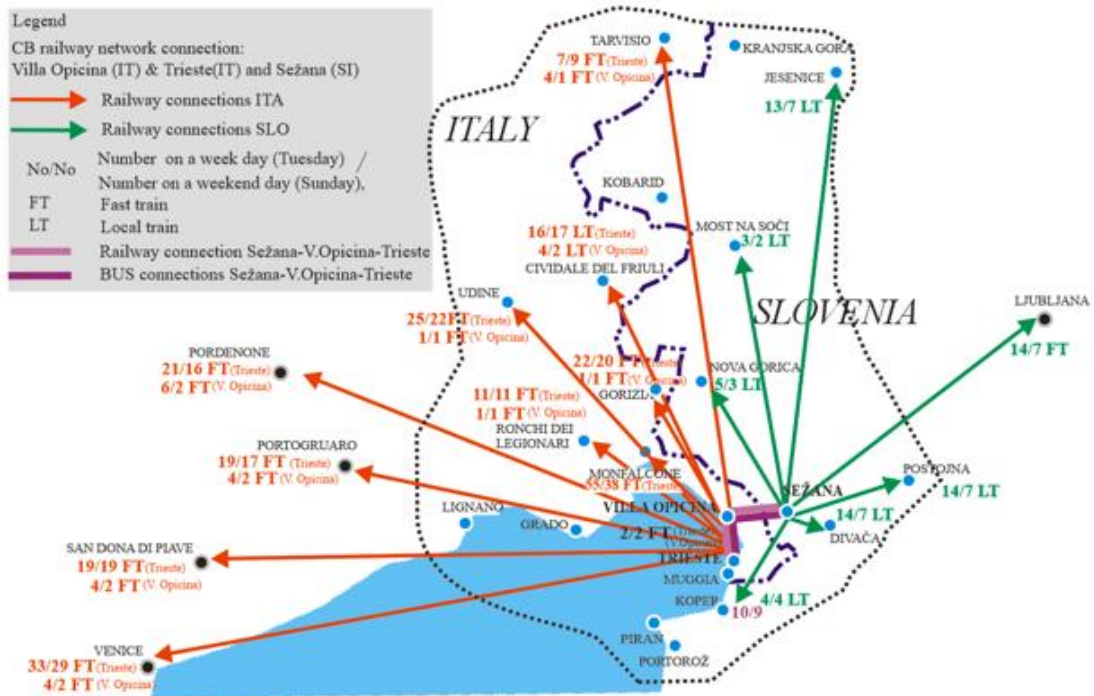
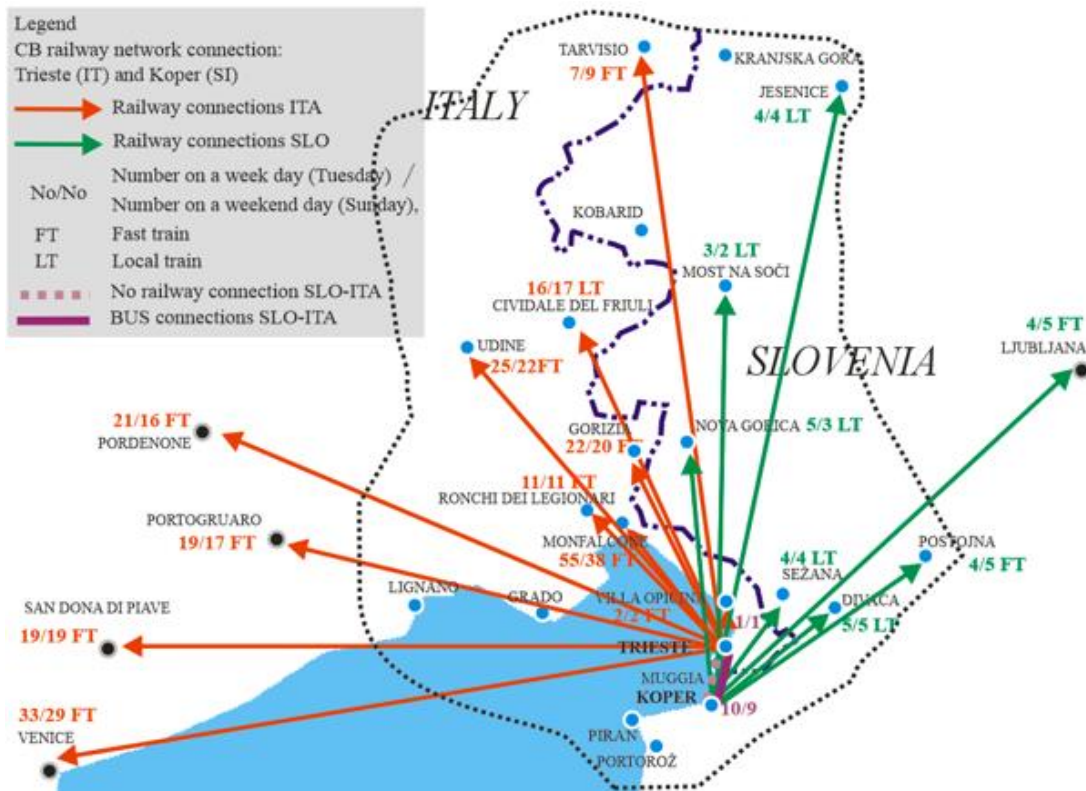

Figure 31: CB railway network connection: Trieste (IT) and Koper (SI)



3.3.1.5 Hinterland connections

The scarcity of direct public transport connections between Slovenia and Italy, especially in railway transport, generally reduces mobility options for population in CB area and hinterland. Above all a fast rail link connecting the airport of Ronchi dei Legionari, Venice and Ljubljana, passing through the major urban areas, which is connecting the urban centres, is missing.

Cross-border connection of the Veneto region hinterland centres of Venice and San Donà di Piave as well as Pordenone in FVG Region on one hand and Ljubljana in Slovenia on the other hand, are served by the long-distance public passenger service, particularly railways. Currently no direct service is available among many hinterland centres across the border and especially between Ljubljana and Venice as the most outstanding points. Therefore, a consideration should be made to extend the existing cross-border lines as a backbone and linking other points of interests on either side to the intermediate or transfer stops.

The opportunity for new cross-border lines makes the new concession contract awarded to TPL FVG regional transport operator giving the operator flexibility to activate and operate additional cross-border services upon request or self-motivation.

3.4 INTEGRATION OF PUBLIC PASSENGER TRANSPORT

3.4.1 Management of integration

Integration of public passenger transport on a local level is managed by the regional authorities in Italy (FVG and Veneto) and by the state authority in Slovenia (Ministry of Infrastructure). Cross-border integration is currently left to the initiative of local transport management and transport operators but with intention of higher level structures (FVG) to foster the public transport integration process.

In June 2020 a single operator of all local public transport services (urban/extra urban bus, tram, maritime) was selected to promote harmonisation of **tariffs** as well as **multi-operator** and **multimodal timetables** and **ticketing** systems in integration of local but also cross-border passenger transport¹⁶. Since the inception of the operation of “TPL FVG Scarl”, a single transport operator in the entire FVG Region, a new unified infomobility system has already been put in operation. Additionally, local public transport tickets in all cities in the region, operated by “TPL FVG Scarl” have been unified (Udine, Pordenone, Trieste, Gorizia, etc.).

The former activity of the FVG to promote and approve homogeneous tariffs for separate transport operators and transport modes, has now been assumed by the new single regional transport operator.

In Veneto integration process has started on a regional level. It is being supported through on a UNICA VENETO, a CALYPSO standard smart card that is capable to store tickets provided by various regional operators. The tickets can also be stored in other dedicated (e.g. tourist cards etc.) cards or mobile apps (DaAaB). There are also some multi-operator integration of services, like Treviso - Venice, ACTIVO - transport system of eastern Venice area, train services provided by Trenitalia and Sistemi Territoriali, linking Venice, etc.

In 2016 Slovenian Ministry of Infrastructure has rolled out a state-wide integrated public passenger transport for the whole country, called IJPP (Integrated Public Passenger Transport). The Ministry also embodies a national Integrated Public Passenger Transport Authority (IPPTA).

At the inception only student passes were available for complete inter-urban transport and some major urban transport systems in Slovenia. In 2019 the system has gradually spread to other types of tickets and passenger groups. The Slovenian integrated ticket features **multi-operator**, **multimodal**, **multi-level** (urban and interurban transport systems). Integration is based on a **uniform tariff scheme** and a **uniform ticketing system** using smart card technology providing electronic ticket recognition, a unified on-line ticket sale, management and verification system.

¹⁶ Regional plan of public local transport: Piano Regionale del Trasporto Pubblico Locale - PRTPL

The integrated smart card is a multi-application smart used for storing integrated tickets as well as other products of the card issuer (e.g. operator). Integrated ticket smart card application has been standardized at the IPPTA.

A uniform ticketing system also includes a unified passenger **infomobility system** and back-office information and clearing system. **Timetables** are still in process of harmonisation. Slovenia uses MIFARE DESFire smartcard standard.

The IJPP integrated infomobility system provides pre-trip information, i.e. static timetables (GTFS), on all extra-urban and regional transport lines in Slovenia (both bus and train) in the network covering 5.244 bus stops and 262 railway stops. The infomobility system also provides information on valid lines for the selected trip from A to B and other information.

Figure 32: <http://jpp.si/web/guest/domaca-stran> - trip planner by IPPTA

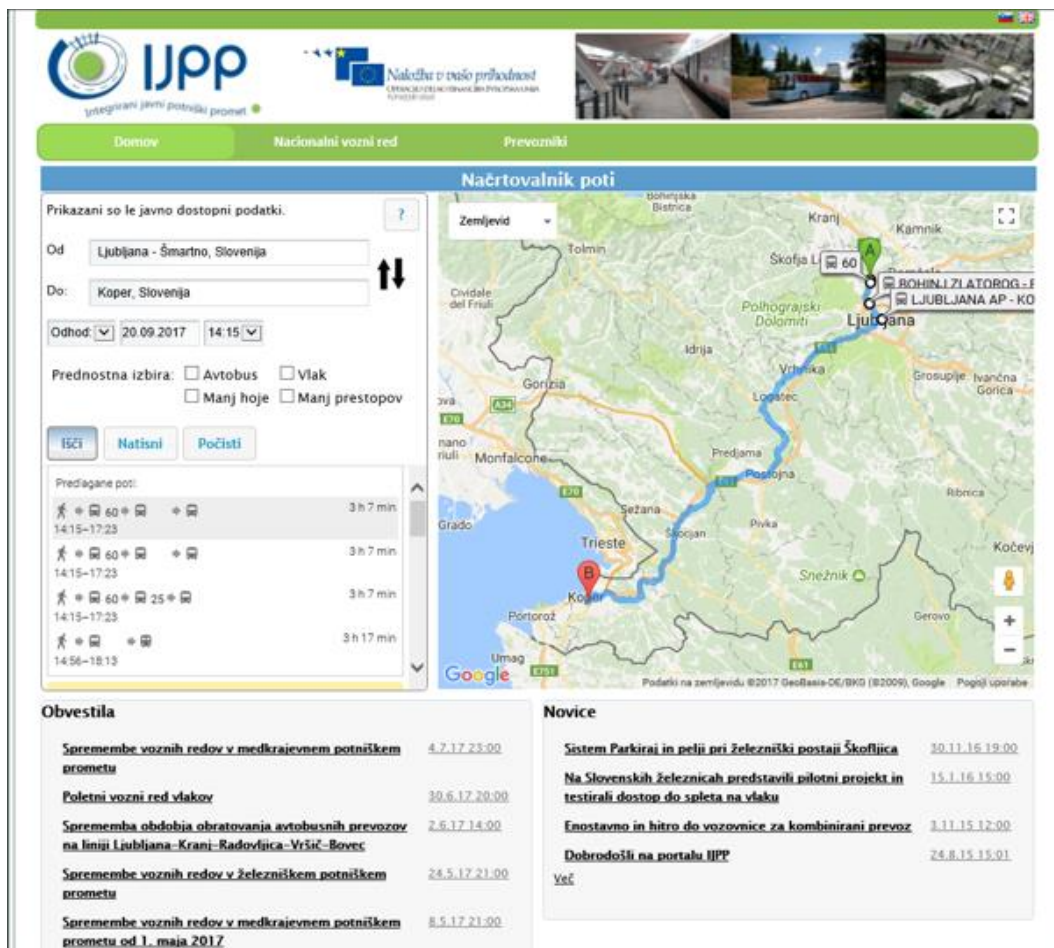

The screenshot shows the IJPP website interface. At the top, there are logos for IJPP and the European Union. Below the logos, there are navigation tabs: 'Domov', 'Nacionalni vozni red', and 'Prevozniki'. The main section is titled 'Načrtovalnik poti' (Route Planner). It includes a search form with fields for 'Od' (Ljubljana - Šmartno, Slovenija) and 'Do' (Koper, Slovenija), and a date/time selector set to '20.09.2017 14:15'. There are checkboxes for 'Avtobus', 'Vlak', 'Manj hoje', and 'Manj prestopov'. Below the search form, there are buttons for 'Išči', 'Natisni', and 'Počisti'. A list of suggested routes is shown, each with a travel time of 3h 7 min or 3h 17 min. To the right of the search form is a map showing the route from Ljubljana to Koper. Below the map, there are two sections: 'Obvestila' (News) and 'Novice' (News). The 'Obvestila' section contains several news items with dates, such as 'Spremembe voznih redov v medkrajevem potniškem prometu' dated 4.7.17.23:00. The 'Novice' section contains news items with dates, such as 'Sistem Parkiraj in pelji pri železniški postaji Škofljica' dated 30.11.16.19:00.

Source: <http://jpp.si/web/guest/domaca-stran>

3.4.2 Integrated lines

Integration of public passenger services has already started both with local as well as cross-border services.

3.4.2.1 Local integration

Integration of local passenger services in Italy and Slovenia is presented in **Error! Not a valid bookmark self-reference..**

Table 16: Integration of local passenger services

Line	Operators	Harmonisation	Country	Comment
Lignano (bus) - sea - Marano (bus)	TPL FVG	timetables	Italy	one operator, intermodal (urban/extra urban bus, maritime)
Udine - Gemona - Tarvisio	Trenitalia TPL FVG	timetables	Italy	harmonised parallel regional bus and train services
urban transport in Grado, Lignano, Udine, Pordenone and Gorizia; Udine - Cividale train	TPL FVG, FUC	ticket medium ("FVG CARD") tariff (free), revenue clearing	Italy	48h, 72h or 7 days pass, accepted by all the operators - the transport systems are not combined http://www.turismofvg.it/en/FVG-Card
regional bus/train, local bus service - country wide	all regional operators, local bus operators (Ljubljana, Maribor, Murska Sobota)	tariff ticketing timetable infomobility intermodality	Slovenia	complete intermodal integration of all regional public services; only selected local bus systems are included and only valid for students

3.4.2.2 Cross-border integration

Integration of cross-border passenger services between Slovenia and Italy is scarce but already exists as shown in the **Error! Not a valid bookmark self-reference..** A combined ticket between Ljubljana and Trieste also connect cross-border area to the Slovenian hinterland, namely to the Slovenian capital of Ljubljana.

Table 17: Integration of cross border services

Line	Transport scope	Operators	Harmonisation	Observation
Gorizia (IT) - Nova Gorica (SI)	urban bus	TPL FVG (IT) AVRIGO (SI)	timetable	separated tickets, tariffs infomobility, no intermodality; each operator operates a complete route, separate infomobility issues

Ljubljana ¹⁷ (train) - Villa Opicina (bus) Trieste	cross-border train urban bus	Slovenske železnice (SI) TPL FVG (IT)	timetable tariff ticketing (mobile app, print@home)	integrated ticket of cross-border train service and urban bus service
--	------------------------------------	---	---	--

3.4.3 Issues of cross-border integration

Currently, there is still room for improvement various aspects of public transport integration in FVG region, nevertheless FVG region has succeeded to assign a single operator of all public transport systems in the region, which in turn promotes integration and interoperability of the sub-systems, thus contributing in highlighting the importance of such issue. At the level of infomobility systems, private initiatives exist providing integrated travel information extending over the FVG region on a single portal, also serving to integration and optimisation of the public transport systems.

After a very successful rollout in 2016 of the Slovenian national extra-urban and urban multimodal and multi-operator smart card based integrated public passenger transport system many upgrades have been implemented. Still many questions need to be closed: nomination and operation of professional IPPTA, extension of smart card technology to AZTEC 2D barcode, service commission oriented revenue sharing model, better harmonisation of timetables, inclusion to the system all available urban transport systems, flexible pricing and loyalty schemes, personal transport accounts, upgrade of GIS infomobility support, enforcement of the technology standard to prevent monopoly of operation and maintenance of the system, cross-border integrations, etc.

Integration and intermodality of cross-border transport is practically not existing. Apart from the pilot initiative developed in CONNECT2CE project (EU CE Programme), no systematic cross-border ticketing system is currently available, no tariff harmonisation, no intermodality and no infomobility integration exists. Each transport provider/carrier usually provides its own web page and optionally a call centre for providing information on routes, timetables, ticket purchase and reservations but no on-trip information. Such fragmentation makes passengers struggle to only get the information on the available transport offer let alone passenger friendly travel experience and flexibility.

Very important harmonisation of municipal transport has taken place in the CB township of Gorizia and Nova Gorica providing joint operation of CB municipal line and timetable harmonisation, but the only real example of integration was a CONNECT2CE project pilot action, connecting Ljubljana to Villa Opicina by train and Villa Opicina to Trieste centre by bus with all substantial integration elements. Integration of ticketing systems, tariff harmonisation, common infomobility portal, intermodality, multi-operation, ticket revenue sharing could serve as a model for other initiatives or better systematic approach to bring forward better efficiency of CB public transport.

¹⁷ Service closed since 30/4/2020.

Following the successful Gorizia - Nova Gorica case there is a tendency of local communities and transport operators to extend the existing urban and extra-urban bus lines across the border from both sides of the border, by duly raising the frequency of departures and harmonising timetables of different bus operators. Attention should be paid to find the real bottlenecks (identify cross-border locations that need additional connections and connection is technically feasible), to involve additional relevant decision-makers (e.g. Ministry of Infrastructure for extra-urban bus transport), different bus transport status (urban bus on one side of the border, extra-urban on another), involvement of the traversed municipalities (e.g. Koper and Trieste are not neighbouring municipalities), technical barriers (e.g. city bus cannot drive on fast roads), technological aspects (e.g. different smart card standards¹⁸) etc.

¹⁸ CALYPSO smartcard standard used in Veneto region has a tendency to spread from Veneto to extra-regional transport lines. As in Slovenia the MIFARE DESFire smartcard standard is used, this could strongly impact progression of CB ticketing.

4 STRATEGIC PRIORITIES FOR IMPROVEMENT OF PUBLIC TRANSPORT ACCESSIBILITY

4.1 REVIEW OF INSTITUTIONAL PRIORITIES

Review of institutional priorities is focussed on:

- EU legislation on cross-border passenger transport and
- cross-border cooperation on mobility (EU legislation, bilateral agreements, regional initiatives).

4.1.1 EU legislation on operation of cross-border passenger transport

EU legislation does not consider cross-border public passenger transport a special service of public passenger transport; therefore, the **rules on international regular passenger transport** are directly applicable.

Implementation of the regular international carriage of passengers by coach and bus¹⁹ is subjected to the possession of a Community licence; any road passenger transport operator with the valid licence has free access to the whole international EU road transport market. In each country, where the stops are planned, an authorisation of regular international route is required by a competent authority. Any carrier holding a Community licence can also operate cabotage operations for the regular services, in the course of a regular international service.

Similarly to regular road international passenger transport, EU legislation²⁰ gives rail operators with a licence and the required safety certificates the ability to run railway passenger transport in and between other EU countries. The international trains are also allowed to perform cabotage and can pick up and set down passengers at stations located in other Member States. If the economic equilibrium of a public service contract could be compromised, Member States can limit the right of access for international passenger transport on routes covered by public service contracts and can introduce charging of a levy on international rail passenger services to compensate the cost incurred through public service contracts. The international railway lines are determined by a complex negotiation procedure of infrastructure capacity allocation between several railway networks in the Union, therefore the allocations are agreed at least one year before operation on regular railway international conference meetings between infrastructure managers.

In the maritime transport sector, EU regulation²¹ and international conventions on maritime transport (e.g. SOLAS), also allows free provision of international passenger services between any

¹⁹ Regulation (EC) No 1073/2009.

²⁰ Directive 2012/34/EU.

²¹ Regulation (EEC) 4055/86.

ports of a Member State and any port or offshore installation of another Member State and ensures that those services are offered at good prices.

According to EU legislation international road, railway and maritime passenger transport is carried out as a commercial service. Info-mobility services (information for passengers) are responsibility of transport operators and there is no obligation for integration between different operators of same mode of transport services, except in international railway passenger transport where COTIF²² define uniform rules for the international ticket, nor between different modes.

4.1.2 Cross-border cooperation for sustainable mobility

4.1.2.1 EU legislative framework

EU is developing cross-border cooperation through European regional policy, notably through the European Regional Development Fund - ERDF²³ and INTERREG²⁴ programmes which have become the key engine of the cross-border institutionalization and an inevitable instrument for cross-border town and country planning. The part of INTERREG programmes on cross-border cooperation more specifically focuses on cooperation between adjacent border areas with the NUTS 3 rank. Financial support for INTERREG cooperation projects is provided within an INTERREG programme and other means to help border cities or/and regions to work together on common projects and share good practice.

Cross-border cooperation has been empowered by the creation of another devoted legal instrument: **European Grouping for Territorial Cooperation - EGTC²⁵** as a tool, designed to overcome the difficulties, encountered in implementing and managing projects in the field of territorial cooperation, which are subject to different legislation and procedures, and to facilitate the implementation of common tasks. The objective of EGTC is facilitation and promotion of territorial cooperation between the members of EGTC at transnational or transregional level. EGTC is based on the founding agreement of its members and the statute, which defines the organizational and functional rules. It has legal personality, and is aimed at implementing programs, projects or specific actions referred to territorial cooperation. The members of an EGTC can be national, regional or local authorities of member States, public undertakings, operators of service of general economic interest operators and associations consisting of bodies belonging to one or more of these categories. By joining the EGTC, the participants are legally organized in an independent cross-border body with a legal personality and they can directly interact with European institutions and third parties. EGTCs can facilitate

²² COTIF - Convention concerning International Carriage by Rail (COTIF). The agreement applies in Europe, the Maghreb and the Middle East EU acceded to the Organisation for International Transport by Rail (OTIF) on 1 July 2011.

²³ Regulation (EU) No 1301/2013.

²⁴ Regulation (EU) No 1299/2013.

²⁵ Regulation (EU) No 1082/2006.

both transport infrastructure and service development beyond national borders, contributing to improved connectivity and mobility at different territorial levels²⁶.

At the Italy-Slovenia border, only one EGTC has been established; EGTC GO. It has been set-up in September 2011 by the three cities: Gorizia, Nova Gorizia and Šempeter-Vrtojba²⁷. The main goal of the EGTC GO is strategic coordination of policies for the area, including transport and logistics. The transport strategy plan of the EGTC GO casts focus on Gorizia-Nova Gorica-Šempeter Vrtojba railway line, however EGTC is very interested also in optimization of existing solutions of cross-border public passenger transport in the area between cities Nova Gorica (SI) and Gorizia (IT). Despite not involving Slovenia, also “EGTC Euregio senza confini” is very active in cross-border initiatives and projects between Italy and Slovenia, also being a partner in a CROSSMOBY IT-SI strategic mobility project (<https://euregio-senzaconfini.eu/it/>).

4.1.2.2 Bilateral agreements concluded between Italian Republic and Republic of Slovenia

Slovenia and Italy have concluded a bilateral agreement on the regulation of personal transport and land and maritime transport in CB area²⁸. This agreement has had a standstill status since the day of Slovenia's accession to the EU, which means that it has not been revoked and is only partially applied in practice. The agreement defines cross-border areas and regulates the conditions and procedures for cross-border maritime and land transport between Slovenia and Italy (defining cross-border lines, tariff for passenger transport, ticket sales, regular bus traffic, issuing concessions, etc.). The standstill status prevents it from using in regulation of cross-border transport between Slovenia and Italy. The Joint Commission, consisting of representatives of both countries, which is envisaged by the bilateral agreement as a permanent body to observe mutual issues in the field of transport, is still active, but meets only occasionally. It met last time on 16 May 2019 in Rome at the initiative of the Slovenian Ministry of infrastructure. According to the position of the Slovenian Ministry of Infrastructure, this agreement cannot be reactivated and a new bilateral agreement should be concluded between Slovenia and Italy to regulate the issues and problems of the cross-border agreement.

²⁶ Several cross-border regional development EGTCs with a multi-sectoral approach include transport related activities and some EGTCs have a specific transport focus.

²⁷ EGTC GO - Territorio dei comuni: Comune di Gorizia (I), Mestna Občina Nova Gorica (SLO) and Občina Šempeter-Vrtojba (SLO).

²⁸ Decree on the ratification of the agreement between the Socialist Federal Republic of Yugoslavia and the Republic of Italy on the regulation of personal transport and land and maritime transport between border areas (Official Gazette of the Republic of Slovenia, No. SFRJ-MP, No. 10-73 / 1986 of 3 October 1986)

In addition to the above-mentioned agreement, two bilateral agreements have been concluded between Slovenia and Italy, which regulate the provision of railway transport²⁹ and the border railway service³⁰ across the state border.

4.1.2.3 Cross-border passenger transport strategies and projects

For the implementation of the EU INTERREG programme, cross-border strategies and joint projects have been adopted as a basis for ITA-SLO CB area development. The Italian border region Friuli Venezia Giulia, which is and Italian partner for regulation of CB passenger transport, has also adopted several strategic documents for the development of CB transport. Slovenian partner, responsible for CB passenger transport regulation is the state (Ministry of Infrastructure), where border municipalities in Slovenia may autonomously only enter the urban CB transport development projects. The adopted Slovenian national strategies don't specifically address development of CB passenger transport. At the municipal level a special strategic framework was formed, on the other hand, within the Economic Grouping for Territorial Cooperation (EGTC GO)³¹, in terms of transport focussed on development of CB railway connection between Gorizia and Nova Gorica.

Within the EU INTERREG and other EU programmes, many international projects have been implemented, which deal with the cross-border passenger services between Italy and Slovenia. These projects resulted in formulation of several recommendations, strategic orientations and measures were for improvement of supply and use of public transport services and elimination of administrative barriers.

The following explains a strategic framework that addresses development of public passenger transport in the cross-border area between Italy and Slovenia.

INTERREG cross-border cooperation programme Italy-Slovenia 2021-2027

New Cross-border cooperation programme Italy-Slovenia 2021-2027 is in the process of preparation. A Border Orientation Paper Italy-Slovenia has been prepared in 2019 as a basis for a constructive dialogue within the cross-border region and with the European Commission. Road connectivity measured as access to regional centres by car is within the medium range in comparison to EU averages but it is an issue in the Northern part of the Slovenian cross-border area, the Northern parts of Udine and Pordenone. The residents in this cross-border area have not adequate cross-border rail services compared to other EU border regions. The frequency of rail

²⁹ Act on Ratification of the Convention between the Government of the Republic of Slovenia and the Government of the Italian Republic on the Conduct of Railway Transport Across the State Border (BITOŽP) (Official Gazette of the Republic of Slovenia, No. 57/2000).

³⁰ Decree approving the Agreement between the Italian State Railways (FS) and the Yugoslav Railways (JŽ) on the provision of the border railway service between the Federal People's Republic of Yugoslavia and the Republic of Italy with an annex (Official Gazette of the FRY, No. 5-70 / 1961).

³¹ EGTC-GO is participated by Slovenian municipalities Nova Gorica and Šempeter-Vrtojba as well as Italian municipality of Gorizia.

connections and speed of connection is in the low range compared with other EU border regions, therefore the orientation paper propose to support investments in rail (i.e. Gorizia - Nova Gorica link) and measures to improve interoperability and procedures at border crossing through new INTERREG cross-border programme.

The orientation paper also recommends supporting the Establishment of a strong cross-border coordination mechanism with the authorities managing mainstream programmes and the development of overall cross-border strategy in coordination with existing macro-regional, national, regional or sectoral strategies. Already established EGTC-GO has a strategic focus for the development of the concerned areas and is actively involved in many cooperation projects and strategy and could serve as example for the creation of other cross-border bodies on Slovenia-Italy cross-border area.

Good cross-border policy should be based on reliable data, therefore the orientation paper recommends to identify the areas where important cross-border data on the IT-SI border is missing and support projects that would fill the gap within the INTERREG programme (e.g. in cooperation with national statistical offices, by supporting regional data portals etc.).

Regional plan of public local transport³² on the area of region of Friuli Venezia Giulia

Figure 33: Relevant ITA-SLO CB train service according to PRTPL³³

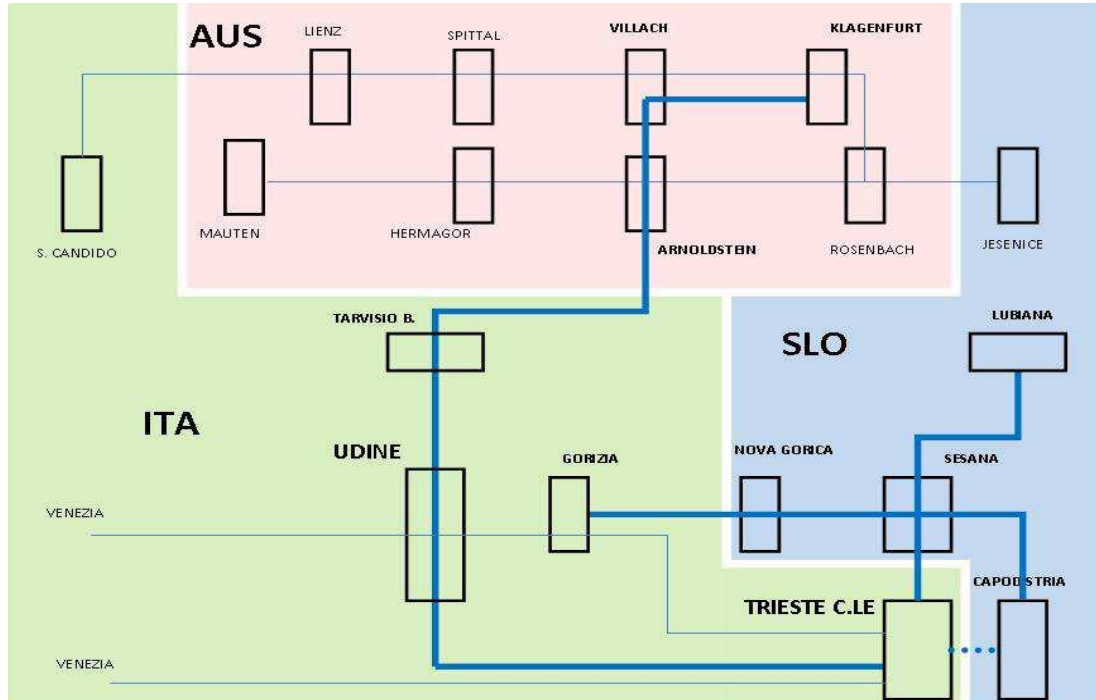

Source: Piano Regionale del Trasporto Pubblico Locale - PRTPL, 2013.

³² Piano Regionale del Trasporto Pubblico Locale - PRTPL, 2013.

³³ PRTPL includes also connection to Ljubljana, which is the destination of a CB rail service funded within an ongoing strategic project (CROSSMOBY) financed by the Programme INTERREG Italy-Slovenia.

In 2013, Friuli Venezia Giulia Region (FVG Region) has adopted a new **Regional Plan for Local Public Transport (PRTPL)** as an instrument that configures the regional and local system of passenger transport services and interchange infrastructures³⁴. PRTPL includes planning and programming of regional and interregional bus, railway and maritime passenger services and cross-border railway lines, which are in the competence of the Region FVG.

Among the main mid-term aims of PRTPL, the enhancement of cross-border service should pursue extending of existing local transport lines to achieve integration between Italian and Slovenian bus services operating near the border, as well as enhancing synergy and timetable coordination of cross-border trains. The relevant **cross-border rail connections** addressed in the PRTPL are shown in **Error! Reference source not found.**

Figure 34: Relevant cross-border bus services between Italy and Slovenia according to PRTPL

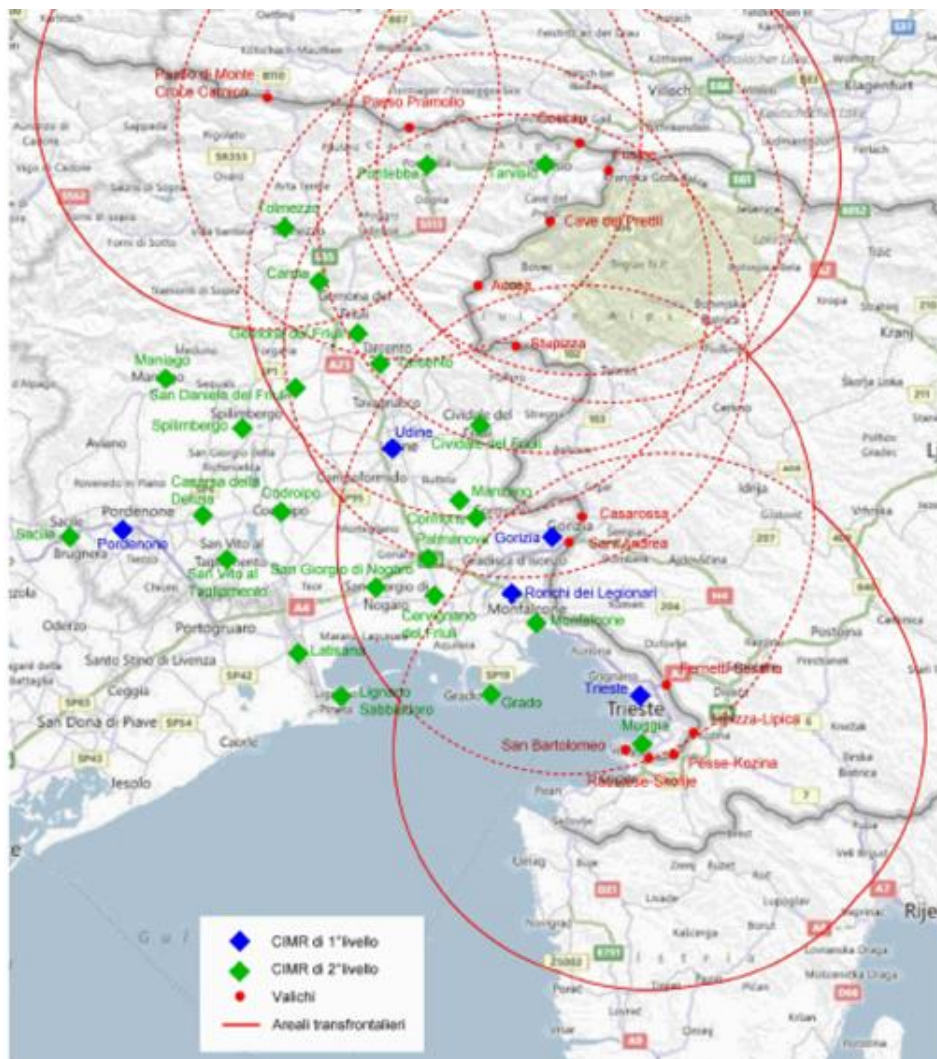

³⁴ <https://www.regione.fvg.it/rafvfg/cms/RAFGV/infrastrutture-lavori-pubblici/infrastrutture-logistica-trasporti/FOGLIA107/>

Vir: Piano Regionale del Trasporto Pubblico Locale - PRTPL, 2013.

According to PRTPL, **public bus services are qualified as cross-border**, when connecting origin and destination in territorial areas within 40 km radius centered in the bus border crossing marked as red points in the **Error! Reference source not found.**. This figure also shows a list of interchange nodes (Centri di Interscambio Modale Regionale, CIMR), which are subdivided in two hierarchical level:

- CIMR of level 1 (in blue) - more important; and
- CIMR of level 2 (in green) - less relevant).

According to regional legislation³⁵, a cross-border dimension of maritime transport is defined for regions located along the maritime borders, distant up to 150 km from the border. In PRTPL, only the cross-border maritime services linking Trieste are explicitly described. Considering the regional legislation, also Lignano maritime connections should be further assessed, including connection to Piran (38 km straight line distance).

Sustainable urban mobility policies of Slovenian state-border municipalities

Sustainable Urban mobility plans of Slovenian state-border municipalities Koper, Nova Gorica and Sežana express support for development of cross-border public passenger transport.

The strategic aim of the Municipality of Koper is the improvement of international connection of public passenger transport between Slovenia and Italy, including maritime passenger transport. The strategy also fully supports setting up of a network of light rail, which would enable connection of local and cross-border centres and airports.

The strategy of the Municipality of Nova Gorica is to become the centre of a wider near-border area for integrated traffic planning and management. It is planned to establish a railway hub Gorizia-Nova Gorica-Šempeter-Vrtojba and a cross-border circular line network, which would improve accessibility to the wider cross-border urban area (Nova Gorica (SI)-Šempeter (SI)-Gorizia (IT) and increase the attractiveness of the cross-border natural park Soča (SI)/Isonzo (IT). A feasibility study on cross-border public passenger transport to tourist areas (e.g. Braniška valley, Posočje, Vipava valley, etc.) is planned.

Sežana Municipality is supporting development of its territory as a strategic transport link in the ITA-SLO CB area. The efforts are focused on establishment of railway and bus connections among Sežana-Villa Opicina-Trieste and on revitalisation of Kreplje-Rupino-Villa Opicina railway line.

The SUMP developed by the municipalities of Piran, Koper and Izola support development of cross-border maritime public transport services as well as plan to develop of an integrated bike sharing system.

Recommended strategic measures from EU projects

³⁵ Regional law 20 August 2007, n. 23.

The most important EU projects referring to the ITA-SLO CB transport issues are shortly presented below.

TRADOMO project was focused on CB area between municipalities Koper (SI) and Muggia (IT) and CB area among municipalities Gorizia (IT), Nova Gorica (SI) and Šempeter-Vrtojba (SI). The following measures were proposed to improve public passenger transport:

- Area between municipalities Koper (SI) and Muggia (IT):
 - introduction of a common intermodal point in Lazaret (SI),
 - extension of Trieste bus line no. 31 to Hrvatini (SI),
 - introduction of new international line Koper (SI)-Hrvatini (SI)-Muggia (IT) and
 - joint planning of public passenger transport among municipalities with core lines:
 - Koper (SI)-Kolomban (SI)-Chiampore (IT)-Muggia (IT),
 - Koper (SI)-Cerej (SI)-Muggia (IT) and
 - Koper (SI)-Ankaran (SI)-Lazaret (SI)-Muggia (IT).
- Area among municipalities Gorizia (IT), Nova Gorica (SI) and Šempeter-Vrtojba (SI):
 - introduction of a common intermodal point near railway station Nova Gorica (SI),
 - extension of Gorizia bus line no. 3 and 5 (IT) to Šempeter pri Gorici (SI),
 - increase the frequency and a route change on the international urban line Gorizia (IT)-Nova Gorica (SI),
 - extension of urban lines (SI) from Vrtojba (SI) to Miren (SI), crossing Italian side,
 - bilateral agreement on cabotage on urban cross-border area and extension of Italian urban line no. 1 to Nova Gorica (SI)-Grčna (SI)-Solkan (SI),
 - implementation of electronic displays on enter points.

An overview of cross-border mobility across the Alpine Region with a focus on daily commuting has been prepared as a part of the **ARPAF project**. The analyses on cross-border commuting clearly underlined high relevance of cross-border commuting within the EUSALP perimeter. Secondly, the analyses pointed to specific focusses to take on in order to achieve cross-border mobility patterns change: involve political decisions, declare priorities and research dependencies of mobility patterns. Improvement of cross-border mobility facilities has to play an important role when addressing common CB challenges on macro-regional level.

The **INTER-CONNECT project** is supporting improvements of intermodal connections and accessibility pivoting on the existing maritime services connections in Trieste. To improve existing cross-border maritime services and their accessibility and interconnection with public transport services the following measures were recommended for Trieste sea port:

- promoting interventions to improve infrastructure accessibility from/to the Pier IV in Trieste passenger terminal - link to the Via Cavour-Via Porto Vecchio-Passenger Terminal-Pier IV railway station,
- promoting initiatives for passenger infomobility system in the Trieste port passenger terminal - tourist info (routes, areas of interest, existing applications, ...) and local transport info,

- promoting the centralization of maritime LPT services at the Pier IV Passenger Terminal,
- in synergy with the ongoing initiatives, a promotion of sustainable mobility solutions (e.g. bike sharing) at the Pier IV Passenger Terminal and
- promotion of sustainable tourism.

The **INTER-CONNECT project** is also addressing assessment of the potential and development of a new maritime service linking Trieste (IT), Muggia (IT) and Koper (SI). The results of analyses show a relevant lack of connectivity with respect to mobility needs of both residents and tourists. Hence, different options for new waterborne service are to be investigated through synergy measures, also taking into account synergies with other modes of transport (including cycling tourism).

The **ICARUS project** is an on-going project, expected to finish at the end of the next year. It intends to activate a mobility behavioural change from personally owned transport modes towards sustainable multimodal seamless solutions, using the concept “Mobility as a Service”. Within this project, Friuli Venezia Giulia Region (FVGR) is testing different solutions:

- an intermodal bike/rail solution (Wheeling ramps) to strengthen and link CAAR cycle path along underpasses at 11 railway stations,
- an extension of a public transport service during weekends and bank holidays, tailored for forming round trip CAAR and Parenzana cycle paths networks and
- digital information and integrated travel planning towards the Adriatic coast.

The project is also includes Metropolitan City of Venice with the setting up of integrated facilities and tools for fostering bike-bus-train-ferry intermodality underpinning tourist itineraries across the coastal areas.

CROSSMOBY is also a project underdevelopment, planned to be completed in November 2021. The main project objective is to make mobility in the cross-border area more sustainable. The activities are focused on the instigation of more environmentally friendly services and on the elaboration of an action plan for a sustainable mobility in the area and on the adoption, development and coordination of local Urban Sustainable Mobility Plans. In September 2018 the CROSSMOBY project launched a new direct Venice-Trieste-Ljubljana direct train. The project is also analysing cross-border maritime connectivity between Slovenia and Friuli Venezia Giulia Region (FVGR).

Port city Trieste (Italy) participated in the **CIVITAS PORTIS project** along with four other European ports. Within the project, City of Trieste (Italy) developed an integrated transport strategy (SUMP), which includes transformation of the Old Port and its connection to the later-developed New Port in the city of Trieste.

In the context of the **CONNECT2CE project** an integrated cross-border ticket on the route Ljubljana (SI) - Villa Opicina (IT) - Trieste (IT) was launched on March 2019, combining a long distance train service and a local bus service operated by Trieste Trasporti. The project also developed territorial strategies for improvement of accessibility of border and cross-border regions. The strategy emphasised a need for a coordinated approach of transport authorities from

each side of the border (e.g. establishment of joint commission). Several other strategy measures suggest:

- a regulated EU approach on cross-border public transport,
- involvement of local transport authorities and operators in the process of defining of the cross border area and lines,
- upgrading of the cross-border line network model by co-financing of additional stops and cross-border lines in the CB area for better connection to regional and local transport,
- achievement of transport seamlessness through efficient and well managed integration of tariff schemes and ticketing systems on CB lines and backed by an integrated infomobility system.

4.2 REVIEW OF PRIORITIES AND SUGGESTIONS BY THE RELEVANT STAKEHOLDERS

4.2.1 Identification of relevant stakeholders

The relevant stakeholders dealing with development, implementation and operation of international and cross-border public passenger transport services in Slovenia-Italy cross-border area were identified as follows:

- **transport and regional development public authorities on national, regional and local levels**, which are responsible for planning and operation of passenger services in cross-border area,
- **public passenger transport operators**, which are responsible for operation of public passenger transport on international, national and local levels in cross-border area,
- **European Grouping of Territorial Cooperation - EGTC**, which links regional and local authorities and other public bodies from Slovenia and Italy, to team up and deliver joint services on cross-border area, and
- **international organizations**, committed to supporting European integration and sustainable development through cooperation between and among Member States and further with the European Union.

74 relevant stakeholders have been identified in total. A list of the identified relevant stakeholders is provided in Appendix 3 (page 90).

For analysis, the stakeholders have been divided in following groups:

- Public authority
- Transport operators
- European grouping and
- International organization.

The **public authority group** includes:

- National and regional authorities for development of cross-border (international) and inter-urban passenger transport on both sides of border and
- 50 Italian local authorities - in Italy they have no particular authority of cross-border transport development and 11 Slovenian municipalities, among them only the two urban municipalities have powers to expand the existing urban transport systems across the border; they were invited to express their interest as well.

The transport operator group includes:

- 3 bus operators from Slovenia and 2 bus operators from Italy and
- 2 railway operators, 1 from Slovenia and 1 from Italy.

In Italy-Slovenia cross-border area, only one **European grouping for territorial cooperation** has been established and one **international cross-border cooperation organization** has been identified.

4.2.2 Interviewees

The questionnaire for assessment of territorial needs, strategic priorities and proposals for public passenger transport development measures in the Italy-Slovenia CB area was sent to 74 relevant stakeholders (Annex 1). A response was obtained from 27% respondents, among them 20% of all identified authorities and 71% of all identified transport operators as well as from the European grouping and the international organisation, as shown in **Error! Reference source not found..**

Table 18: Structure of respondents to the questionnaire

Stakeholder group	Number of returned fulfilled questionnaires	Share of all identified stakeholders
Public authority	14 of 65	22%
Public passenger transport operator	5 of 7	71%
European Grouping of Territorial Cooperation	1 of 1	100%
International organization	1 of 1	100%
TOTAL	21 of 74	28%

4.2.3 Feedback analysis

Feedback of respondents is presented below for each topic respectively.

4.2.3.1 Planning, registration and operation of cross-border lines

Introduction of a new cross-border line is largely based on initiative of each transport operator. Planning of a new line is subject to the own market research and expressed demand for transport between the two cross-border points. Important drive for a new line is availability of financial support through state aid or international projects focussing on cross-border transport.

Also geographical conditions play an important role in recognising the market potential. Rural areas are usually not attributed high potential for cross-border mobility and are basically only connected to local and regional centres. On the other hand several local authorities pointed out opportunity of cross-border connections in those areas in support and promotion of local sustainable tourism and economic resources.

Several cross-border initiatives and EU projects proposed new cross-border lines in the past. Those initiatives are welcome but the problem is that some initiatives lack the operational level to put the projects in practice. On the other hand many initiatives remain an episodic action that lasts too short time to impact the mobility change and allow further operations on commercial basis.

Respondents pointed out the absence of uniform rules on both sides of the border and lack of cross-border agreements defining the rules and conditions to be met when introducing a cross-border line. They should bring about alleviation of administration issues, found in lengthy registration and endorsement procedures for new cross-border lines.

To alleviate the administration procedures and support cross-border line planning it is suggested to:

- provide state aid and incentive schemes for cross-border public passenger transport services,
- assure straightforward involvement of municipalities and other interest groupings in organization and implementation of cross-border passenger transport services,
- present clear political interest to eliminate the administrative obstacles,
- implement regional planning arrangements on cross-border public transport and
- provide promotion of services in the respective target territories.

Absence of sectorial cross-border agreements also impacts operation of cross-border lines. The fact that the cross-border lines are not subsidized, market oriented makes a great obstacle for the efficient operation according to the needs of population. Without any agreements or coordination on the higher level it is difficult to harmonise timetables. Also the current cabotage regulation brings about many issues in cross-border lines operation.

More attention should be focused on better link between cross-border public passenger transport services and various last mile mobility services (shared mobility).

There is a huge deficiency in coordinated promotion activities that would help achieve better ridership on the existing lines, raise opportunities for initiation of additional cross-border lines, and consequently enhanced public transport sustainability.

4.2.3.2 Determination of cross-border (international) ticket price

Cross-border tickets are not subsidized and therefore they are not bound to reductions and special entitlements listed in the national legislation. Ticket price is mostly based on direct

transport service operational costs, also including sales and reservation cost, infrastructure use charges and partly the administration overhead (line registration, information systems etc.). For making the ticket prices more attractive to daily commuters the subsidizing system should be encouraged.

Italy subsidizes ticket price for cross-border services, which are considered as part of the public service obligation. Currently it only applies to the train service. This makes it possible to achieve more attractive ticket prices and promotion of cross-border public transport, which should eventually be extended to other transport modes. In Slovenia all cross-border public transport lines are treated as commercial lines, except for railway where the cross-border lines on Slovenian part is part of PSO and subsidized by the state.

4.2.3.3 Monitoring of the occupancy of the cross-border (international) line

Transport operators monitor cross-border lines to assess their profitability. The assessment is mostly based on the volume of ticket sale, but also on periodic passenger counting or regular keeping records on vehicle transported passengers' volume. On-line booking is an efficient tool where only on-line ticket sale is provided.

4.2.3.4 Containment of Covid-19 epidemic impact

Covid-19 epidemic brought immense drop in cross-border lines operation. Most of the lines did not operate due to the border closure and after the cancellation of measures a very large decline of passenger has been noticed. During this period also non-operational cross-border activities have stopped (e.g. planning of new lines).

Italy and Slovenia have not coordinated containment measures that should be applied in public transport therefore different measures apply to the cross-border lines at each side of the border. This brings additional burden to the operations. A particular problem emerged in the railway transport where different subcontractors in each country provide hygiene and cleaning service, whereas the vehicles of the train cross the border.

To avoid issues brought about by different measures they should be coordinated between the two countries and jointly planned for the purpose of the smooth cross-border public transport. A joint ad-hoc coordination body could be help overcome these obstacles.

Covid-19 has also pointed out importance of having contactless ticketing and payment systems. Transition from cash payment and paper ticketing to online purchase, electronic (e.g. smart card) and mobile ticketing (smart phone to purchase and store the ticket) and card payments should be promoted as a long term solution.

4.2.3.5 Measures of CB public transport improvement by stakeholders

All groups of stakeholders are unanimous that **introduction of a single cross-border passenger information portal** is the crucial measure to take. It should provide integrated timetable search engine, online ticket purchasing and other relevant information for passengers. The information portal can significantly contribute to both promotion as well as use of cross-border passenger transport. Ridership in CB transport can also be significantly improved through **construction and functional arrangement of cross-border intermodal transfer points that allow easy switching between different modes of transport and introduction of a single cross-border ticket.**

Public authority group considers it necessary to include **cross-border public transport as a part of a joint public service, each country on its side of the border**, thus endowing them certain control and provide benefits to the passengers. The group also encourages **establishing of a cross-border coordination body** to be responsible for coordination of lines according to the needs and proposals by end users, harmonization of timetables and formulation of uniform rules of cross-border transport services planning, operation and use.

Forming of **cross-border mobility statistics service** for regular monitoring of cross-border mobility trends might not have an impact on improvement of the use of existing cross-border services, but it can make a significant impact on cross-border line planning. Special attention should also be paid to **promotion and advertising of cross-border transport services and providing efficient ICT services to the citizens/users (payment, ticketing).**

Furthermore, the stakeholders provided additional concrete suggestions and proposals for enhancement of cross-border public transport in the ITA-SLO CB area:

- Regulation of cross-border line as a special type of international transport service. Regulation should provide definition of the border areas and exemption from the cabotage for the cross-border lines operating within those areas, thus enabling passenger collection on both sides of border.
- Conclusion of a bilateral agreement to facilitate cross-border bus services.
- Setup of a cross-border working group composed of professionals in handling of transport and mobility, with aim to improve shared planning of transport services that would in a long-term form a unified intermodal network of cross-border transport throughout the cross-border area.
- Simplification of international line registration procedures.
- Regulative support to joint procurement procedures for cross-border transport services and provision of public co-financing of cross-border transport services.
- Simplification/cancellation of lengthy border procedures for cross-border railway transport services.
- Conduction of targeted studies on international mobility in CB area (e.g. interviews to citizens and users) resulting in set-up of pilot cross-border lines. The study should define the lines and timetables based on acquired origin and destination mobility data. Profitable cross-border lines are usually limited to urban areas, with a high population density,

relatively short distances and a large daily fluctuation (e.g. cross-border area of Nova Gorica and Gorizia).

- Planning of cross-border lines should consider potential of tourism in the cross-border area (e.g. in support to slow mobility such as cycling, hiking). In this view, high potential of public transport connectivity between Resia, Tarcento and Bovec was identified to effectively create a borderless area and increase its touristic value.
- Introduction of cross-border public transportation via sea (boats and ferry boats).
- Revision of lines layout and infrastructure upgrade in order to reduce travel times, remove of unused and take in more attractive stops.
- Encouraging of cross-border MaaS services to obtain integration of different services within the same ICT tool/App (e.g. buses, trains, bikes, etc.) at a cross border level.
- Equipment of interchange points with intermodal infomobility systems.
- Overcoming language barriers with a widespread multilingual information.

4.3 PROPOSALS FOR IMPROVEMENT OF CROSS-BORDER CONNECTIVITY

The aim of the proposals for improvement of cross-border connectivity is to suggest solutions for the challenges derived from current organisation and operation of CB public transport between Italy and Slovenia.

4.3.1 Challenges

Challenges in cross-border connectivity are identified on the basis of results and conclusions derived from analyses carried out across this study and declared priorities of the CB public transport stakeholders. The challenges are grouped in three categories according to the connectivity aspect they address:

- Administration and organisation,
- Transport operations and
- Information technology support.

The identified challenges are presented in the table below

Table 19: List of identified challenges in CB connectivity

No.	Identified challenge
A.	<i>Administration and organisation</i>
A1.	EU legislation does not provide special status for CB lines in a similar way as for regional and national lines, in pursue of better CB connectivity; also the current cabotage regulation brings about many issues in cross-border lines operation, not allowing local passengers to board a bus;

A2.	Cross-border tickets are generally not subsidized ³⁶ and therefore they do not follow reductions and special entitlements scheme in line with the national legislation;
A3.	A bilateral agreement on the regulation of personal transport and land and maritime transport between Italy and Slovenia has had a standstill status since the day of Slovenia's accession to the EU and is not applied in practice; the absence of uniform rules affects the introduction and operation of new CB lines;
A4.	Modal split data on cross-border transport are not available;
A5.	An information system for registration, management and analyses of international bus lines not exist; all data at Slovenian Ministry of Infrastructure are kept in paper, data are not structured and coded; the registration and endorsement procedures for new CB lines are therefore lengthy;
A6.	Sources of geo-coded data (on population, economic activities, tourist attractions, ...) are different national databases; they have different data structure (attributes) and definitions;
A7.	The main issue of train border crossing at Villa Opicina are changing of the train crew and undertaking of certain technical procedures, which takes up to 20 min per stopping;
A8.	No coordinated containment measures and implementation protocols that should be applied in public transport during COVID-19 epidemic;
A9.	Deficiency in coordinated promotion activities to achieve better ridership on the existing lines and to raise opportunities for initiation of additional cross-border lines;
A10.	The existing national, regional and local strategies are only binding the authority on the one side of the border; the strategies and recommendations developed within EU programs are only project-oriented and mainly focus on parts of CB areas, therefore a comprehensive approach to the planning and development of CB public transport is missing (a comprehensive study and entailing integrated strategy of CB area);
A11.	Introduction of a new cross-border line is largely based on initiative of each transport operator and on availability of financial support through state aid or international projects; many initiatives remain an episodic action that lasts too short time to impact the mobility change and allow further operations on commercial basis;
B.	<i>Transport operations</i>
B1.	<u>Car transport</u> in both FVGR and Slovenia takes more than 90% modal share;
B2.	<p><u>CB railway transport:</u></p> <ul style="list-style-type: none"> - Lack of good connection of national (regional) railway networks on each side of the railway network; only two border crossings link national (regional) railway networks along the ITA-SLO border, where only one (Villa Opicina/Sežana) is active for passenger transport; the missing links between national railway networks are not overcome by CB bus connections, except in Gorizia/Nova Gorica; - Existing railway lines only connect sufficiently Slovenian CB and hinterland centres to CB town Villa Opicina, connections to Trieste and to Ronchi d. Legionari airport with

³⁶ Subsidy is only available through specific activities, like EU projects (e.g. CROSSMOBY)

	<p>2 and 1 departures daily, respectively, does not allow commuting and regular use of the airport;</p> <ul style="list-style-type: none"> - At the location of Gorizia - Nova Gorica township a railway link exists between Gorizia Centrale station (IT) and Nova Gorica station (SI). The railway link between the stations takes a very long bypass through Šempeter pri Gorici (SI) and is not suitable for daily commuting; - Smaller settlements in Slovenian mountains and seaside areas, which are of important tourist interest (e.g. Kobarid, Kranjska Gora, Piran, Most na Soči and Portorož) as well as Italian seaside towns Muggia, Grado and Lignano, do not have a direct access to railway network;
B3.	<p><u>CB bus transport:</u></p> <ul style="list-style-type: none"> - Only the most important cross-border and hinterland centres from the opposite sides of state border are connected to each other by bus (less than 15%); coastal centres Muggia, Grado and Lignano have no direct bus connection to Slovenia; smaller agglomerations in hilly areas (Tarvisio - Kranjska Gora, Kobarid - Cividale del Friuli) and bigger centres Udine and Gorizia have relatively few CB connections; - Many Slovenian regional and national bus lines internally connecting CB and hinterlands centres in the lead to border crossings but have no further connection over state border or timetable connection with the local transport in Italy; - In several cases CB bus lines are allocated for use by predominantly restricted passenger category (e.g. workers), which reduces the actual connectivity; - Bus transport time is especially inefficient on longer distances, mainly also on account of the intermediate stops; in certain cases it can be almost doubled in favour of the car (e.g. Tarvisio-Ljubljana or Pordenone-Ljubljana lines).
B4.	<p>Only 2 regular ferry lines are connecting Italian and Slovenian coastal CB centres Trieste and Piran and one line between Piran and Venice during the summer season;</p>
B5.	<p>Only few CB and hinterland centres provide the passengers with an option to use more than one CB transport mode; CB train is only available in 7 of 27 points and CB ferry in 2 of 11 observed seaside points;</p>
B6.	<p>Lack of comprehensive planning and implementation of intermodal public passenger transport infrastructure, also when coming to last mile mobility services (shared mobility);</p>
C.	<i>Information technology support:</i>
C1.	<p>Infomobility systems at regional and national level include modern information and sales channels, as opposed to CB infomobility, which is dispersed among single operators, making the information hardly accessible to public transport users; the information is usually available on the operator's web page and additionally at the ticket sale points only; except for railways, there is no EU obligation for integration of infomobility systems;</p>
C2.	<p>Except for sporadic pilot actions, there is no CB ticketing system, no tariff harmonisation, no intermodality and no infomobility integration;</p>
C3.	<p>Italy and Slovenia are implementing different smart card ticketing technologies, which</p>

are not compatible;

4.3.2 Proposed measures by the study

Based on the above identified challenges in ITA-SLO CB connectivity, which draw from the analysis of the situation, review of institutional priorities as well as and priorities and suggestions of the relevant stakeholders, the measures are proposed with aim to rectify the exposed issues and to enhance connectivity by using the specific territorial opportunities and new technologies. The measures tend to promote availability of existing CB public transport offer, enhance the existing offer, improve CB coordination of planning and operation and provide better information technology support.

Error! Reference source not found. lists the proposed CB connectivity improvement measures. They are grouped in three categories, following the structure of the identified challenges: administration and organisation, transport operation and information technology support. For each measure, an explanation of the expected impact is given and reference to the identified challenges in **Error! Reference source not found.**, which are addressed by the particular measure.

Table 20: List of proposed measures for improvement of the CB public passenger transport

No.	Identified challenge (reference to Error! Reference source not found.)	Proposed improvement measures	Expected impact of measures
1.	<i>Administration and organisation</i>		
1.1	A1, A11	Changes/amendments of EU legislation: <ul style="list-style-type: none"> - to enable public transport operation on pre-identified CB transport zones as an integrated/joint public service, - to enable authorised bodies a joint procurement of CB public transport services and - to exempt cross-border lines from the cabotage; 	<ul style="list-style-type: none"> - Transport authorities from both border sides exercise certain control on CB transport development - Easier planning and operation of CB public transport, better efficiency of transport - Better offer for passengers
1.2	A3, A4, A6, A7	Conclusion of a bilateral agreement defining CB public transport zone	- Reference to legal framework for planning and operation of joint CB

No.	Identified challenge (reference to Error! Reference source not found.)	Proposed improvement measures	Expected impact of measures
		between Italy and Slovenia and responsibilities for the planning, management and operation of CB public transport within those zones and relation to the local transport;	public transport services - Elimination of administrative obstacles for planning, introduction, management and operation of CB lines - Simplification /cancellation of lengthy border procedures for cross-border transport services.
1.3	A3, A9, A10, C2	Establishment of a CB coordination body to be responsible for coordination of lines according to the needs and proposals by end users, harmonization of timetables and formulation of uniform rules of CB transport services planning, operation and use	- Coordinated planning of CB lines and better offer (layout, timetables) - Harmonised ticketing (tariff...) - Easier operation and use of transport services - Involvement of municipalities and other interest groupings in planning of CB passenger transport services - Coordinated promotion activities
1.4	A2	Introduction of state aid and incentive schemes for CB public passenger transport services	- Better offer - Lower ticket prices - Assuming impact on CB transport
1.5	A5	Information system for registration, management and analyses of international bus lines	- Simplification and speeding up inception of new CB bus lines - Structured and coded data as an input for CB infomobility portal for easier processing
1.6	A4	Roll-out of CB mobility statistics service	- Better monitoring of CB mobility trends for more efficient planning
1.7	A8	Establishment of a joint ad-hoc coordination body to plan joint measures for the purpose of the smooth CB public transport operation during Covid-19 epidemic.	- Joint planning of the measures to avoid contradictory actions and easier implementation - Smoother CB public transport during the epidemic
1.8	A9	Joint plan for promotion and	- Better penetration of information

No.	Identified challenge (reference to Error! Reference source not found.)	Proposed improvement measures	Expected impact of measures
		advertising of CB transport services	and raise of awareness of users about CB transport services
2. Transport operations			
2.1	A10, A11 B1, B2 B3, B4, B5, B6	Elaboration of targeted studies on CB intermodal mobility for the whole CB transport area	<ul style="list-style-type: none"> - Defining the lines, intermodal points and timetables in response to CB demand - More efficient offer of CB transport services
2.2	A10, A11, B1, B2, B3, B4, B5, B6	Adoption of a comprehensive CB strategy and action plan on the development of sustainable CB public transport on the whole CB transport area	<ul style="list-style-type: none"> - Comprehensive public transport development in the whole CB region - Monitoring of impact of implemented measures on the mobility change - Better offer of CB transport services
2.3	A10., A11., B.2., B.5.	<p>Development of a backbone railway line, connecting CB and hinterland centres in Italy and Slovenia, based on train connection between Ljubljana and Trieste/Ronchi dei Legionari:</p> <ul style="list-style-type: none"> - a border stop at Villa Opicina, a gateway for intermodal transport to Trieste (e.g. by shuttle), - possible transfer point at Aurisina (IT) for the passengers bypassing Trieste on the way to Venice, Ronchi dei Legionari or Udine, - extension of the Ljubljana - Ronchi dei Legionari line to Venice (a new direct Ljubljana - Venice line); - keep departures from Ljubljana to 	<ul style="list-style-type: none"> - Better and more attractive connection between Ljubljana and Venice - Connect Trieste to Ljubljana by also using intermodal connection (Villa Opicina shuttle)

No.	Identified challenge (reference to Error! Reference source not found.)	Proposed improvement measures	Expected impact of measures
		Udine.	
2.4	B2	Introduction of bus lines to connect the missing railway infrastructure links	<ul style="list-style-type: none"> - Better offer of CB transport services - Support for tourist development in remote areas
2.5	B6	Construction and functional arrangement of CB intermodal transfer points	<ul style="list-style-type: none"> - Smoother CB public transport - More efficient use of resources
3. Information technology support:			
3.1	C1	Integration of scattered data from separated infomobility portals to a single CB passenger information portal with integrated timetable search engine, online ticket purchasing and other relevant information for passengers with multilingual support.	<ul style="list-style-type: none"> - Raising awareness of transport services availability - Raising ridership - Easier use of transport services - Better promotion of CB transport services
3.2	C2	Introduction of a single CB ticket	<ul style="list-style-type: none"> - Easier use of transport services within the CB transport region - Raise of ridership
3.3	C2, C3	Integration of ticketing systems based on interoperability standards, e.g. AZTEC bar code, issued by UIC	<ul style="list-style-type: none"> - Easier and more transparent CB operation of a single transport system - Easier use of transport services

5 SUMMARY

Italy - Slovenia cross-border border (ITA-SLO CB) area is stretching over 232 km and is situated in Central Europe touching the Alps in the north and bordering the Mediterranean Sea spreading to Italian region **Friuli Venezia Giulia** at the West and **Slovenia** at the East. The most important places on Italian side are represented by Trieste, Udine, Gorizia, Tarvisio and hinterland city of Venice, whereas Slovenian side is depicted by Kranjska Gora, Nova Gorica, Postojna and Koper and hinterland city of Ljubljana.

Although, in geographical terms and also from a historical point the area forms a uniform cross-border region that has been split by the national border of the two countries, namely Italy at the western and Slovenia at the eastern side of the border, it was historically faced with obstacles in coherent development, which produce specific challenges to be faced with. Commuting and cross-border cooperation are part of the daily life of people living close to the borders, thus bringing about close connections between the neighbouring regions of Friuli Venezia Giulia and Slovenia. The Gorizia on Italian side and Nova Gorica on the Slovenian should be pointed out as remarkable border township where two cities, each on one side of the border share the same city square. The ongoing discussion about investment in railway infrastructure aimed at better connection of Nova Gorica and Gorizia could pave the way to additional opportunities in terms of improved connections in cross-border train services (e.g. extension of the lines from Gorizia to Jesenice via Nova Gorica).

Despite historic, cultural and geographical connection the ITA-SLO CB area still suffers from the delimitation induced by the historical events in the second half of the 20th century. This level of integration of the labour market that has been assessed as lower than the EU average. On the other hand, the area boasts with many historical and natural marvels that generate huge mobility for leisure and touristic purposes.

In general mobility is much greater in the southern part of the region with plains, coastal area and bigger agglomeration in contrast with the northern part that where less populated, mountainous and rural areas are prevalent.

If regional and national public transport in Italy and Slovenia is well responding and is steadily developing according to the demands of the local population and tourists, this cannot be claimed for the CB mobility.

There is only one railway connections between the countries. It extends from Ljubljana via Postojna and Sežana to finish either in Villa Opicina, Trieste or Udine. The lines from Slovenian centres Ljubljana Postojna and Sežana mostly finish at the first cross-border station at Villa Opicina. Connections with other Italian centres are low, Trieste - 2 times daily, or completely insufficient (Udine, FVG Airport). Long distance lines don't even exist, e.g. Ljubljana - Venice.

As previously mentioned, maritime transport, even if relying especially on cross-borders seasonal lines, has still significant room for improvement.

Connection to the international airports in the region is scarce. The Slovenian points Ljubljana, Postojna or Sežana are only connected by one pair of trains daily, which doesn't meet the level of demand of regular passengers.

Bus connections are more frequent and with more branched connectivity but they are mainly concentrated to the southern part of the CB region by connecting some bigger centres as Trieste and Venice in Italy to Koper, Sežana, Portorož, Postojna and hinterland city of Ljubljana in Slovenia. There is no connection from Slovenia to Italian coastal centres Muggia, Grado and Lignano and very few CB connections of Udine, Gorizia, Nova Gorica and Tarvisio. Statistics shows that less than 15% mutual connections among CB centres exist. On the other hand, bus connection between Venice and Ljubljana is regular and frequent with departures on hourly basis.

Bus lines are operated on purely commercial basis, therefore the information on the service very dispersed. No integrated information site is available for the traveller to get the information on departures, purchase tickets or get other travel information. As cross-border transport is left to the private initiative the cross-border integration practically does not exist. The only bright exception is timetable integration of bus transport in municipalities of Gorizia and Nova Gorica but passengers cannot use the same ticket at both operators, providing the municipal transport.

Integration and intermodality of cross-border transport is practically not existing. There is no cross-border ticketing system, no tariff harmonisation, no intermodality and no infomobility integration. Each transport provider/carrier usually provides its own web page and optionally a call centre for providing information on routes, timetables, ticket purchase and reservations but no on-trip information. Such fragmentation makes passengers struggle to only get the information on the available transport offer let alone passenger friendly travel experience and flexibility. Very important harmonisation of municipal transport has taken place in the CB township of Gorizia and Nova Gorica providing joint operation of CB municipal line and timetable harmonisation, but the only real example of integration was a CONNECT2CE project pilot action, connecting a train from Ljubljana to Villa Opicina by train and Villa Opicina the Trieste centre where all substantial integration elements. Integration of ticketing systems, tariff harmonisation, common infomobility portal, intermodality, multi-operation, ticket revenue sharing could serve as a model for other initiatives or better systematic approach to bring forward better efficiency of CB public transport.

A tendency of local communities and transport operators is to extend the existing urban and extra-urban bus lines across the border from both sides of the border, by duly raising the frequency of departures and harmonising timetables of different bus operators. Here the attention should be paid to identify the bottlenecks and to several technical and administrative barriers.

Based on the results and conclusions derived from analyses carried out across the study and declared priorities of the CB public transport stakeholders, the challenges in the ITA-SLO CB public transport connectivity were identified in terms of administration and organisation, transport operations and information technology support. In order to rectify the exposed issues

and to enhance CB connectivity, the strategy measures were proposed by taking into account the identified CB connectivity challenges.

The measures tend to promote availability of existing CB public transport offer, enhance the existing offer, improve CB coordination of planning and operation and provide better information technology support. Among them the pivotal improvement measures need to be emphasised:

- development of a single CB infomobility portal for the entire SLO-ITA CB area that jointly provides information to the end users on international and CB connectivity but also local public transport information. The multi-operator and multimodal information on the available lines and timetables includes search engine and interactive route planner;
- common definition of a ITA-SLO CB transport area endorsed by Italian and Slovenian side and elaboration of a comprehensive study of territorial needs, involving different decision levels of detail serving as a common bilateral development and operational strategy (definition of needs, multimodal transfer points, lines, implementation measures etc.);
- multi-operator and multimodal harmonisation of timetables;
- conclusion of an agreement between Italian and Slovenian authorities for the establishment of a joint body for planning and management of cross-border public transport;
- better promotion of CB public transport (for commuting and tourist purpose).

Figure 35: Overview of available ITA-SLO CB and international public passenger connectivity (rail-train, road-bus, maritime-ferry)

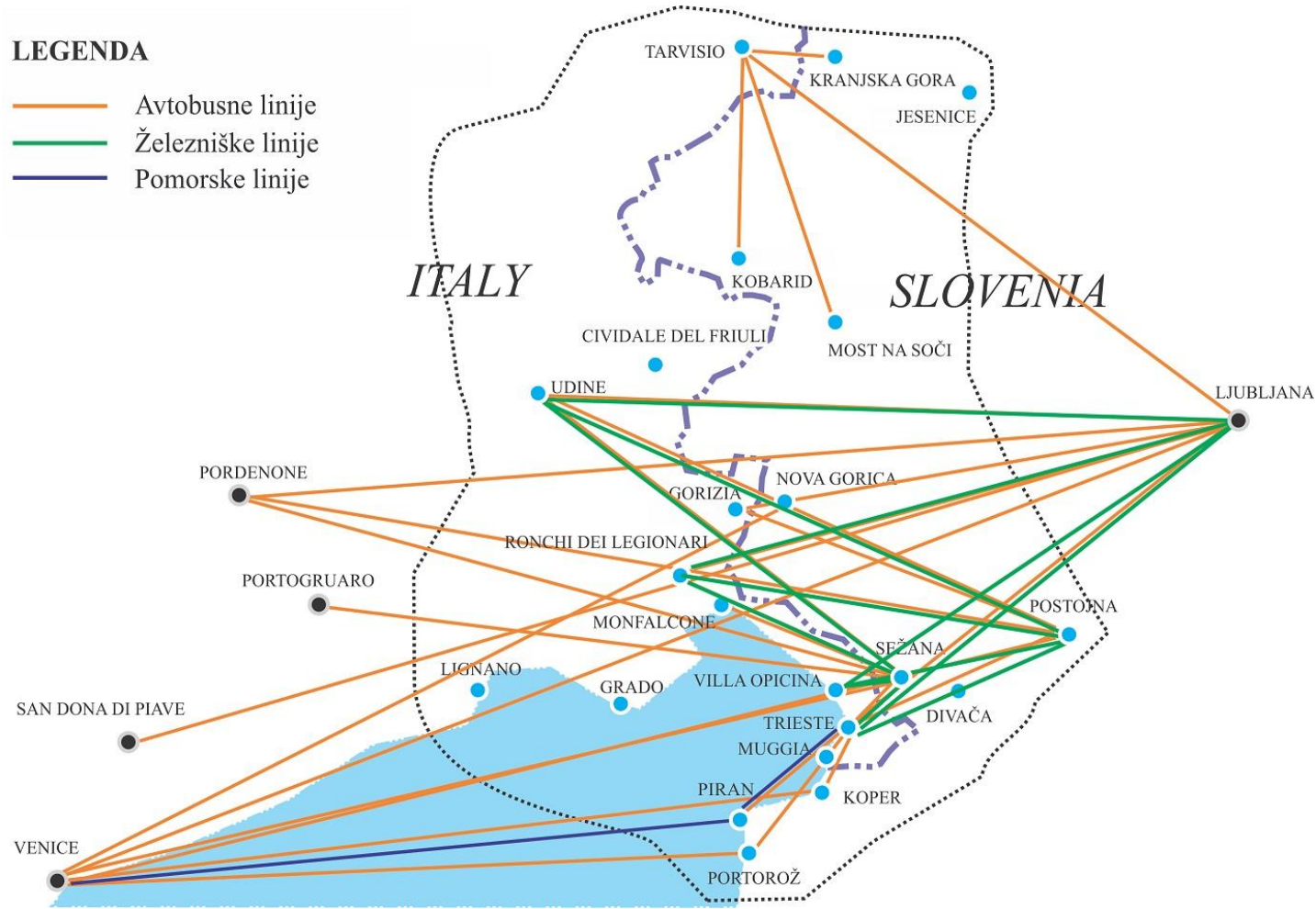

6 APPENDIX 1: CHARACTERISATION OF CB AND HINTERLAND

SLOVENIA

Cross-border centres:

- **Sežana** (including PT operation across border to Villa-Opicina and Trieste)
- **Divača** (as a hub to tourist attractions in vicinity)
- **Koper** (including urban PT operation in Koper and all cross-border PT to Trieste - Pilot action n. 3)
- **Nova Gorica** (including cross-border PT operation among Nova Gorica and Gorica)
- **Kobarid** (potential PT operation across ITA-SLO border area to Udine and Cividale del Friuli)
- **Kranjska Gora** (potential PT operation across ITA-SLO border to Tarvisio).
- **Postojna** (as a transit city from Ljubljana urban region to Italy)
- **Main touristic areas at Slovenian coastal area (e.g. Piran, Portorož)** where the data on PT is available

Hinterland centres:

- **Ljubljana hub** (main PT terminal and main stopping points in Ljubljana along the itinerary)

ITALY

Cross-border centres:

- **Trieste** (PT connections to Muggia and Koper, Pilot action 1, - including maritime PT operation for Pilot action n.2)
- **Muggia** (for the connections with Koper, since Muggia is a municipality in itself);
- **Gorizia** (cross-border connections, urban and peri urban connections)
- **Udine** (main urban connections of PT to Slovenia)
- **Portogruaro** (as a transit city connecting Venice and Slovenia)
- **Ronchi dei Legionari** (main PT terminal as there is first airport in Italy with a direct rail connection located)
- **Villa Opicina** (even if it is part of the Municipality of Trieste, given the connections between the bus services that arrive in that locality and the Slovenian rail services that are there);
- **Tarvisio** (including main connections of PT to Slovenia (Kranjska Gora))
- **Cividale del Friuli** (including connections of PT to Slovenia (Kobarid))
- **Main tourist coastal areas Trieste to Venice (e.g. Grado, Lignano) in case the potential of Cross-border PT is observed**

Hinterland centres:

- **Pordenone** (as a transit city from Friuli-Venezia Giulia region to Slovenia)
- **Venice** (main connections of PT to Slovenia)
- **San Donà di Piave** (as a stopping point connecting Venice and Slovenia)

7 APPENDIX 2: TRANSPORT OPERATORS IN THE CROSS-BORDER AREA

Operator	Address	Country	Nb. of lines
FLIXBUS ITALIA S.R.L.	CORSO COMO,11, 20154 MILANO	ITA	15
ARRIVA DOLENJSKA IN PRIMORSKA D.O.O.	KOLODVORSKA 11, 6000 KOPER	SLO	6
FlixBus CEE North GmbH	Richard-Strauss-Strasse 32 1230 Dunaj	AUT	4
NOMAGO D.O.O.	VOŠNJAKOVA ULICA 3,1000 LJUBLJANA	SLO	4
D.R.D. TURIZEM D.O.O.	Ulica pri velikih vratih 9,6000 Koper	SLO	3
FLOERENTIA BUS S.r.l.	Via il Prato, 71, 50123 Firenze	ITA	3
RADIKA PREVOZI D.O.O.	CELOVŠKA CESTA 264,1000 LJUBLJANA	SLO	3
DARDANIAT D.O.O.	Veliki Trg 17, 6310 Izola	SLO	2
BOSNAEKSPRES D.O.O.	AŠKERČEVA ULICA 15, 3000 CELJE	SLO	2
Flixbus CEE SOUTH d.o.o.	Pile l.1,10000 Zagreb	CRO	2
Flixbus DACH GmbH	Karl-Liebknecht-Strasse 33, 10178 Berlin	GER	1
PREVOZI IN GOZDARSKE STORITVE BRANKO OGRINC S.P.	GRAHOVO 56, 1348 GRAHOVO	SLO	1
Croatia Bus d.o.o.	Avenija Marina Držića 4, Zagreb	CRO	1
EUROLINES SA	215 AV Georges Clementceau, 92000 Nanterre (F)	FRA	1
FULI INŽENIRING D.O.O.	DRAPŠINOVA ULICA 1B, 3000 CELJE	SLO	1
GASHI TOURS PREVOZI D.O.O.	Struževo 2C, 4000 Kranj	SLO	1
HISAR LJUBLJANA D.O.O.	KOLODVORSKA ULICA 20, 1000 LJUBLJANA	SLO	1
IMER ADEMI S.P.	KOLODVORSKA ULICA 20, 1000 LJUBLJANA	SLO	1
LIBERTY LINES	Via Serraino Vulpitta, 5 Trapani	ITA	1
KB POTOVANJA1 D.O.O., PREVOZ PUTNIKA ZA VIDOVIČI AB (ŠVEDSKA)	TRG OF 13A, 1000 LJUBLJANA	SLO	1
MIRTTOURS PETER MIRT S.P.	BLANCA 32,8283 BLANCA	SLO	1
S.T.A.V. Servizi Transporti Automobilistici spa	Via Trivulzio, 13, 27029 Vigevano	ITA	1
Saiz Tour Romania SRL	Str. Gara de Nord 2, Bukarešta	ROM	1
Segesta Internazionale s.r.l.	Via Parigi 11, 00185 Rim	ITA	1
Sindbad Spolka z Ograniczona Odpowiedzialnoscia	45-144 Opole, ul. Dzialkova 4	POL	1
UNION IVKON	NULL	BUL	1
VOLANBUSZ Kozlekedesi Zrt. Reszere (Nemzeti Kozlekedesi Hatosag)	H-1091 Budapest, Ulloi ut 131	HUN	1

ZHITIJA TURIST D.O.O.	MLINSKA ULICA 1,2000 MARIBOR	SLO	1
-----------------------	------------------------------	-----	---

The transport operators that are operating CB bus lines are marked bold.

8 APPENDIX 3: LIST OF IDENTIFIED RELEVANT STAKEHOLDERS FOR PROVISION AND IMPLEMENTATION OF CROSS-BORDER PUBLIC PASSENGER TRANSPORT SERVICES IN SLOVEIA AND ITALY

	Name of Stakeholder	Country	Group	Activity/responsibility	Total
1.	Ministry of infrastructure	SLO	Public authority	International and inter-urban transport	65
2.	Regione Autonoma Friuli Venezia Giulia	ITA	Public authority	Regional and cross-border transport	
3.	RRA Severna Primorska		Public authority	Operational activities on regional development	
4.	Regionalni razvojni center Koper	SLO	Public authority	Operational activities on regional development	
5.	Mestna občina Koper	SLO	Public authority	Local transport and local development	
6.	Mestna občina Nova Gorica	SLO	Public authority	Local transport and local development	
7.	Občina Kanal	SLO	Public authority	Local development	
8.	Občina Bovec	SLO	Public authority	Local development	
9.	Občina Vrtojba	SLO	Public authority	Local development	
10.	Občina Komen	SLO	Public authority	Local development	
11.	Občina Brda	SLO	Public authority	Local development	
12.	Občina Kobarid	SLO	Public authority	Local development	
13.	Občina Tolmin	SLO	Public authority	Local development	
14.	Občina Sežana	SLO	Public authority	Local development	
15.	Občina Hrpelje-Kozina	SLO	Public authority	Local development	
16.	Comune Trieste	ITA	Public authority	Local development	
17.	Comune di Muggia	ITA	Public authority	Local development	
18.	Comune Duino Aurisina	ITA	Public authority	Local development	
19.	Comune Monrupino	ITA	Public authority	Local development	
20.	Comune San Dorligo della Valle	ITA	Public authority	Local development	
21.	Comune Sgonico	ITA	Public authority	Local development	
22.	Comune Capriva del Friuli	ITA	Public authority	Local development	
23.	Comune Cormons	ITA	Public authority	Local development	
24.	Comune Doberdò del Lago-Doberdob	ITA	Public authority	Local development	
25.	Comune Dolegna del Collio	ITA	Public authority	Local development	
26.	Comune Farra d'Isonzo	ITA	Public authority	Local development	
27.	Comune Fogliano Redipuglia	ITA	Public authority	Local development	
28.	Comune Gorizia	ITA	Public authority	Local development	
29.	Comune Gradisca d'Isonzo	ITA	Public authority	Local development	
30.	Comune Mariano del Friuli	ITA	Public authority	Local development	
31.	Comune Medea	ITA	Public authority	Local development	
32.	Comune Monfalcone	ITA	Public authority	Local development	
33.	Comune Moraro	ITA	Public authority	Local development	
34.	Comune Mossa	ITA	Public authority	Local development	

	Name of Stakeholder	Country	Group	Activity/responsibility	Total
35.	Comune Romans d'Isonzo	ITA	Public authority	Local development	
36.	Comune Ronchi dei Legionari	ITA	Public authority	Local development	
37.	Comune Sagrado	ITA	Public authority	Local development	
38.	Comune San Floriano del Collio-Števerjan	ITA	Public authority	Local development	
39.	Comune San Lorenzo Isontino	ITA	Public authority	Local development	
40.	Comune San Pier d'Isonzo	ITA	Public authority	Local development	
41.	Comune Savogna d'Isonzo-Sovodnje ob Soči	ITA	Public authority	Local development	
42.	Comune Staranzano	ITA	Public authority	Local development	
43.	Comune Villesse	ITA	Public authority	Local development	
44.	Comune Buttrio	ITA	Public authority	Local development	
45.	Comune Chiusaforte	ITA	Public authority	Local development	
46.	Comune Cividale del Friuli	ITA	Public authority	Local development	
47.	Comune Corno di Rosazzo	ITA	Public authority	Local development	
48.	Comune Cormons	ITA	Public authority	Local development	
49.	Comune Drenchia	ITA	Public authority	Local development	
50.	Comune Grimacco	ITA	Public authority	Local development	
51.	Comune Lusevera	ITA	Public authority	Local development	
52.	Comune Malborghetto Valbruna	ITA	Public authority	Local development	
53.	Comune Manzano	ITA	Public authority	Local development	
54.	Comune Nimis	ITA	Public authority	Local development	
55.	Comune Pontebba	ITA	Public authority	Local development	
56.	Comune Prepotto	ITA	Public authority	Local development	
57.	Comune Pulfero	ITA	Public authority	Local development	
58.	Comune Resia	ITA	Public authority	Local development	
59.	Comune San Leonardo	ITA	Public authority	Local development	
60.	Comune San Pietro al Natisone	ITA	Public authority	Local development	
61.	Comune Savogna	ITA	Public authority	Local development	
62.	Comune Stregna	ITA	Public authority	Local development	
63.	Comune Taipana	ITA	Public authority	Local development	
64.	Comune Tarvisio	ITA	Public authority	Local development	
65.	Comune Torreano	ITA	Public authority	Local development	
66.	Nomago d.o.o.	SLO	Transport operator	Public passenger bus transport	
67.	Arriva d.o.o.	SLO	Transport operator	International and inter-urban passenger transport by bus	
68.	Ljubljana potniški promet d.o.o.	SLO	Transport operator	Inter-urban and urban passenger transport by bus	
69.	SŽ-Potniški promet, d.o.o.	SLO	Transport operator	International and inter-urban passenger transport by rail	7
70.	Transporto Publico Locale - TPL FVG	ITA	Transport operator	Inter-urban and urban passenger transport by bus	
71.	TREINITALIA	ITA	Transport operator	International and inter-urban passenger transport by rail	
72.	FLIXBUS ITALIA S.R.L.	ITA	Transport operator	International passenger transport by bus	
73.	EGTC Gorica	SLO/ITA	European grouping	Territorial Cooperation	1
74.	Central European	SLO/ITA	International	Support to sustainable	1



Name of Stakeholder	Country	Group	Activity/responsibility	Total
Initiative - CEI		organization	development through cooperation	
SKUPNO ŠTEVILO ZAINTERESIRANIH DELEŽNIKOV				74

9 REFERENCES

- [1] CEI, Ocena teritorialnih potreb za Furlanijo - Julijsko krajino, končni dokument D.T1.2.3, projekt CONNECT2CE, oktober 2017
- [2] Prometni institut Ljubljana, Ocena teritorialnih potreb za Slovenijo, končni dokument D.T1.2.5, projekt CONNECT2CE, oktober 2017
- [3] Sistemi Territoriali, Ocena teritorialnih potreb za DEŽELO BENEČIJO, končni dokument D.T1.2.4, projekt CONNECT2CE, maj 2018
- [4] Komisija EU, GD REGIO, obmejni orientacijski dokument: ITALIJA - SLOVENIJA, Ref. Ares (2019) 3244965 - 17.5.2019
- [5] INTERREG V-A ITALY - SLOVENIA 2014-2020, CCI 2014TC16RFCB036, Revizija 2/2017, odobreno s strani Evropske komisije s Sklepom št. C (2017) 6247, z dne 14. septembra 2017