

D2.1 NAMIRG PERSONNEL TRAINING MANUAL

1 Ship Construction & Stability

1.1 Ship Construction & Terminology (The Hull)

Ship = any “watercraft” carrying passengers or goods equipped with a self-driven propulsion system.

Hull, body = all the external walls and partitions of a ship (*sides, bottom, bulkheads, decks, etc.*) as well as the various connecting structures and reinforcements.

Water plane = the plane joined to the hull and coinciding with the level of calm water in which the ship is immersed.

Water line = the line where the hull of a ship meets the surface of the water.

Ship's bottom, bottom = part of the hull under the water plane, also known as *underwater body*.

Boot top = the area between the water lines of a ship when fully loaded and when unloaded.

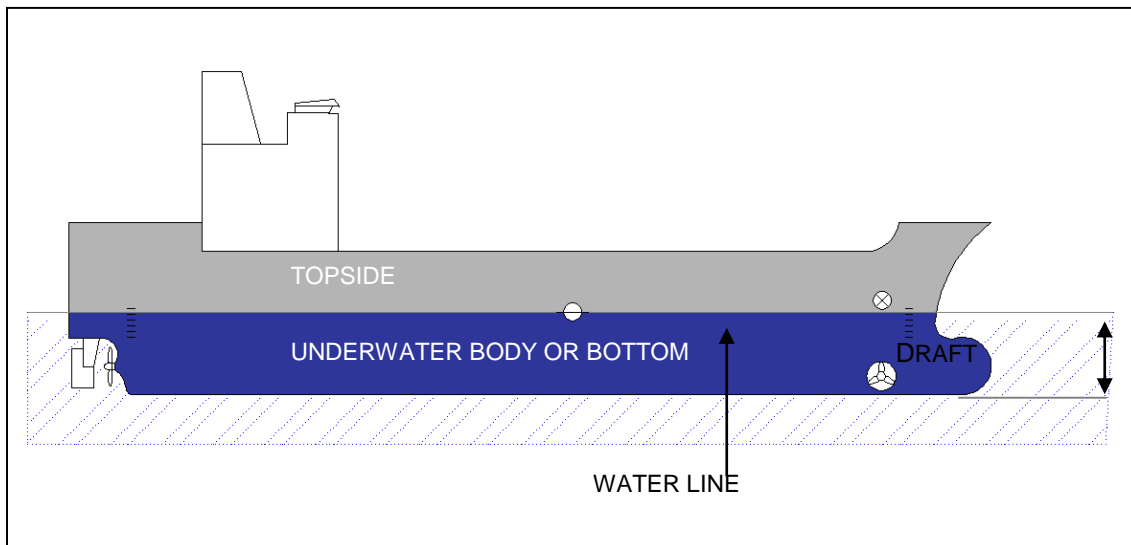

1.2 Terminology and the superstructure/infrastructure

Main deck = The uppermost continuous deck covering all the watertight subdivisions.

Primary deck = the longest external deck.

In a cargo ship, these two decks generally coincide.

Lower decks = The decks beneath the main deck

Upper decks = The decks above the main deck

Platform decks (flats) = small walkable surfaces

Superstructures = All the structures of the ship that are above the primary deck to meet the subdivision requirements, can be either **complete** or **partial**.

Forecastle = Complete superstructure in the sense of width and partial in length extending to the bow.

Quarter-deck = Complete superstructure in the sense of width and partial in length to the stern.

Deck house = *Partial superstructure both in width and length.*

Navigation bridge = Bridge where all the equipment to steer the ship is located.

Midship = The central body of a ship.

Bow = The foremost part of a vessel (*forward*)

Stern = The rear part of a vessel (*aft*)

The body of the ship is generally symmetrical with respect to the **longitudinal plane** which divides it along its length. The two parts are called **starboard** (*the right hand side of the vessel*) and **port** (*the left hand side of the vessel*).

Side (Ship's side) = The outer surface of the hull that extends almost vertically above the water plane.

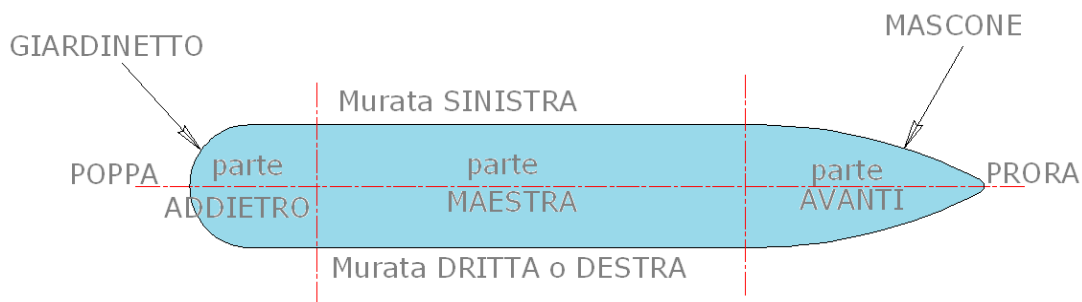

Giardinetto	Stern quarter
Poppa	Stern
Parte addietro	Aft
Parte maestra	Midship section
Parte avanti	Forward
Murata sinistra	Port side
Murata dritta o destra	Starboard side
Mascone	Bow side
Prora	Bow

For the protection of the ship, the following watertight compartments are mandatory:

Collision Bulkhead (*bow*);

Gland Bulkhead (*stern*);

Bulkhead fore of the engines;

Finally, a fourth mandatory bulkhead is envisaged, the bulkhead aft of the engines, if the latter is located towards the ship centre. The two bulkheads arranged aft and forward of the engines, isolate the engines from the rest of the ship.

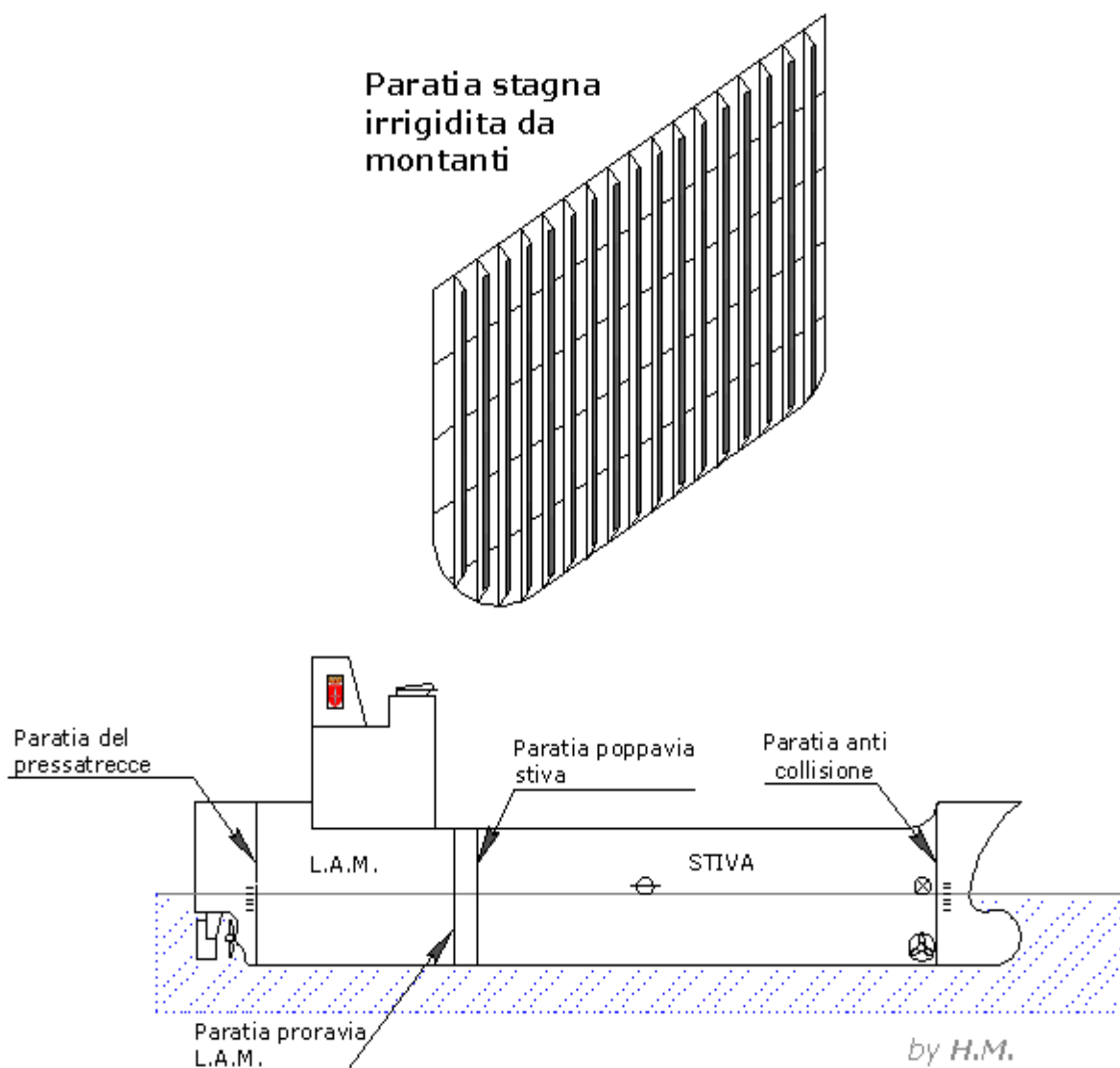

Paratia stagna irrigidita da montanti	Waterproof bulkhead stiffened by uprights
---------------------------------------	---

Paratia del pressatrecce	Gland bulkhead
Paratia poppavia stiva	Hold aft bulkhead
Paratia anti collisione	Collision bulkhead
Stiva	Hold
Paratia proravia L.A.M.	L.A.M. forward bulkhead

The non-continuous lower decks are called **flats**.

The **peaks** are two compartments identified at the extreme bow and at the extreme stern. The **forepeak** and the compartment between the collision bulkhead and the extreme bow, while the **aftpeak** is between the bulkhead of the gland and the extreme stern. Inside the peaks we can find the **trimming tanks**, that are filled or emptied with water to balance the weight of the ship and at the bow there is also the **chain locker**, a room containing the anchor chains.

The **cargo holds** are compartments that are delimited, longitudinally by two transverse bulkheads, below by the bottom or the double bottom of the hull, and at the top by the last bridge

Basic sizes of a ship

Length: distance between the extreme points of the bow and stern;

Width: size of the widest part of the ship;

Height: distance between the keel (*lower plate of the hull*) and the highest point of the superstructures.

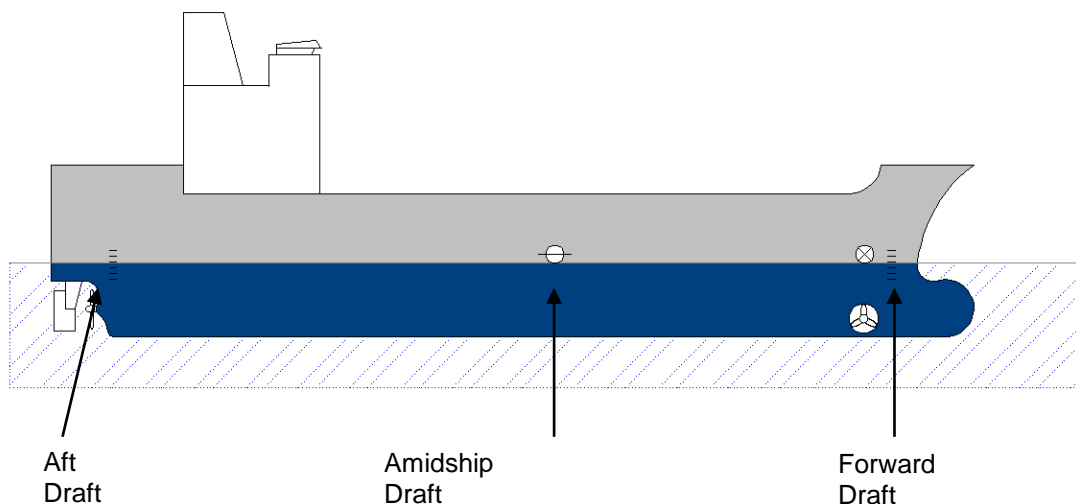

Draft = vertical distance between the water plane and the lower side of the keel. There are three drafts:

- forward draft
- aft draft
- amidship draft

Reserve buoyancy = difference between the volume of the underwater body up to the main deck and the volume of the hull, multiplied by the specific weight of sea water.

Freeboard = vertical distance between the water plane and the freeboard line indicating the position of the **freeboard deck** or the **main deck** which, as we have seen, is the highest **bulkhead deck**. The size is determined according to international regulations and ensures the **reserve buoyancy** of the hull, which is used to compensate for unexpected events.

Displacement = weight of the volume of water displaced by the ship. In balanced conditions this weight is equal to the hydrostatic thrust which is equal to the weight of the vessel.

Capacity = the difference in weight between a fully loaded ship and unloaded ship.

Registered Tonnage = measure of the internal volume of the ship.

1.3 Special Vessel

Ship types

The design features of:

- **Cargo Vessels**
- **Bulk Carriers**
- **Container Vessels**
- **High-Speed Craft**

CARGO VESSELS

Wide variety of cargoes

Designed to be able to visit smaller harbours or rivers

Own means of loading or offloading

"REEFER" Cargo Vessel

A typical Reefer (Refrigerated) banana ship – Note hydraulic cargo cranes on deck





BULK CARRIERS

- Most are larger than general cargo ships
- Generally carry only one type of cargo
- Can be “geared” or “gearless”

Hatch covers

- Cargo vessels, bulk carriers and container ships stow their cargo in holds and the way cargo is loaded and offloaded is through large openings on the main deck, known as hatches.
- To make the holds weathertight at sea, hatch covers form sealed “lids” over the hatches.
- There are three main types of hatch cover:
 - folding
 - side rolling
 - lift off pontoons

The following is an example of side rolling hatch covers – normally hydraulically operated and used on the majority of gearless bulk carriers.



Folding hatches

An example of folding type hatch covers is shown below- normally they are opened and closed by wires pulled by the ship's own cranes or derricks; they are often found on smaller general cargo vessels and geared bulk carriers.



Pontoon hatch covers

An example of a large pontoon type hatch cover being lifted off by a shore crane. This type of cover is generally found on large gearless container ships

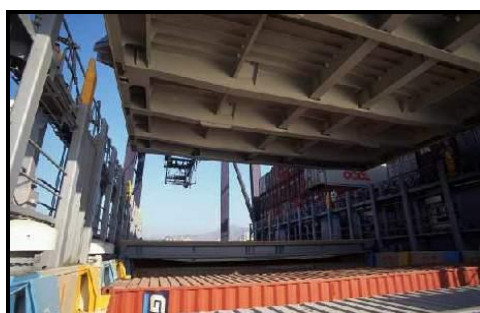

CONTAINER VESSELS

Container ships generally have a high freeboard and a high superstructure
Containers are stowed deep in cells within holds and are lowered and raised via special guides, this allows for accurate and speedy loading/offloading by shore cranes.



The following features may affect firefighter safety on cargo and container ships:

- Types of cargo
- Limited access and egress within holds
- Limited space on deck (fully laden container ships)
- Confined spaces
- Risk of falling from a height within cargo holds
- Free surface effect (firefighting water within holds etc.) *(Please refer to chapter 1.6 for detailed information)*

HIGH-SPEED CRAFT

- The primary function of a High-Speed Craft is passenger transportation.
- Some larger vessels carry both passengers and vehicles
- As the name suggests, high-speed crafts can achieve far greater speeds than conventional ferries (up to 40 knots)
- Specific regulations under Safety of Life at Sea (SOLAS) Convention



- Public areas on one or two decks (large open areas)
- Up to 1500 passengers and 400 cars
- Restaurants, bars and seating areas
- Crew accommodation is very limited (small compartments)
- Difficulty of access to machinery spaces
- Limited areas for helicopter winching

Firefighter safety

The following features may affect firefighter safety on a high-speed craft:

- Aluminium construction (alloy with a low melting point)
- Limited access and egress (evacuation systems)
- Confined spaces (especially in machinery areas)
- Risks from commercial vehicles (e.g. HAZMAT loads)

TANKERS AND PRODUCT CARRIERS

Tankers carry bulk liquids in tanks.

The type of cargo carried by tankers varies from crude oil, fuel oils, petroleum spirit and aviation fuels to coconut oil, rape seed and other vegetable oils.

Tankers carrying a variety of refined liquids are known as “Product Tankers” or “Product Carriers” and will either carry one type of cargo or a variety of different cargoes in different tanks. Each product is known as a “parcel”.



Crude Oil tankers carry huge quantities of cargo and range in size from 30,000 tonnes up to 1/2 million tonnes (deadweight)

Tankers in the range of 100,000 to 300,000 tonnes are known as VLCCs (Very Large Crude Carriers)

Tankers in the range of 300,000 to 500,000 tonnes (and above!) are known as ULCCs (Ultra Large Crude Carriers)

VLCCs and ULCCs can reach up to 500 m in length.

CHEMICAL & GAS TANKERS

Gas Carriers (Tankers):

- LNG (Liquefied Natural Gas)
- LPG (Liquefied Petroleum Gas)



LPG (propane) and Natural Gas (methane) are both used in essentially the same way but are nevertheless different in many ways.

LPG (propane) and natural gas (methane) have different chemical formulas: Methane is CH_4 , whereas propane is C_3H_8 .

LPG has a higher calorific value - that is, energy content - than natural gas, with $93.2MJ/m^3$ vs. $38.7MJ/m^3$.

For proper combustion, LPG requires an air to gas ratio of approximately 25:1 whilst natural gas requires a 10:1 ratio.

LPG

LPG (propane) is denser than air, at a relative density of 1.5219:1 vs. natural gas (methane) at 0.5537:1, which is lighter than air.

LPG can be compressed into a liquid and stored or transported in a cylinder or larger vessel.

Natural gas and LPG appliances operate at different pressures.

The term LPG actually encompasses more than one type of gas.

There are a number of hydrocarbon gases that fall into the category of LPG.

Their common characteristic is that they can be compressed into a liquid at relatively low pressures.

The two most common are Propane and Butane.

LNG

Methane gas is processed into LNG by cooling it to $-161^{\circ}C$, at which point it becomes a liquid.

This reduces the volume of the natural gas by a factor of more than 600 times as it goes from its gaseous state to a liquid.

That's like going from a beach ball to a ping pong ball.

This reduced volume facilitates economical transport by sea or road.

Common LNG uses include industrial applications and long haul trucking.

Chemical Tankers

Chemical tankers are required to transport a wide range of different cargoes, and many tankers are designed to carry a large number of segregated products simultaneously. The operation of chemical tankers differs from any other bulk liquid transportation operations, in that on a single voyage a large number of cargoes with different properties, characteristics and inherent hazards may be carried.

Moreover, in port several products may be handled simultaneously at one berth, typically including different operations such as offloading and loading as well as tank cleaning. Even the less sophisticated chemical tankers are more complex to operate than oil tankers. Transportation of bulk chemicals by sea not only requires specialist ships and equipment, but also specialist crew training, both theoretical and practical, so that those involved understand the characteristics of the various chemicals and are aware of the potential hazards involved in handling them. A particularly important aspect of this requirement is the provision of a data sheet, or cargo information form, giving details that are specific to a substance, to be kept on board whenever that substance is carried by the ship.

A modern chemical tanker is primarily designed to carry some of the several hundred hazardous products now covered by the IMO Bulk Chemical Codes. The following general types of chemical carriers have developed since the trade began:

Sophisticated parcel chemical tankers:

Typically up to 40,000 tonnes deadweight with multiple small cargo tanks - up to 54 - each with an individual pump and a dedicated pipeline to carry small parcels of high-grade chemicals. A significant proportion of the cargo tanks in these ships are made of stainless steel, allowing maximum flexibility to carry cargoes that need their quality safeguarded.

Product/chemical tankers:

Of a similar size to parcel tankers but with fewer cargo tanks, mostly made of coated steel rather than stainless steel, and less sophisticated pump and line arrangements. Such ships carry the less complex chemicals, and also trade extensively with clean oil products.

Specialised chemical carriers:

Small to medium sized ships, often used for dedicated trades and usually carrying a single cargo such as an acid, molten sulphur, molten phosphorus, methanol, fruit juice, palm oil and wine. Cargo tanks are coated or in stainless steel according to the type of trade.



PASSENGER VESSELS

Cruise Liners

Modern passenger ships can transport anything up to 9,000 people, creating the most deeply-felt security problem in the world, that is, Mass Rescue Operations, or rescue operations that cannot be managed with rescue means that are normally available.

For this reason, the rescue philosophy, especially for this type of ship, is the return of the ship to a safe harbour, avoiding that it is abandoned in the middle of the sea, with all the associated risks.

RO-RO and RO-RO Pax

The ferries (or Ro-Ro, i.e. Roll-on/Roll-off) are ships equipped with loading ramps that can load and offload complete vehicles.

They can only be used to transport goods and vehicles or they can also operate a passenger ferry service (Ro-Ro Pax), which in fact is statistically the most accident-prone type of ship due to the presence of cargo that is not easily controlled, such as cars and trucks and passengers, who are even less controllable.

1.4 Fire Protection - Passive

“Technical” passive protection measures:

- escape routes
- internal structures subdivided by resistant bulkheads (*metal partitions*) made of steel and other moderate fire-resistant materials, divided into:

CLASS “A” BULKHEADS AND DOORS must be constructed of steel or equivalent material; suitably stiffened and so constructed as to be capable of preventing the passage of smoke and flame from one area to another for 1 hour; and so insulated where necessary

with approved materials that the average temperature if the division is exposed to a standard fire test (of 60 minutes), shall not exceed 139°C.

CLASS "B" BULKHEADS AND DOORS must be capable of preventing the passage of flames to the end of the first 30 minutes and be insulated with flame retardant materials as per class "A" bulkheads.

CLASS "C" BULKHEADS AND DOORS must be constructed of suitable non-combustible materials that do not burn nor give off inflammable vapours up to a temperature of 750°C.

1.5 Fire protection – Active

"Technical" active protection measures:

- life-saving equipment
- evacuation slide systems
- portable devices as a first approach (hand-held and wheeled fire extinguishers)
- fixed protection installations (fire hydrants, fire detection and alarm systems and automatic shutdown systems)

ON-BOARD FIREFIGHTING SYSTEMS

Hydrants plant

Water is still the most commonly used agent to extinguish most fires. Each ship must, therefore, be equipped with a fire water network that is capable of supplying sufficient pressure at all times.

The basic features of a fire water network on board a ship are:

- utmost reliability
- user-friendly

The fire water network must be used for this purpose only.

Fire hydrants are fitted in suitable positions along the entire system, where one or more flexible pipes with lances connected at the end.

Other typically maritime models allow the possibility of mounting a rigid curved extension at the end. The dispensing nozzles which they are equipped with create a mist to fight fires in places where it is difficult to enter due to high temperatures; therefore, it is possible to start the cooling action from the outside without excessive risks to the operators.

The fire extinguishing system is always under pressure and ready for use.

In the case of an accidental event, the fire extinguishing system may get damaged with possible pipe breakage. To make sure that the integral part of the system can still function, sectioning valves are installed so that the damaged sections of the plant can be excluded.



There are various types of hose/lance, hose/hydrant fittings, etc., that are either screw or quick couplings, depending on the ship building regulations.

International connection

Large vessels must be equipped with an **international connection** of a standard size, which is used to connect the fire system to an external water supply.

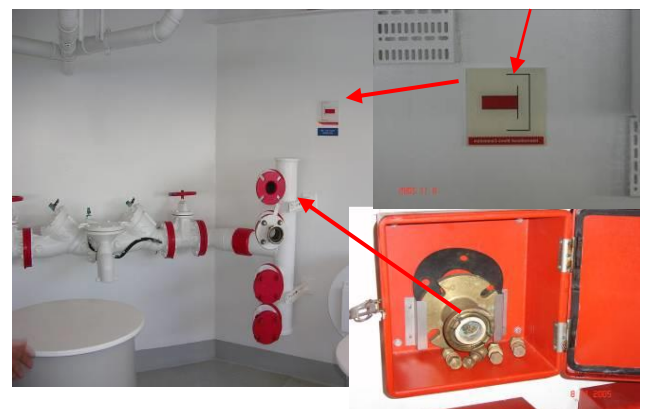
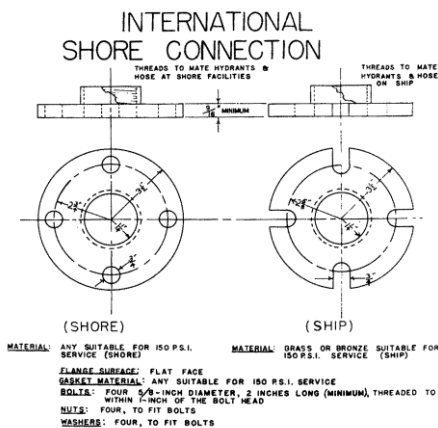

CO₂ systems

Total saturation systems make it possible to reach and maintain the concentration of extinguishing agent – in our case, carbon dioxide - in a confined space to put the fire out.

CO₂ systems work by suffocation, i.e they dilute oxygen below the minimum percentages for combustion.

The residual amount of oxygen in an environment saturated with CO₂ is absolutely inadequate for human survival.

Access to areas protected in this way has appropriate signage affixed to warn of the potential danger, often illustrating the emergency procedures to be followed.

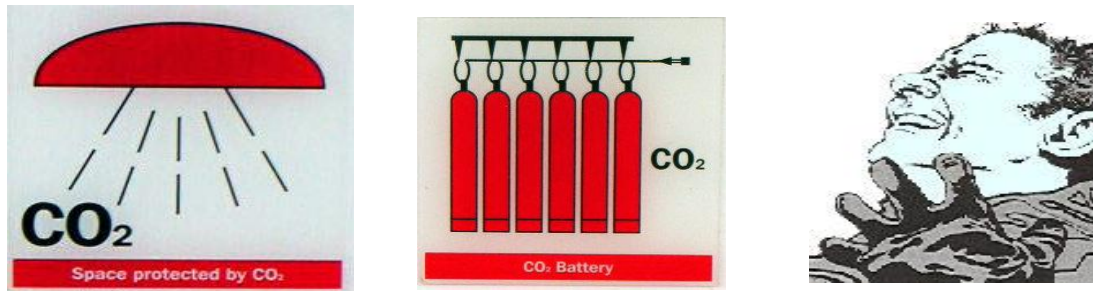

These systems are designed according to the event that assumes:

- Surface fires: involving flammable liquids, gases and solids. Extinguishment must be quick by introducing a gas concentration proportional to the type of material ignited into the enclosed space.
- Three-dimensional fires: involving combustible materials that are stored, installed, or being processed and which develop three-dimensionally. Extinguishment is achieved by maintaining a CO₂ concentration in the protected room for a sufficient period of time, so that the embers are extinguished and the material cools to prevent re-ignition

only the commander can give the order to use the system!

To be effective, the discharge time must be quick (within 2 minutes) and it can cause an overpressure in the protected areas.

The saturation system is very effective but the inert atmosphere must remain in the rooms for a long time, so if the functionality of the rooms is vital for the ship's safety (e.g. engine room), the system must be used as a last resort.

The system can only discharge once, therefore, it is important to make sure that any openings in the room are closed beforehand, otherwise the discharge will be ineffective.

When several rooms on a ship are protected by CO₂ systems the cylinder battery of another circuit can be used to make a second discharge in the room affected by the fire, using suitable connections between the manifolds or flying connections.

After the attack, before allowing unprotected operators to enter the area, the room concerned must be ventilated adequately with natural or forced ventilation systems, bearing in mind that the concentration of CO₂ will be highest in low areas.

Local systems

There are local CO₂, powder and foam firefighting systems, which are half way between a fixed firefighting system and a portable device, designed for individual areas.



Portable foam devices



Considering that the amount of foaming agent is about 20 l, this appliance can produce a volume of foam equal to about 6 m³ (1 m³ covers an area of about 12/15 m²).

Kitchen protection systems

Among the areas of a ship that are at a high risk of fire are the kitchens, especially the following:

- Cooking area: burners, deep fryers, ovens
- Extractor hoods and filters
- Steam extraction duct

Burner fires are easy to put out as they are in open and easily accessible spaces. Fires in ducts are far more dangerous, as the fire may appear to have been extinguished but as it is not visible it could have extended to affect the upper compartments.

For this reason, cooking appliances are protected by dedicated fire-fighting systems.

A steam extinction system is also often used, which only protects the hoods and the related ventilation ducts. The operating principle is relatively simple: the dampers on the hoods are closed and the system valve is opened to flood the hoods and ducts with steam, extinguishing the fire by suffocation.

Currently, manual and automatic protection systems that are controlled by temperature sensors installed on cooking appliances, are also produced. The equipment consists of a

tank containing the extinguishing agent, a pressurization system, a series of pipes and nozzles that discharge both on the cooking surface, inside the hood and in the extraction ducts.

The extinguishing agent used is a potassium-based solution which, in addition to cooling, reacts with hot grease to form a layer of foam by saponification that acts as an insulator between the fat itself and the atmosphere.

The extractors on burning cooking appliances should be left running to help the extinguishing agent rise in the ducts, while all the others must be switched off.

Nevertheless, the extinguishing systems are efficient even if the extractors are not working.

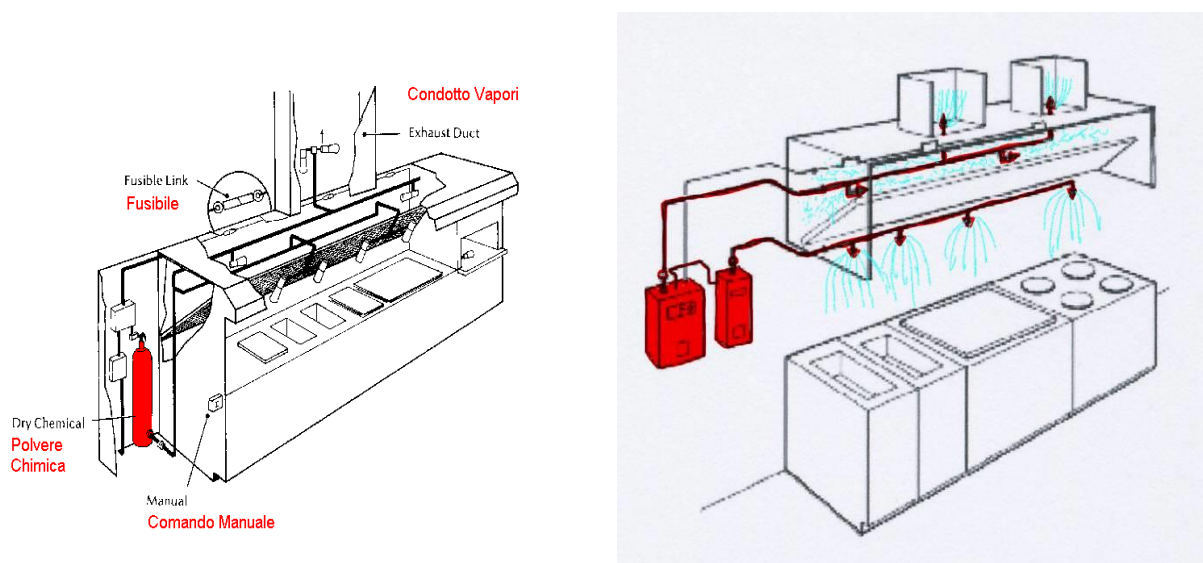

1.6 Stability

Vessels float in the water thanks to the thrust that they receive, as the principle of Archimedes says that any body completely or partially submerged in a fluid at rest is acted upon by an upward or buoyant force, the magnitude of which is equal to the weight of the fluid displaced by the body.

Vessels are subject to two forces, weight P , which is considered to be applied at the centre of gravity, point G , and the hydrostatic or Archimedes' upthrust (buoyancy) S , applied at the centre of the hull, point C .

In a stable equilibrium the two forces act along the same vertical line and are the same but in opposite directions.

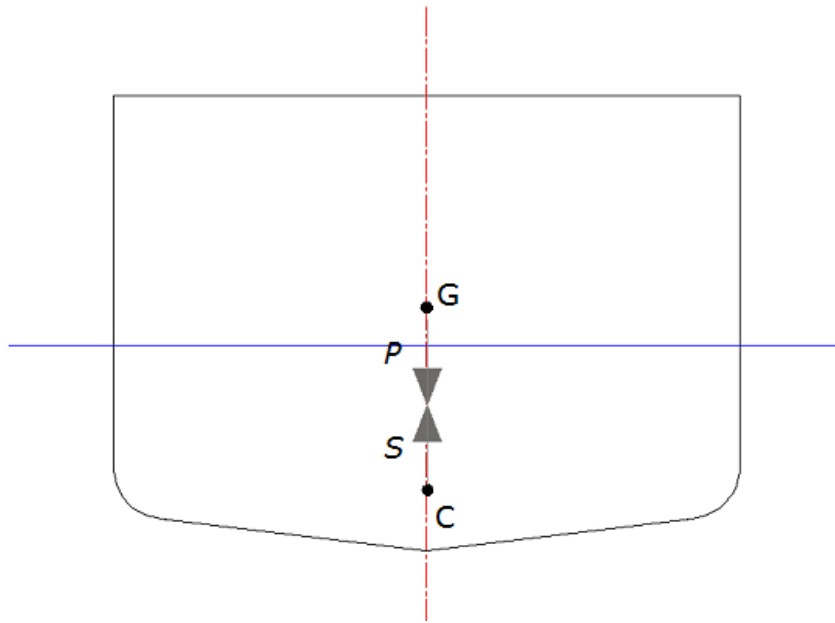

However, the ship is subject to external forces such as the sea and the wind that cause it to roll (*tilt*).

Assuming that the weights do not change or move, G remains stationary while S moves because the hull varies.

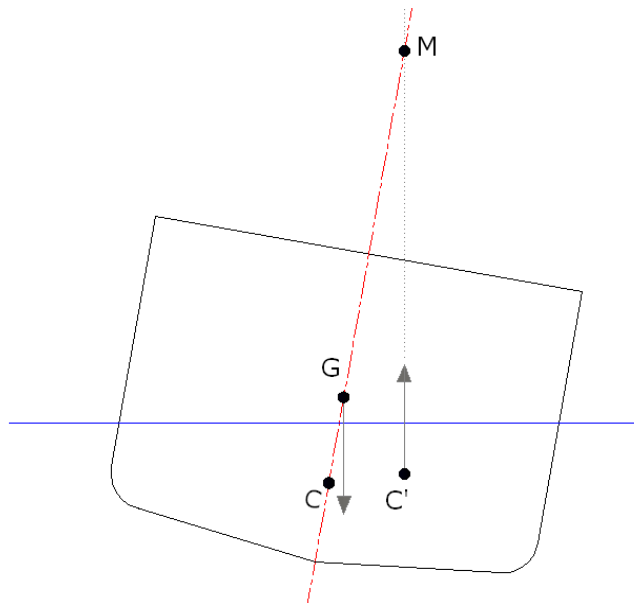

Normally, the moment created by weight P and buoyancy S tends to bring the ship back to its original upright position. **Stability** is therefore the tendency of a hull to resume its equilibrium.

An exceptional situation is when there is a load shift, or part of a load. When the ship tilts and the weight shifts, the centre of buoyancy S and the centre of gravity G move as a consequence, creating a new position of equilibrium with the ship **heeling**. It is evident that this new situation has a limited ability to restore equilibrium and is particularly dangerous in adverse weather conditions.

The distance between point G and point M (transverse metacentre), where the buoyancy line intersects with the ship's line of symmetry, gives an indication of its stability.

The greater the distance $G-M$, the more stable the ship and the quicker its ability to straighten up; the ship is then said to be **hard**.

The smaller the distance $G-M$, the less stable the ship and the slower its ability to straighten; the ship is then said to be **soft**.

The latter situation is typical of passenger ships where part of the stability is compromised to give more comfort.

The limit is given by the negative value of this distance, with point M below point G , consequently creating a tilting moment.

This condition can also occur when additional weights are loaded at the top, as point G moves in this direction until it is above point M .

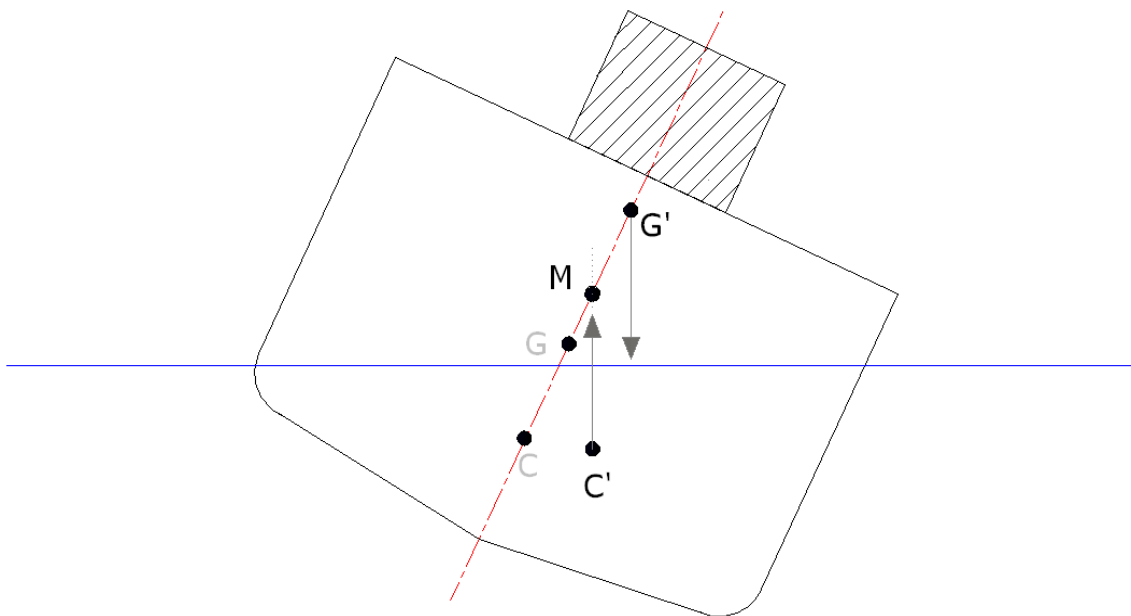

Another case in which a heeling moment is created is when an additional weight is loaded in a side position, since in this condition point G shifts from the ship's symmetrical line.

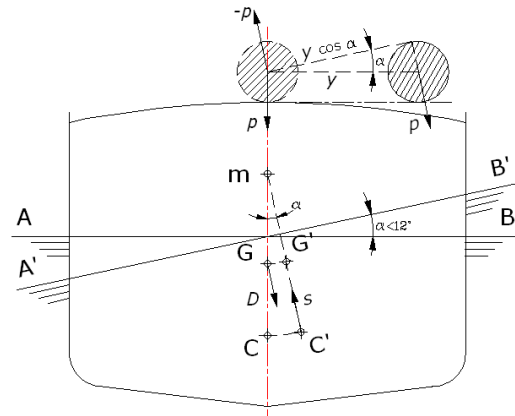

Liquid cargoes are extremely dangerous for ships, and above all the **free surface effect** of such liquids. When referring to the free surface effect, the condition of a tank that is not full is described as a "slack tank", whereby the liquid is free to build up on the side towards which the ship has tilted, emphasising the inclination.

The most recent accidents, loss of the *MS Herald of Free Enterprise* and *MS Estonia*, were caused by the free surface of water that accidentally surged in from the hold door.

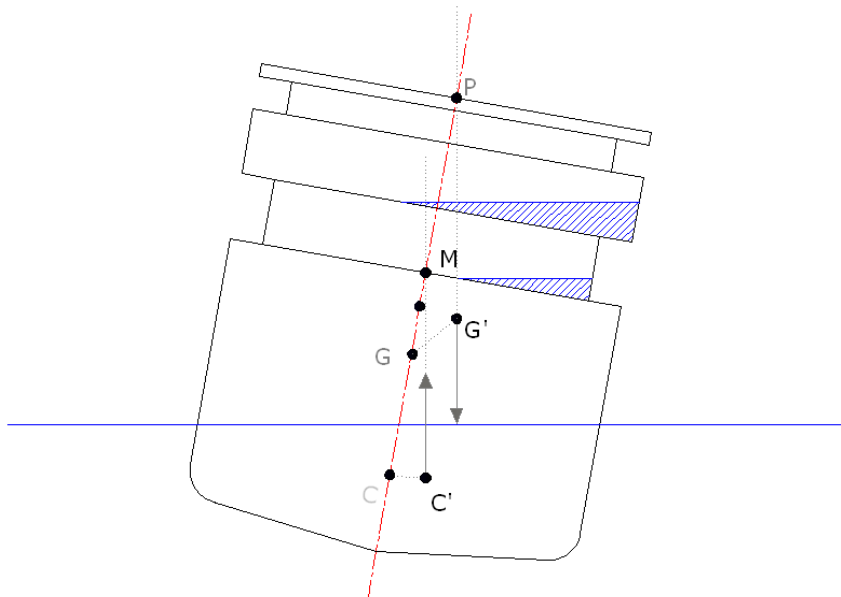

Very often, firefighting operations that have lasted for days on board large ships, have ended up in capsizing and sinking the vessel due to the extinguishing water used. Therefore, it is necessary to limit the use of water and/or provide for its outboard disposal, especially when operating on the higher decks. If this were not possible it could be useful to "move" this water in the bilges (*closed compartments in the bottom of the hull of the ship*), both to reduce the free surface by confining it to smaller compartments and to lower the centre of gravity G, consequently increasing the stability. Another method to lower the risk is to adopt systems that use limited or zero quantities of water to put out a fire (foam, hi-fog, CO₂, etc.).

1.7 Load lines and tonnages

Draft: The depth of a ship's keel below the **water plane**. Since this is not constant between the two ends, there are two drafts: a **forward draft** and an **aft draft**. The difference between the aft and forward draft in almost all the ships is called the **trim**.

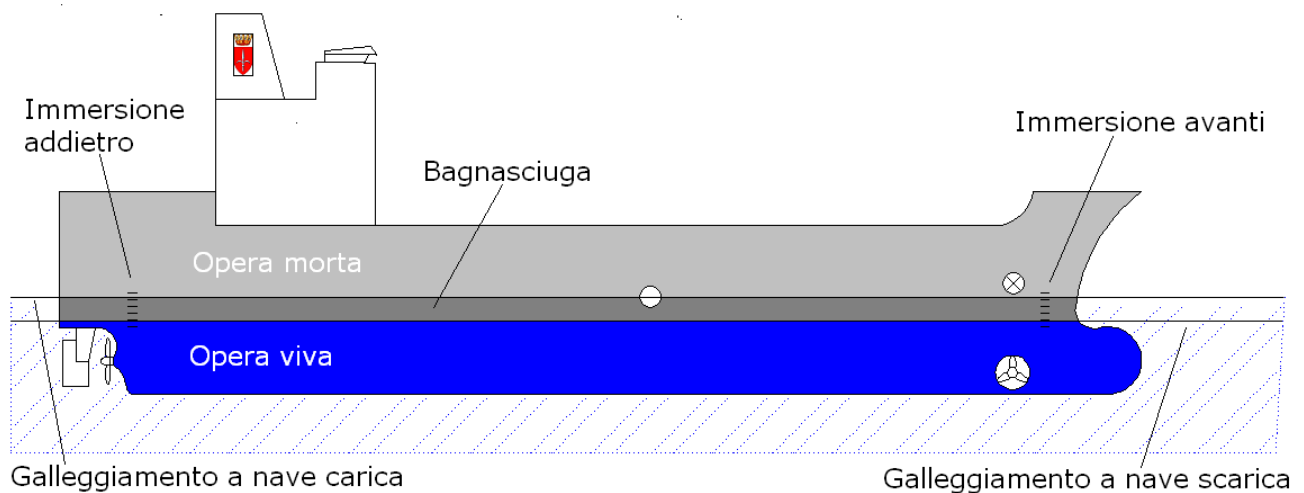

Immersione addietro	Aft draft
Immersione avanti	Forward draft
Bagnasciuga	Boot-top
Opera morta	Topside
Opera viva	Underbody
Galleggiamento a nave carica	Waterline with loaded ship
Galleggiamento a nave scarica	Waterline with empty ship

The arithmetic mean of the two drafts is known as the **mean draft from bottom of keel**.

The draft is marked as a graduated scale on a ship's bow, stern and sometimes even in the middle. If the metric system is used, the scale is represented by Arabic numerals. If, on the other hand, English feet (Imperial units) are used, the scale is shown in Roman numerals.

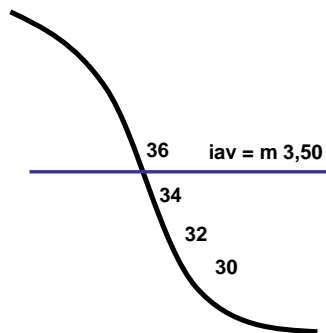

RUOTA DI PRORA

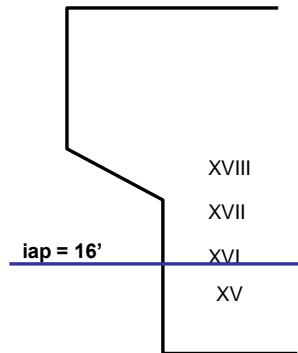

DRITTO DI POPPA

STEMPOST

STERNPOST

The longitudinal trim of a ship is its longitudinal position due to the particular arrangement of the loads. To check the trim on all ships, the drafts on the scale at the bow, in the centre and at the stern are read.

With the metric system each mark is one decimetre high; there are still ships that use the English (Imperial) system, in which the markings are 1 foot high.

Only even numbers are marked; the zero of a scale relates to the false keel draft if this represents the part of the hull that drafts more.

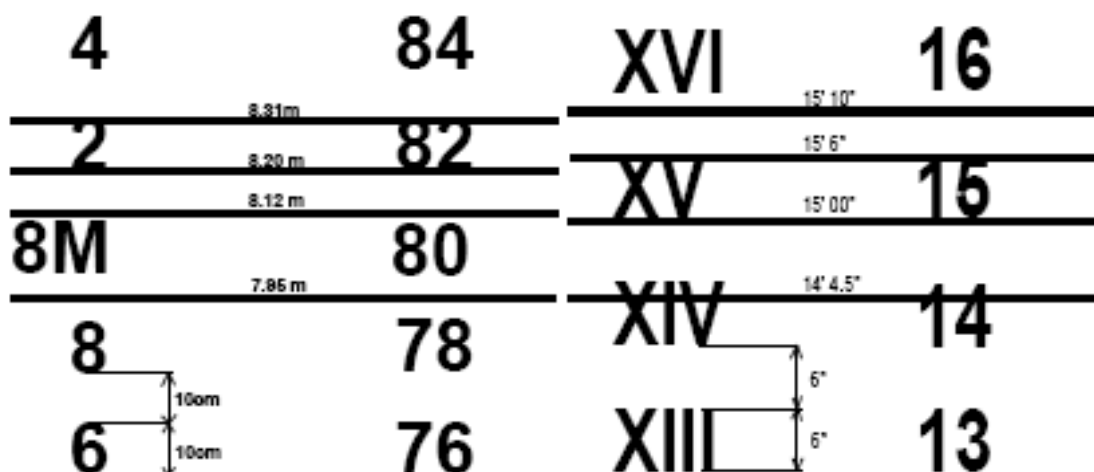

FREEBOARD

The **freeboard deck** is considered the highest continuous watertight deck, that is, where the exposed openings have a permanent watertight closure. Generally it coincides with the main deck. To calculate the freeboard, ships are classified in:

Type A: ships designed to transport bulk cargoes in which the cargo tanks have only small access openings, closed by hatches that are made of steel or equivalent material, with watertight seals.

Type B: all ships not having the characteristics of type A.

Freeboard; the freeboard of a ship is the vertical distance between a horizontal line traced halfway along the ship, at the intersection of the planking side of the highest continuous watertight deck (freeboard deck), and the waterline corresponding to the maximum load (maximum load line) that the ship itself is authorised to embark in relation to the characteristics of the journey that it is about to make.

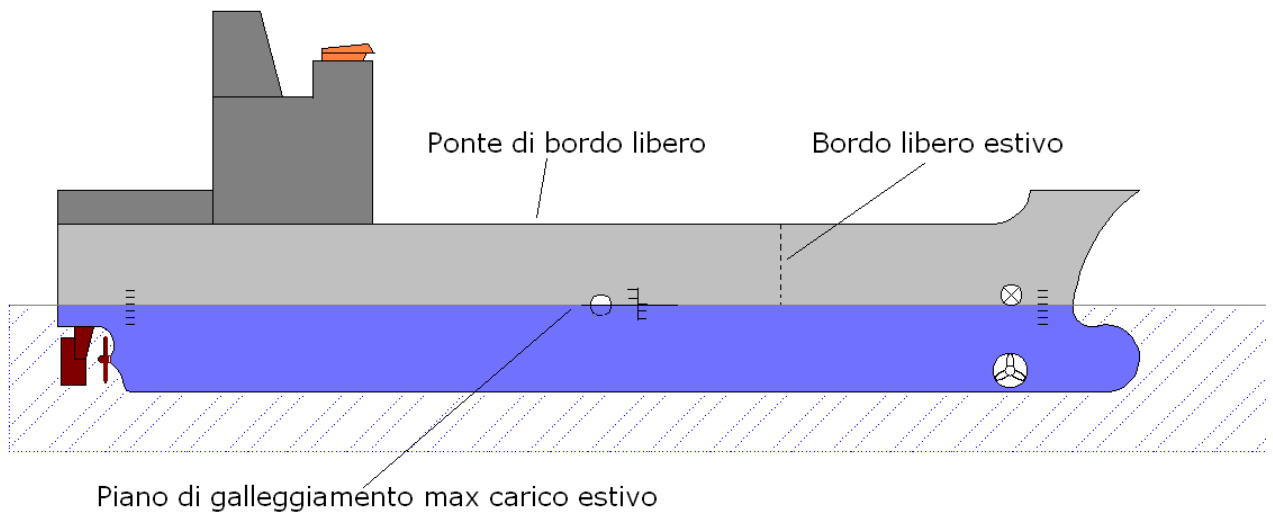

Ponte di bordo libero	Freeboard deck
Bordo libero estivo	Summer freeboard
Piano di galleggiamento max. carico estivo	Water line max. summer load

Volume of displacement V, is the immersed volume of a ship's hull.

DISPLACEMENT

Displacement D: displacement of a ship is its weight, expressed in tonnes.

$$D = P$$

The displacement can always be calculated using Archimedes' principle which states that: the upward buoyant force that is exerted on a body immersed in a fluid is equal to the weight of the fluid that the body displaces and acts in the upward direction:

$$S = \gamma \times V = P$$

Where:

S = Buoyancy

γ = specific weight of the shifted liquid (t/m³);

V = volume of the shifted liquid or volume of displacement (m³);

Hence, under conditions of static equilibrium (zero accelerations), the **buoyancy** equals the ship's weight (structure + load) free to float.

As the average specific weight of sea water $\gamma = 1.026$ tons/m³ the displacement value will be:

$$D \text{ (ton)} = \gamma \times V = 1.026 \text{ (ton/m}^3\text{)} \times V \text{ (m}^3\text{)}$$

The English express the displacement in Long Tons, with 1 Long Tons = 1,016.048 kg.

With the shipbuilding plans available, it is always possible to calculate the volume of displacement.

PAYLOAD AND TONNAGE



Payload: The payload is an index of the ship's load capacity and therefore of the weight it can carry, i.e. deadweight and netweight:

- a) **deadweight** is how much weight a ship can carry, not its weight, empty or in any degree of load. Deadweight is the sum of the weights of cargo, passengers, crew, fuel, lubricants, provisions and water.
- b) **netweight** is the weight of cargo and passengers only.

Tonnage is a measure of the volume of a ship. It is expressed in register tons, each of which is equal to 100 ft³, or 2.832 m³). The tonnage of a ship, that is the calculation of its commercial tonnage, has direct influence on the economy of the ship and on the legal and commercial laws and regulations. Like the payload, tonnage is also defined as follows:

- a) **gross tonnage** is a function of the volume of all enclosed spaces of a ship or spaces that can be enclosed. It is used to define the limitations and thresholds to building or manning ships according to professional title; owner and builder fees and insurance premiums are regulated; fees are fixed for visits by the surveyors of classification registers, those for the use of dry docks, etc;
- b) **net tonnage** is based on a calculation of the volume of all cargo spaces. It indicates a vessel's earning space and is obtained by subtracting the volume of spaces for the crew, the ship's services, and motor room from the gross tonnage.

To be noted is that military vessels are also subject to payment of transit rights in channels on the basis of net tonnage.

The tonnage deck (essential for calculating the tonnage) is the second continuous deck from the bottom, in ships with a single continuous deck, which will also be the tonnage deck. To calculate the tonnage, three rules are applied: with or without bridge and with full holds.

N.B. Normally only the displacement is shown on R.I.N.A. (Registro Italiano Navale - Italian Register of Shipping) certificates for military vessels and for Firefighting vessels, and not the tonnage.

Buoyancy reserve is the difference between full load displacement and empty ship displacement.

Where:

W is the volume of displacement and Vc is the immersed volume of a ship's hull therefore, the buoyancy reserve will be:

$$R = \gamma \times W - \gamma \times Vc$$

that is:

$$R = \gamma (W - Vc)$$

γ being the specific weight (expressed in ton/m³) of sea water.

2 SAR

Vessel Triage

Vessel TRIAGE is a method proposal, drafted in international cooperation, for the assessment of the safety status of vessels in maritime accidents and incidents. The method is intended to facilitate and enhance effective communications concerning the safety status of vessels. The method is intended for use by both vessels and maritime emergency responders to assess whether the subject vessel can provide a safe environment for the people aboard. The method is used to form a rough understanding of the nature of the incident or accident and thereby determine the safety status of the vessel. The method is applied on a ship-by-ship basis. That is, when several vessels are involved in an accident, the safety status of each is evaluated separately. The primary purpose of the method is to enhance effective communications between the vessel(s) involved and maritime emergency responders as well as support related situational assessment and decision-making.

The method expresses the safety status of the vessel in terms of a Vessel TRIAGE category. There are four categories: GREEN, YELLOW, RED and BLACK.

- **Green:** Vessel is safe and can be assumed to remain so
- **Yellow:** Vessel is currently safe, but there is a risk that the situation will get worse
- **Red:** Level of safety has significantly worsened or will worsen and external actions are required to ensure the safety of the people aboard
- **Black:** Vessel is no longer safe and has been lost

The application of the method has four stages. In the first stage, the vessel status is examined in terms of the threat factors defined in the method (e.g. flooding, decrease of manoeuvrability). The next steps are to assess the severity of the materialised threat factors (stage 2) and the effects of crew capabilities and weather conditions (stage 3). Finally, the Vessel TRIAGE category describing the safety status of the vessel is determined (stage 4).

These stages may be repeated as necessary during the accident, depending on the duration of the situation. Changes in the threat factors and their severity and in the Vessel TRIAGE

category indicate how the situation is evolving and thus provide important information for all participants.

The Vessel TRIAGE method determines the vessel's safety status on the basis of the evaluated severity of materialised threat factors.

The Vessel TRIAGE method defines a "threat factor" as an event/consequence caused by an incident or accident to a vessel that might adversely affect vessel's safety. The threat factors included in the method are:

- Flooding
- Listing, decrease of stability
- Decrease of manoeuvrability
- Black-out
- Fire, explosion
- Danger posed by hazardous substances

The first three threat factors concern the decrease or loss of fundamental safety characteristics – buoyancy, stability and manoeuvrability. The fourth factor concerns the loss of technical/operational functionalities aboard the vessel. The last two threat factors are more linked to the potential consequences of any substances or materials carried on the vessel (e.g. cargo, goods, etc.).

These threat factors are not necessarily independent of each other.

In other words, the existence of one threat factor may lead to the materialisation of another. For instance, flooding can result in the decrease of vessel stability, and a black-out can compromise manoeuvrability. However, the factors are not always interlinked. For instance, listing/decrease of stability is not always related to flooding, but could instead be the outcome of ice formation on ship superstructures or the shifting of cargo.

The use of the Vessel TRIAGE method provides an understanding of the vessel's safety status, which is expressed in terms of a Vessel TRIAGE category. The Vessel TRIAGE category indicates the level of safety for persons aboard a vessel, taking into account the prevailing and anticipated conditions on the vessel and in its environment.

Of the adjacent categories, in principle the most significant difference in vessel's safety status is between the yellow and red categories: In the yellow category (as in the green, of course), it is still safe for people to remain aboard the vessel, whereas in the red category, their safety is severely threatened, either immediately or in the foreseeable future. In the black category, the vessel no longer provides any safety.

The method has four stages. These are:

- 1) identifying the threat factors that have materialised
- 2) evaluating the severity of materialised threat factors
- 3) evaluating the effects of crew capabilities and weather conditions
- 4) determining the Vessel TRIAGE category

Stages 1, 2 and 4 are of key importance in assessing the safety status of a vessel. Stage 3 is different in nature, but serves to facilitate accurate situational awareness.

Even though the method provides general descriptions of operational focuses for different Vessel TRIAGE categories, the method is not intended to replace the existing accident management procedures used by vessels and maritime SAR authorities. Vessel TRIAGE supplements these procedures by introducing a new dimension to accident management in order to support situational assessment, decision-making and communications

3 Communications

Organising effective communications between the MRCC/MRSC, distress vessel (DV) and rescue units is an integral part of rescue operations.

It is responsibility of the SAR authority coordinating communications, so MRCC/MRSC drafts a communications diagram for the incident in question and states which communications channels are to be used.

In communications during a vessel fire operation, it must be ensured that all rescue operation-related communications from the incident area go through the coordinating MRCC/MRSC before being relayed to other actors.

The rescue units must not bypass the MRCC/MRSC when reporting on their operations, otherwise, the MRCC/MRSC's coordination-related situational awareness and decision-making may be based on incomplete information.

Other authorities may turn to the MRCC/MRSC for information about the current situation or they might station a representative of their own at the MRCC/MRSC to maintain contact with their organisation.

The exception to that is the distress vessel communications with its own shipping company, commercial tugs, interest organisations (e.g. insurance company) or experts but, if those communications shed light on information that has a bearing on the rescue

operation or people's safety, the master of the vessel is obligated to inform the MRCC/MRSC about them.

COMMUNICATIONS TOOLS

There are various levels of communication during a complex operation such as a fire at sea.

The first communication will certainly be the distress vessel's (DV) request for assistance. The vessel's primary means of communications is Maritime VHF. In addition the vessel can use MF-HF radio, satellite phone, GSM or Inmarsat C. In long-distance communications, such as when outside the VHF range, it may be necessary to use MF-HF frequencies or air/surface craft to relay communications.

Let us consider the use of telephony through channel 16 of maritime VHF; a channel dedicated to sea rescue, or of the automatic call on channel 86 for data transmission (DSC Digital Selective Calling). This communication can be picked-up from ships in the area and/or from the MRCC (Maritime Search and Rescue Coordination Centre) contact for the Search and Rescue Region (SRR) in which the DV is located.

The main communications tools used by the MRCC/MRSC and rescue units are Maritime VHF radios, GSM, satellite phones and other technical devices that are suitable for transmitting situation reports and electronic messages (email, certain surveillance devices, fax, etc.).

Assuming that after the emergency has been established, the competent MRCC continues radio communications with the DV and, in case, with the ships in the area, which may also be rerouted to the accident site to provide assistance, if necessary.

The MRCC will then also alert the land-based intervention teams, if need be, using the means of communication considered most appropriate among those at its disposal.

Once the rescue teams (MIRG) have left, communications will take place between the MRCC, the rescue team carrier and the DV via radio, while communications between the MRCC and the various bodies participating in the rescue operations, may take place with other systems as well. A multi-agency emergency coordination centre can also be set up at MRCC to simplify communications and reduce decision-making time.

When rescue teams reach the DV they will communicate at a local level via radio, preferably UHF for the best transmission within the ship's structure, between the operating teams and the Group Leader and between the Group Leader and the Operations Commander, located at the command point together with the ship's Master.

From an operational point of view, constant feedback from the operating teams to the GL is essential and from the GL to the OC so that both can evaluate the strategy implemented.

The ship's master and the OC will maintain a second level of communication, via maritime VHF radio or other appropriate means, with the OSC, if present, or directly with the MRCC, on the work channel decided thereby.

The On-Scene Coordinator (OSC), if present on site, will coordinate operations locally, as outlined by the SMC, coordinating communications, evaluating the actions undertaken, keeping the SMC updated, requesting or releasing resources according to how the situation is evolving.

At this point the MRCC will implement a third level of communications with all the units involved in the emergency, either directly through their representative at the emergency coordination centre, or using the most suitable means of communication, to keep them informed about the development of operations, to request any additional resources, etc

As we have already seen for the operational communications of the NAMIRG team, it is very important that there is a constant update of the operations on the DV by the ship's master and the OC, so that the SMC has an updated picture of the actual situation on board at all times, on the basis of which the operating strategies can then be decided.

Communications between the NAMIRG team and the helicopter will be performed with maritime VHF radios.

NAMIRG teams/external rescue units on board the vessel (principally) use their own communications devices (VHF, UHF).

If communications on board the distress vessel are prevented for structural or other reasons, the crew should reserve communications equipment for the MIRC teams insofar as this is possible.



COMMUNICATIONS PHILOSOPHY

Currently it is almost impossible to find ethnic uniformity among the crews, but if this leads everyone to express themselves in English to understand each other, the legacy of the original language in the pronunciation is very frequent, not only among sailors but very often in the figures of command.

In addition, the international standards require the use of "Standard Maritime English", a set of specific technical terminologies and pre-determined phrases in English issued by a permanent commission of experts that over time changes and suitably integrates them. Therefore a difficulty in understanding, even among those rescuers who have a general knowledge of English can be expected.

Should language difficulties arise, it is possible to refer to or contact the OSC (On Scene Coordinator) if present.

In order not to congest the emergency traffic on the maritime frequencies, the Fire and Rescue Service radio is used for operational communications, while keeping a listening watch on the VHF radios in the maritime band, possibly of the "triwatch" type, so as to monitor three channels at the same time (tugboat, helicopter and coast-guard for example), remembering that during the conversation on a channel, such devices temporarily exclude listening to the others.

It is important that the OC maintains his/her position at the command point, together with the ship's master, as a constant reference for the teams.

As to any serious emergency situation, it is essential at every stage of the operations to understand what strictly necessary INFORMATION needs to be requested or communicated concisely and clearly, to think about what must be said before starting the communication, choosing appropriate terms so as not to create misunderstandings.

Priority must be given to the messages to be transmitted and communications should not be interrupted unless there are any emergencies that require so; therefore, before transmitting, listen out to make sure that there is no transmission in progress.

Make sure that the receiver is ready to do so before starting to transmit and check that the message has been received. A brief reformulation of the message by the recipient is a very effective feedback.



THE RADIOTELEPHONE SYSTEM

CALL SIGN

The Call Sign, (C/S) or International Call Sign is assigned as a unique identifier to all radio stations, and is composed of alphanumeric characters.

VHF TRANSCEIVER

The VHF transceiver, commonly called VHF, is a metric wave system whereby emergency or routine VOICE CALLS can be made or received.

Some models include or allow a VHF DSC modem to be connected.

MF/HF TRANSCEIVER

The MF/HF transceiver, commonly called SSB, is a medium wave (MF) and short wave (HF) system that allows emergency or routine VOICE CALLS to be made, with the possibility to choose whether to communicate further by voice call or radiotelex.

PORTABLE VHF TRANSCEIVER

The portable VHF, is a metric wave system that allows VOICE CALLS to be made or received during rescue operations, between rescue vehicles and rescuers.

The effective radiated power must be at least 0.25W; if it is higher than 1W there must be the possibility of reducing it to less than 1W.

RESCUE, EMERGENCY AND SAFETY SIGNAL

A Distress Signal (DISTRESS by DSC or MAYDAY by voice call or radiotelex) means that a ship, plane, or person is in serious and imminent danger and requires IMMEDIATE ASSISTANCE.

An Urgency Signal (URGENCY by SDC or PAN PAN by voice call or radiotelex) means that a ship, plane, or person has an urgent problem to solve that could be dangerous if appropriate assistance from the ground or from another ship is not given.

A Safety Signal (SAFETY by DSC or SECURITE' by voice call or radiotelex) means that there is a danger to navigation that has not been broadcast adequately

PROCEDURES IN VHF, MF, HF

Using the ship's name as an identifier for distress communications seems to be the simplest and most immediate solution, but it has absolutely the same value as using the call sign, or a combination of both.

When the GMDSS (Global Maritime Distress and Safety System) is made mandatory the procedures listed below in MF, HF and VHF, will be performed with the DSC (Digital Selective Calling) and then followed by voice call or radiotelex.

CALL AND RESCUE MESSAGE

The CALL is made on an emergency frequency, followed by a short message (VHF CH 16 is used).

The distress signal consists of the word MAY DAY.

ROUTINE PROCEDURE

To make contact with a coastal station for purposes other than rescue, urgency and safety, the CALL is first made on a frequency, or channel, which the coastal station is tuned into, then it is passed over to a WORK frequency, or channel; in VHF, the call is made on CH16.

THE DSC SYSTEM

DSC DIGITAL SELECTIVE CALLING

The DSC is an integral part of the GMDSS. It is used by ships to transmit distress calls and from coastal stations to Acknowledge.

The DSC allows a message to be composed and transmitted automatically in VHF, MF and HF.

A DSC call automatically contains the following:

- MMSI (Maritime Mobile Service Identity)
- Position
- UTC (Coordinated Universal Time)
- Message composed of several fields of information containing the reason for the call (written, preset in the DSC modem).

4 Personal Sea Survival

Table of emergency signals

Organisation of the firefighting service on board provides a system of signalling the various types of emergency, including fires

ALARM SIGNAL

General emergency At least seven short blasts and one long blast on the ship's whistle

Fire on board Two long rings and rapid alarm bells rings for at least ten seconds code call ***INDIA VICTOR*** by loud speaker for Fire Teams

Leak Two long rings and code call ***DELTA X-RAY*** by loud speaker

Person overboard One long ring and code call ***OSCAR*** by loud speaker

Abandon ship Captain's order by loud speaker and continuous ring until complete abandon of ship



RESCUE VESSELS

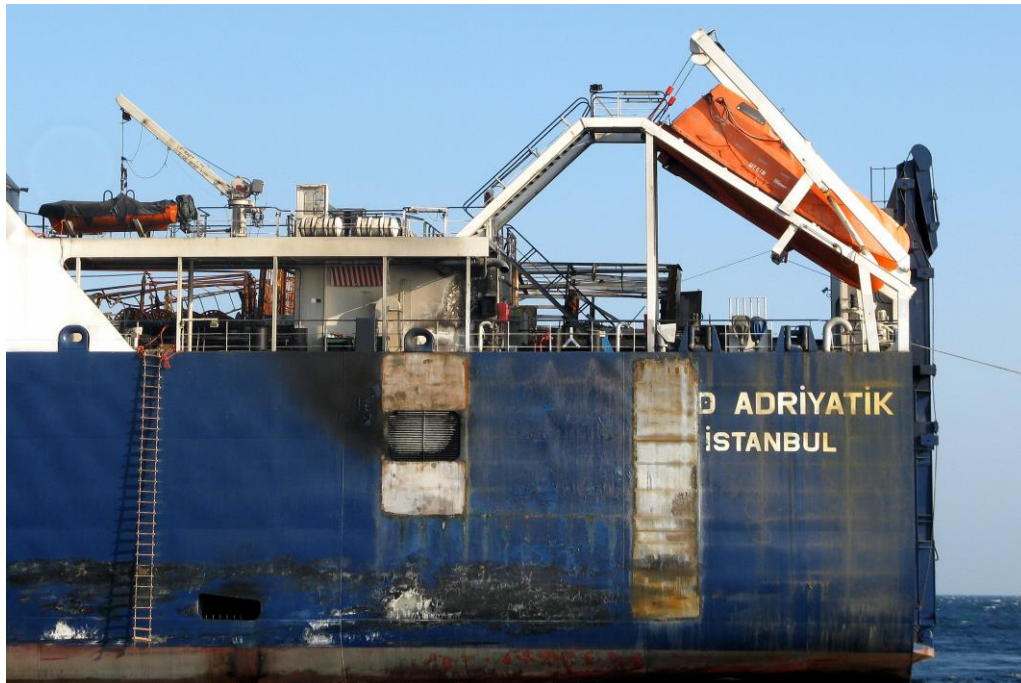

Rescue vessels are divided into:

- Lifeboats
- Life rafts/MES (Marine Evacuation Systems)
- Rescue Boats

The rescue means of a ship could be an escape if necessary.

On the rescue plan, displayed on all the main decks, the positions of all the rescue means and equipment are marked with appropriate symbols.

The instructions on the use of the means, generally in English, are located in their vicinity.

The use of life-saving equipment must be taken into consideration as a last resort in the event that the ship is abandoned.

The capacity of the various means is written on the hull, on the raft or on the raft container, and the name of the ship is written on the emergency boat.

The boats can be:

- open
- partially closed
- self-straightening
- completely closed
- completely closed with an air system
- with fire protection

- free fall

The boat is the main means of rescue on board ships as it offers:

- better protection
- more rescue equipment and provisions
- possibility of independent movement

On board ships there are also inflatable rafts, contained in a rigid protective shell. The capacity is marked both on the container and on the raft. Passenger ships (cruise ships, ferries, RO-RO Pax etc.) are equipped with various evacuation systems called MES (Marine Evacuation Systems), fitted with a slide or shod chute, etc., through which an atoll or a floating raft can be reached and from which other floating rafts can be embarked.

BOAT LAUNCHING METHODS

The methods of launching the boats are:

- with gravity crane;
- free fall

The mechanisms for releasing life-saving equipment are always painted in red

LAUNCH METHODS OF THE RAFTS

The methods of launching the rafts are:

- manual
- by crane
- automatic release
- MES Marine Evacuation Systems

Manual launch:

- release the saddle straps and make sure that the top that comes out of the container is connected to the ship
- throw the whole container in the water
- a pull immediately from the top inflates the raft, if it does not happen tug it manually from the top

Launch by crane:

- release the raft from the saddle and hook it to the crane
- tie it to the boarding point
- pull the top that comes out of the container to inflate the raft
- embark and lower the raft into the water

Automatic release when the ship sinks within 4.5 m:

- as the ship is sinking, the hydrostatic hook releases the fastening belts of the raft to the saddle;
- the container floats;
- the top is tensioned by the floatation of the container causing the raft to inflate; the weak ring at the top that fixes the raft to the ship breaks, freeing the floating raft
- survivors can climb the raft from the water.
- in the event that the raft overturns, it should be repositioned correctly;



- if the connecting rope to the ship has not been severed, use the knife on board;

MES:

- follow the instructions for automatic system activation
- use the descent system on the atoll/raft as outlined in the instructions
- climb on board the raft and check whether it needs to be detached from the atoll

EMERGENCY BREATHING SYSTEMS

Survival Egress Air (SEA) LV2

General Precautions & Warnings

The SEA is intended for use only as an emergency device to assist a crewmember or passenger in making an emergency egress from a submerged aircraft. Due to its limited air volume, it is not intended for use while scuba diving, or egressing from depths greater than 13.5 m.

Visual inspection and factory prescribed service for the SEA must be performed at least once every two years by a factory trained and qualified service technician. Repair, service, and visual inspection must not be attempted by untrained or unqualified personnel.

DO NOT apply any type of petroleum-based lubricant, such as household oil or motor oil to any part of the SEA. The SEA does not require any lubrication under normal circumstances, except that which is performed during annual inspection and service by a factory trained service technician.

DO NOT apply any type of aerosol spray to the SEA. Doing so may cause permanent damage to certain plastic components, including the second stage housing.

During training exercises, it is important to ensure that the SEA is always pressurized whenever it is submerged in order to prevent the entrance of water into the system.

Whenever the system has been completely emptied of air underwater, it is important to return the SEA as soon as possible to a qualified technician for visual inspection and any necessary service before attempting to refill it.

pre-Flight Inspection

The pre-flight inspection shall be performed on the SEA prior to each flight by the air crew member to whom the unit is assigned. Pre-flight procedures are as follows:

Strict compliance of pre-flight and post-flight inspections shall be adhered to by all air crew members utilizing the SEA. Any signs of discrepancies shall be reported immediately to maintenance personnel.

1. With the system off, visually inspect the SEA for signs of damage. Inspect front cover, exhaust cover and fittings for tightness. Inspect for tamper dot (if command uses tamper dot) on front cover. Inspect hose for cuts and blistering. Inspect for contamination, dirt and signs of corrosion.



Do not press the purge button when the SEA is on. Purging of the SEA will deplete the pressure below the "GREEN ZONE" and it will have to be topped off by maintenance personnel

2. Turn the SEA "ON" by rotating the on/off knob to the left (counter clockwise), the red indicator ring shall not be seen through the elongated holes on the knob. Ensure that the gauge reads in the "GREEN ZONE". If the gauge does not read in the "GREEN ZONE" report discrepancy to maintenance personnel.

Post-Flight Inspection

Upon completion of flight, turn handwheel off (clockwise), so that red indicator ring is visible through the elongated holes on the handwheel. Depress the purge button to relieve pressure in hose and second stage. Check SEA for signs of damage and contamination. Report discrepancies to maintenance personnel.

If the SEA cylinder does not contain air, it is important to ensure that the valve is completely turned to the "OFF" position, and the second stage purge button is not depressed while the system is submerged or wet. Moisture may otherwise be allowed to enter the valves and the cylinder, which will require that the system be returned to a qualified technician for inspection and service.

DO NOT store the SEA partially filled. Doing so may prevent the safety relief assembly from functioning properly in the event of fire or exposure to extreme heat. This may cause the cylinder to rupture or explode, possibly resulting in severe injury or death.

Technical Specifications

Cylinder Volume	0.425 litres
Cylinder Material	Aluminium
Cylinder Length with Regulator	26.67 cm
Rated Cylinder Pressure	206 BAR
Low Pressure Hose Length	50.8 cm
First stage Hose Connection	360 degree swivel
Regulator First Stage	Unbalanced Piston
Regulator Second Stage	LV2
Pressure Gauge	Pin-type, integrated with First Stage or dial gauge
Over Pressure Relief	Safety Burst Disc Assembly First Stage Mounted
System Weight Approximately	1.36 kg
Buoyancy Full Approximately	-0.9 kg
Duration of Air Supply	**Approximately 21 breaths at 6.4 m.

*Based on pn 108330, SEA with 0.425 litre bottle

**Based on an average breath volume of 1.5 litres at a breathing rate of 10.5 bpm, with a starting supply pressure of 206 BAR



5 Helicopter Operations

HELICOPTER (MI-8MTV1) SAFETY PROCEDURES

The MI-8MTV1 helicopter is used to carry passengers and cargo, as well as to carry out special airborne operations. The helicopter has five blades on the main rotor and three blades on the tail rotor as shown in the diagram below. It has two 1470 kW (2000 Hp) TV3-117VM turbine engines each allowing the helicopter to stay in flight or land even if there is an engine failure, by bringing the other engine to a power regime of 1617 kW (2200 Hp).

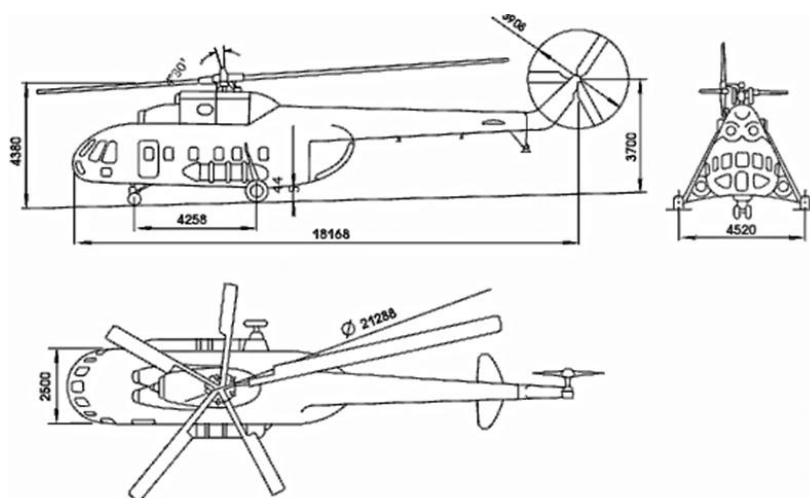

The helicopter can be used for the following purposes:

- transport (without additional fuel tank) a maximum load of 4000 kg or 24 passengers.
- medical transport, with the possibility of transporting 12 patients on stretchers including assisting staff.
- transport of large loads, outside the transport cabin, with a maximum load of 3000 kg
- transport with two additional tanks to allow the maximum self-sufficiency.

The helicopter is equipped with an LPG-150 electric winch to hoist loads up to 150 kg, as well as boarding loads up to 3000 kg in the cabin using pulleys.

General helicopter data:

Helicopter length (m)

- excluding main and tail rotors 18.219
- including main and tail rotors in motion 25.262

Helicopter height (m)



- excluding tail rotor	4.756
- including tail rotor in motion	5.521
Width of the fuselage (m)	2.5
Distance of the fuselage from the ground (m)	0.445
Diameter of main rotor (m)	21.294
Diameter of tail rotor (m)	3.908
Length of the stowage area (m):	
- excluding loading hatch	5.34
- including loading hatch	7.82
Stowage area width (m):	
- flatbed	2.06
- maximum	2.34
Stowage cabin height (m)	1.8
Dimensions of sliding door (m)	0.82x1.4
Take-off mass (kg):	
- maximum	13000
- normal	11100
Transportable load (kg)	
- full load	4000
- suspended load	3000
Mass with no load (kg)	7085
Maximum speed (km/h)	250
Cruising speed (km/h)	220-250
Maximum operating altitude (m)	6000
Maximum range of action (km)	465
Fuel consumption (l/hr)	800-900

HELICOPTER TRANSFER TO A VESSEL/STRUCTURE AT SEA

TRANSPORTATION AND LANDING OF FIREFIGHTERS WITH HELICOPTER

The use of a helicopter to transfer and disembark firefighters is inspired by military use. The military can also be transferred by helicopter over long distances so that they can quickly enter enemy positions, both in open spaces and urban areas.

To transfer firefighters by helicopter, certain boarding points need to be predetermined where this manoeuvre can be performed safely, while landing can take place in various ways, depending on the type of intervention required. For interventions on ships, the firefighters are lowered by winches from the helicopter at low altitude.

The MI-8MTV1 helicopter can carry up to twenty-four fully equipped firefighters, in forest firefighting gear.

This transport capacity clearly exceeds the needs of the NAMIRG team, which is normally composed of six operators.

SAFE METHODS OF APPROACHING AND LEAVING THE HELICOPTER

For safe landing and for boarding/disembarking firefighters and equipment, it is essential to guarantee a 50 m² flat area. If the helicopter has to land on sloping ground, the inclination/gradient must be assessed as well as the consistency of the ground so as to avoid sinking of the undercarriage wheels.

The Mi-8MTV1 helicopter is suitable for off-road landing (see figure below), thanks to the large space between the undercarriage and the 400 mm ground clearance, which gives excellent stability on slopes and the possibility of landing on rocky points or points that have little vegetation; a very frequent situation in coastal areas.

Boarding of the NAMIRG team will then take place at fixed boarding points and with the appropriate conditions to ensure this operation is carried out safely, while the landing will take place by winching all personnel and related equipment, as the helicopter is not authorised to land on a ship's deck.

This helicopter is not equipped with avionics for automatic positioning in hovering.



Landing and off-road landing of firefighters

The operating potential offered by the use of a helicopter for rapid transfer of firefighters is evident, especially in the event of fires on islands or other points that are hard to reach,

as well as on ships out in the open sea. In inaccessible and high-altitude areas, helicopters are an irreplaceable means for transporting firefighters.

If there is no favourable landing point for the helicopter, other landing methods can be used, such as descent by rope using mountaineering techniques, jumping from the helicopter suspended in the air a few centimetres from the ground or winching with the LPG 150 winch; the latter, as mentioned, being the only method that can be used by the NAMIRG team.

When using the helicopter, the fire and rescue service must pay the utmost attention to the safety measures provided and must carry out the instructions given by the crew on board.

In choosing a point where the firefighters will wait to board the helicopter, the wind direction must be taken into account, as the helicopter will land upwind. The helicopter must be approached from the front, so that the crew can see the group of firefighters, possibly at 45° to the left of the pilot (see figure below). Firefighters and equipment are boarded using the front door of the loading cabin next to which the flight technician is located. Firefighters will have to move towards the helicopter in a bent position and at a distance of a couple of meters from each other. Approach from the rear of the helicopter is forbidden, since the working tail rotor cannot be seen, due to the high number of revolutions, hence it is extremely dangerous.

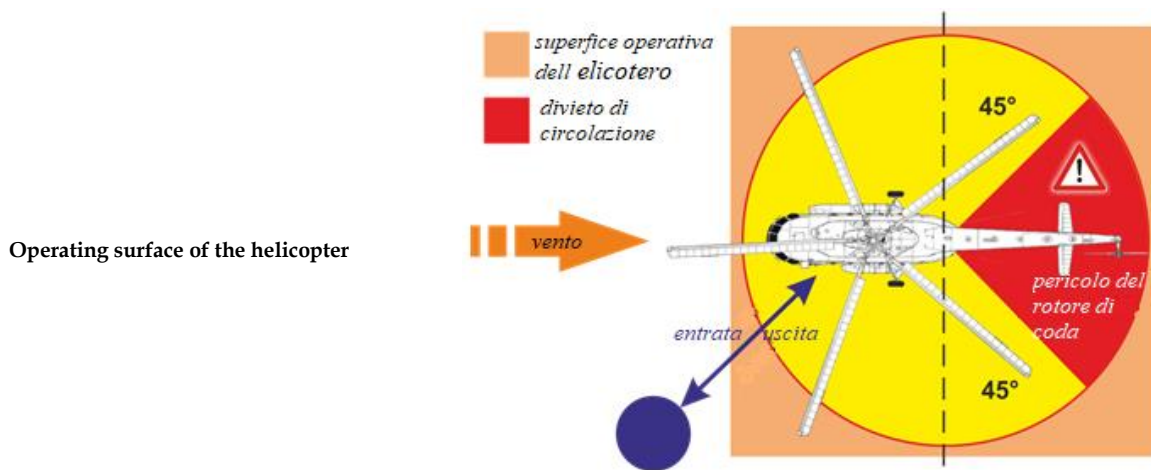

superficie operativa dell'elicottero	helicopter operating range
divieto di circolazione	prohibited access to the area
pericolo del rotore di coda	tail rotor hazards
vento	wind
entrata	entry

uscita	exit
--------	------

The team of 24 operators must be divided into smaller groups, preferably aligned in two rows (see figure below). Each team must have its own leader, i.e. team leader. The firefighters, each with their own equipment on their backs or next to them, will wait in a crouched position for the helicopter to arrive.

Team ready for boarding



When the helicopter lands, the team leader will wait for a signal from the flight technician who, after landing, exits the helicopter and stands next to the side hatch. When the flight technician gives the boarding signal, the team leader approaches the helicopter to give him/her the data concerning the number of firefighters, the number and type of equipment and approximate weight that require transporting. At this point, the team leader stands next to the helicopter side door with his/her back to the helicopter to check the approach of the operators, keeping the ladder locked with his/her foot (see figure below) and signalling to the rest of the group to start the boarding manoeuvre.



The fire & rescue team leader

The group approaches the helicopter quickly, in a bent position and a couple of meters away from each other (see figure below). After boarding, the firefighters sit on the left and right seats alternately, starting from the back and fastening their seat belts, following the instructions given by the crew.

The team leader will be the last to board.

The firefighting equipment will be positioned in the central part of the loading cabin, according to the instructions given by the helicopter crew, so as not to unbalance the centre of gravity and alter its manoeuvrability.

The information on the weight on board is essential to calculate the operational sufficiency of the helicopter, so it must be as accurate as possible, especially when having to use smaller helicopters



Boarding the helicopter

Disembarkation will take place in reverse order: the team leader, on the signal of the flight technician, will be the first to exit the helicopter and, if the helicopter is on the ground, will stand next to the hatch and hold the ladder down. At this point he/she will give the other firefighters of the team a signal to start disembarking. Disembarkation will be performed alternately from left to right, moving from the back towards the front door, sliding on the seats. To get up or move around in the helicopter is not allowed, except for boarding and disembarking. Once the firefighters have exited the helicopter, they will move away quickly in a crouched or bent posture, at 45° from the longitudinal axis of the helicopter.

After all the firefighters have disembarked, the team leader checks whether any equipment has been left in the helicopter and reports the data to the flight technician, then joins the team and together they await take-off of the helicopter.

If the helicopter is unable to land due to the configuration of the terrain or other obstacles, the ladder cannot be used and, in this case, the firefighters will have to jump. The procedure will always be the same: the team leader will jump first and will stand next to the door, then the other firefighters will jump one by one, landing on both legs and will move away from the helicopter.

The equipment must be handed over to the colleague who has just exited the helicopter, provided the height allows it, otherwise it must be unloaded safely.

This type of landing can be carried out up to a maximum height of 1 m

LPG 150 WINCH

The LPG 150 winch is used to load and unload equipment and is located externally to the fuselage, in the front top corner of the loading cabin door. The winch consists of two reversible electric motors, reduction gear, cable winch and microswitch for stopping the cable winding. Together with the winch is the drive box and shaft, located inside the helicopter. Moreover, using the winch and the pulley system, it is possible to load equipment on wheels, whose mass does not exceed 750 kg, through the rear loading door. The load is secured by means of a locking hook. The manufacturer has foreseen the possibility of hoisting/lowering the operators from the helicopter in flight by means of the LPG 150 electric winch. During its use, having noticed some defects, the manufacturer has given instructions that the LPG 150 winch be used for hoisting/lowering people only in the event of rescue operations. The steel cable of the winch is 40 m long, which limits the maximum altitude of the helicopter in case of personnel hoisting/lowering. The number of hoisting operations without a STOP depends on the height of the helicopter. In practice, after every 2-3 hoisting operations the helicopter will move, fly around the landing/boarding point and then reposition itself and resume the hoisting/lowering operations.

The personnel moving procedures inside the cabin when disembarking by means of the winch will be similar to those described above; nevertheless, instructions given by the crew on board must be followed. Sudden movements of the load must be avoided, personnel will slide along the seats to the front door, from the left and from the right, alternately, moving the bags containing equipment in a longitudinal direction of the helicopter, unloading them as soon as possible, so that the personnel who has already disembarked can place them in a safe position and start kitting out.

Technical data of the LPG 150 winch:

- Power supply	27 V
- Maximum cable load	150 kg
- Speed of ascent of the cable with two motors	0.5 m/s
- Speed of descent of the cable with two motors	1 m/s
- Cable length	40 m
- Cable diameter	3 mm
- Winch weight	21 kg

The winch can be turned to three positions. When the load is hooked onto the cable the flight technician lifts it slightly with the help of the winch, then pushes it out of the cabin and lowers it (see figure below).

During helicopter descent, the load must not swing and the cable must not get stuck. When the load touches the ground, the winch motors automatically switch off. When the ground firefighters release the load, they give the flight technician a signal, who then manoeuvres the winch and rewinds the cable. If the cable gets stuck, the flight technician immediately informs the commander of the helicopter and, only upon his precise order

can the cable be cut. When manoeuvring with a winch, the technician must fasten his/her seat belt/harness.



Hoisting a load using the LPG 150 winch

RESCUE WITH THE LPG WINCH AND STRETCHER

An injured person on a stretcher can be rescued by hoisting.

The maximum lifting capacity of the winch is 150 kg, which prevents the injured person from being hoisted together with the rescuer.

After having lowered to the ground, the rescuers stabilise the injured person by putting him/her on a stretcher, which is prepared, secured to the winch cable and then the flight technician is given a signal by the rescuer to start the hoisting operation. The cable must be an anti-rotation cable to prevent the stretcher from rotating whilst being hoisted and the straps must be adjusted so as to keep the casualty's head slightly higher than their feet to simplify the introduction of the stretcher in the helicopter. When the winch hook reaches the highest point of elevation, the head end of the stretcher is at the level of the helicopter floor, the rescuers in the helicopter grab the stretcher, while the flight technician manoeuvres the LPG winch to ease entry of the stretcher.

6 Support & Safety Vessels

NAVAL VESSELS OF THE PROVINCIAL COMMAND OF THE FIRE AND RESCUE SERVICE (VVF) OF TRIESTE

(Fire and Rescue Service (VVF) Detachment Location Porto Franco Vecchio, operational 24H)

NAME	TYPE	SIZE	ENGINES	FIREFIGHTING SYSTEM
VF 1175 (YRG)	<i>FIREBOAT large with FLIR system</i>	LOA 28.12 m Beam 5 m Draft 1.85 m Displacement.14 4.4 t	Two <i>MAN D2842 LE408</i> 735 KW <i>endothermic diesel engines</i> - Top speed 14.8 knots	Two Chinetti motorpumps Flowrate 10000 l/min prevalence 12 bar. Three foam cannons with 60000 l/min flowrate and 60 m range. 13,000 l foam extinguisher tank
VFR 07	<i>FIREBOAT RAFF</i>	LOA 13.3 m	Two <i>MAN D2866</i>	One AIFO 8061M14 90 KW engine



(IFNK2)	<i>(Rescue and Fire Fighting)</i> with FLIR system	Beam 3.9 m Draft 0.9 m Displacement.18.4 t	LE405 455 KW diesel engines Two hydrojets Top speed 30 knots	with one firefighting pump, flowrate 4000 l/min, prevalence 10 bar. One water cannon with 2000 l/m flowrate and 60 m range 500 l foam extinguisher tank
----------------	--	--	--	--



**NAVAL VESSELS OF THE LICENSED COMPANY OF THE TUGBOAT SERVICE
TRIPMARE S.p.A. IN THE PORT OF TRIESTE**

The service is covered by seven tugboats: three with Voith Schneider propulsion system and four with propeller. The latter are preferable for navigation as they are faster with the same power even though they have "minor" manoeuvrability.

As already stated, the presence of 4 tugboats in continuous service must be guaranteed and one on stand-by to be ready within one hour.

All tugboats have the FFQ1 standard, which includes 2 cannons, each having a capacity of 1200 m³/h at a distance of 110 m, and additional 300 m³/h for self-protection for a total of 2700 m³/h. They are also equipped with 4 water delivery systems on each side with Storz connections, so as to bring a line of hoses on board the unsafe vessel, with the possibility of powering the fixed on-board system through the International Shore Connection. The



equipment also includes a pump and its on-board 50m³/h firefighting system. Two tugboats have 6% PROFLON foam on board (**Altair** 20m³ and **Centurion** 12 m³). In addition, propeller tugboats are suitable for loading a 20' container or a smaller one. In the event of a rescue operation at sea these units need a specific preparation.

NAME	STANDARD	CAPACITY A.I. in m ³	SPEED (IN KNOTS)	PROPULSION	FOAM ON BOARD
ALTAIR	FFQ 1	2700	8/12 kn	Voith Schneider	20m ³
CENTURION	FFQ 1	2700	8/12 kn	propeller	12 m ³
GLADIATOR	FFQ 1	2700	8/12 kn	propeller	
DENEB	FFQ 1	2700	8/12 kn	Voith Schneider	
DAVIDE	FFQ 1	2700	8/12 kn	propeller	
URAN	FFQ 1	2700	8/12 kn	Voith Schneider	
VEGA	FFQ 1	2700	8/12 kn	propeller	

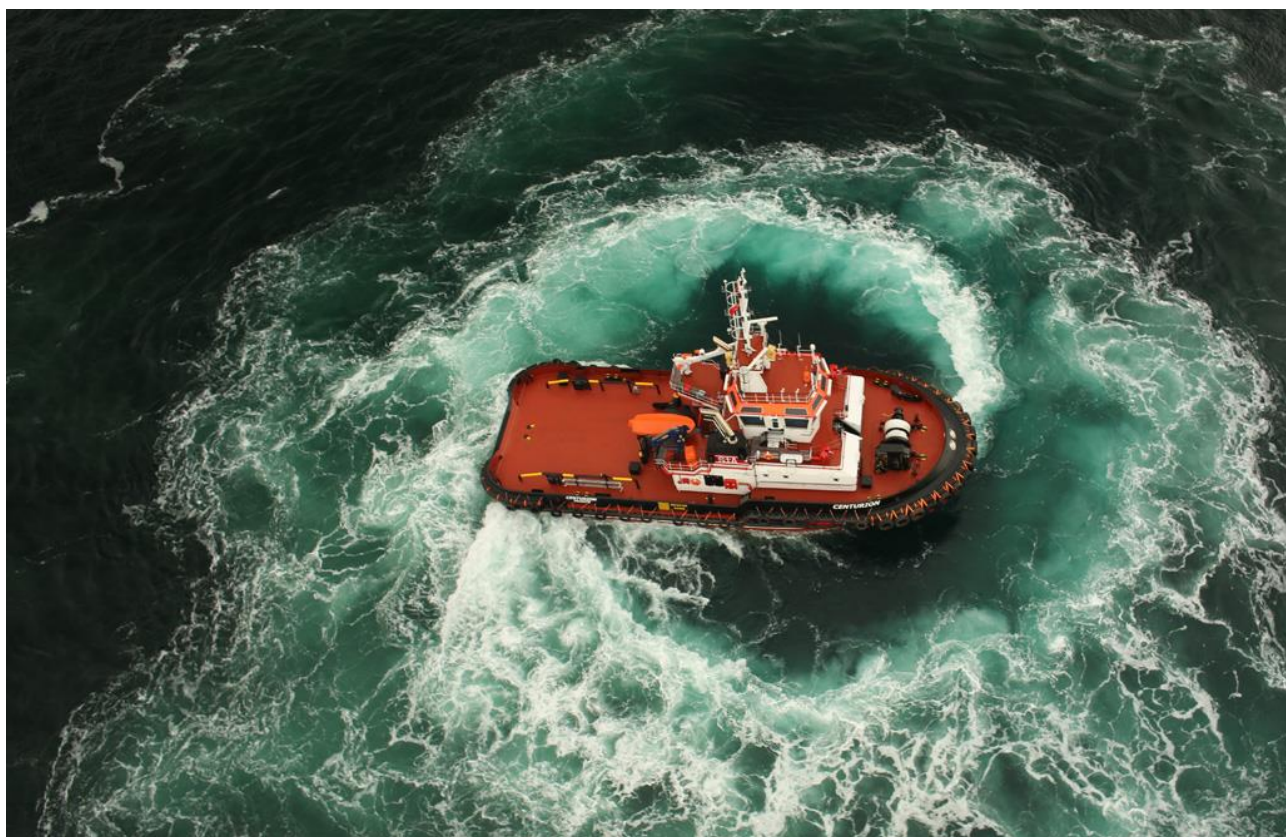

Centurion Tugboat

NAVAL VESSELS OF THE PORT AUTHORITY (CP)/COAST GUARD (GC) IN THE PORT OF TRIESTE

NAME	TYPE	SELF-SUFFICIENCY	SPEED (IN KNOTS)	PROPULSION	RANGE OF ACTION
CP 822	MOTOR PATROL BOAT S.A.R.	150 miles	28/32 kn	hydrojet	75 miles



CP 277	MOTOR PATROL BOAT	680 miles	26/34 kn	hydrojet	320 miles
CP 2084	MOTOR PATROL BOAT	320 miles	21/24 kn	propeller	150 miles
G.C. B32	INFLATABLE BOAT	220	29 kn	Outboard propeller	coastal



Motor Patrol Boat CP 822



Motor Patrol Boat CP 277





Motor Patrol Boat CP 2084

APPROACH TO THE SHIP

The approach to the moored ship provides a whole series of options depending on the type of ship and the port facilities available.

In the event of RO-RO ferries, it may even be possible to get firefighting vehicles on board, if needed.

In any case, it will be possible to get on board with the ship's gangway, the firefighters' ladder, a quay winch, etc.

If the ship is anchored in the harbour or at sea it is possible to use the gangway or Jacob's ladder (*rope ladder, normally used by the pilot of the port*), which is lowered by the staff on board the ship along the sides (*sides of the hull*).

It is also possible to use them at the same time, using Jacob's ladder to access the gangway.

In the ports where a nautical detachment of the Fire & Rescue Services is foreseen, the nautical means will be used to transfer personnel alongside the ship together with the necessary equipment that has already been prepared. Once transhipment has been completed, these means will serve to provide assistance to the teams, integrating the extinguishing activities with the firefighting services on board.

In the absence of its own means, transfer takes place with suitable boats supplied by the Maritime Authority.





REQUIRED BOARDING ARRANGEMENTS FOR PILOT

In accordance with I.M.O. requirements and I.M.P.A. recommendations
INTERNATIONAL MARITIME PILOTS' ASSOCIATION
 H.Q.S "Wellington", Temple Stairs, Victoria Embankment, London WC2R 2PN. Tel: +44 0171-240-3973 Fax: +44 0171-240-3518

RIGGING FOR FREEBOARDS OF 9 METRES OR LESS

HANDHOLD STANCHIONS
Min. diam. 32mm
120mm above stanchion rail, 70mm max. 40mm apart

MAN-ROPES
without knots
min. diam. 28mm
IF REQUIRED BY PILOT

SPREADER
Min. 180cm long

SIDES ROPES
Min. diam. 18mm

STEPS
Must rest against ship's side

5th step must be a spreader

Height required by pilot

SHIPS WITH HIGH FREEBOARD (MORE THAN 9M)

When no side door available

PILOT LADDER
Must extend at least 2 metres above lower platform

ACCOMMODATION LADDER
Should rest firmly against ship's side
Should lead aft
Maximum 55° slope
Lower platform horizontal
Rigid handrails preferred

A PILOT LADDER COMBINED WITH AN ACCOMMODATION LADDER is usually the safer method of embarking or disembarking a pilot on ships with a freeboard of more than 9 metres

Recommended 9 metre mark
Stern --- Bow

MECHANICAL PILOT HOIST

Two man-ropes ready for immediate use
Min. diam. 28mm

Guard ring

Rigid part

Flexible part

A pilot hoist made and rigged in accordance with SOLAS Chapter XI together with a pilot ladder rigged alongside for immediate transfer, may be used subject to agreement between the Master and the Pilot. It should be noted that the distance between the nearest side ropes of the pilot hoist and pilot ladder will be at least 1.4 metres.

NO!
No shackles
No knots
No splices

NO!
The steps must be equally spaced

NO!
The steps must be horizontal!

NO!
Spreaders must not be lashed between steps

NO!
The side ropes must be equally spaced

NO!
The loops are a tripping hazard for the pilot and can become foot of the pilot launch

NO!
Very dangerous ladder too long

Two handhold stanchions rigidly secured to ship's structure

Ladders with self-closing gates

Subwark ladder secured to ship

AT NIGHT
Pilot ladder and ship's deck lit by forward shining over-side light

Approved by I.M.O. March 1995

Should the ship in danger be out at sea it may be necessary to climb on board while the ship is in motion, with the difficulties and risks that this manoeuvre entails.

Jacob's ladder, unlike the climbing gangway, involves the risk of falling, so a safe climbing technique (SAF) is used, making the first firefighter with the SAF equipment necessary climb on board to then secure all the other operators.

TRANSPORTATION OF THE INTERVENTION MATERIAL

The type of equipment to be brought on board must be organised in advance according to the access methods and means of transport.

Once on board the ship, the necessary operating equipment will have to be lifted on board. This operation will be different depending on whether the ship is moored or out at sea. In the first case, transfer of the material does not present problems other than those of a common rescue operation.

On the other hand, in the event of a ship at sea, transshipment of materials must be done manually.

Once on board, two main scenarios can be configured:

- self-sufficient ship with systems working;
- non self-sufficient ship with no systems or systems that are not functioning;

In the first case, the intervention team will be able to count on the fire-prevention devices of the ship shown in the fire plan/safety plan.

In the second case, the international connection can be used to connect the pump of the Fire & Rescue naval unit to the ship's line to continue powering the ship's firefighting system.

In adverse weather conditions, the operations described above cannot be carried out successfully by naval means and airborne craft must be used.

7 Practical Techniques

FIRE BEHAVIOUR

FIRE DEVELOPMENT

DIFFERENT PRESSURES IN A COMPARTMENT

As a fire develops inside a compartment, it will generate hot fire gases which will expand, increase in buoyancy and rise to the ceiling, causing an over pressure. As the fire uses up the air in the lower level of the compartment, it will cause an under pressure, so two separate layers start to appear

The upper layer (over pressure) will contain the products of combustion and pyrolysis (fire gases) and the lower layer (under pressure) will contain the remaining air in the room. Dividing these two layers is the neutral plane.

The position of the neutral plane in a compartment will depend on the amount of ventilation, the size of the compartment and height of the ceiling, the temperature and development of the fire and how many fire gases are produced.



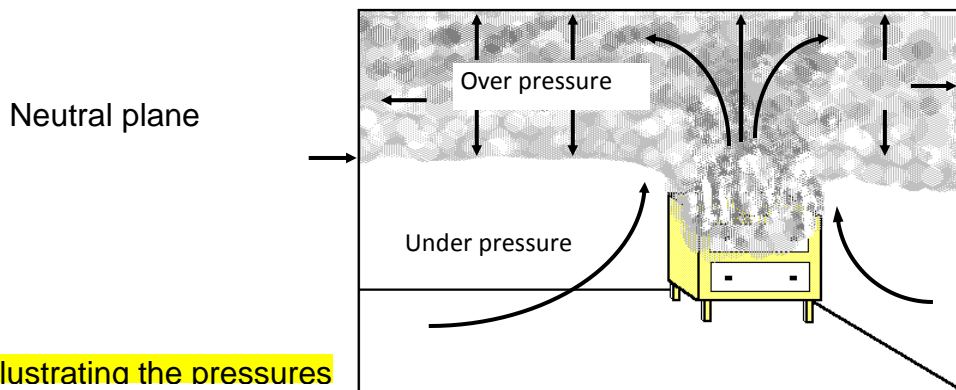

Picture illustrating the pressures

In the upper layer the expanding hot fire gases generated by the fire are contained by the compartment boundaries (ceiling and walls), causing an over pressure. The over pressure pushes on the ceiling, the walls and the neutral plane. In the lower layer the air is being used up by the fire, causing an under pressure. If there is insufficient ventilation to the compartment, as the fire develops the over pressure increases (as more fire gases produced) and the under pressure decreases (more air used up). Both of these small changes in pressure will move the neutral plane down.

FIRE GASES

Fire gases (smoke) are the collection of gases produced by the fire and can be divided into four main groups:

- **Non-flammable gases.** Due to pyrolysis and incomplete combustion, mainly carbon dioxide and water vapour.
- **Flammable gases.** Due to pyrolysis and incomplete combustion, i.e. formaldehyde, hydrogen cyanide, hydrogen chloride, with carbon monoxide being the most common.
- **Air.** Entrained up into the fire gases by the rising temperatures from the fire.
- **Soot.** Carbon particles floating in the gases.

Picture illustrating the basic constituents of smoke in a room fire

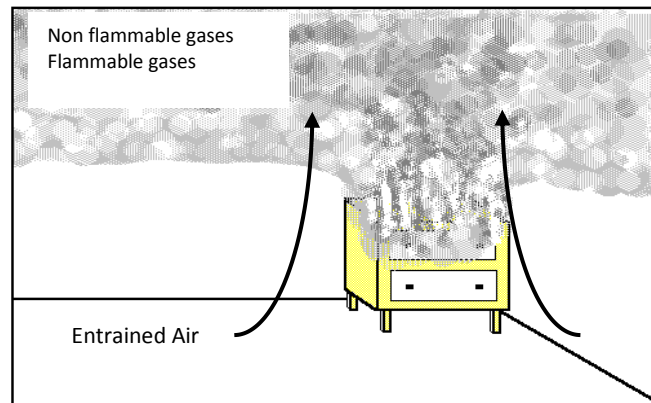

In a compartment, the consistency of fire gases will vary as the fire develops i.e:

Combustion. Because at the early stages of the fire there is sufficient air available, combustion will be quite efficient, producing mainly carbon dioxide and water vapour. However, as the air in the compartment is used up, combustion becomes inefficient, with lesser quantities of carbon dioxide (CO_2) being produced in favour of carbon monoxide (CO), as there is less oxygen (O_2) available for the chemical reaction to occur efficiently.

Pyrolysis. Initially when the temperatures are low, a large proportion of the gases produced are carbon dioxide and water vapour, with small amounts of carbon monoxide (CO) being given off. As the temperature rises (i.e. above 300°C for wood), the consistency of the gases alters, with carbon monoxide (CO) being the predominant vapour, and small quantities of carbon dioxide and water vapour being generated.

The amount of flammable gases given off by the fire, as can be seen, is due to a number of factors:

- **Ventilation.** The less the ventilation to the compartment, the more incomplete the combustion, producing higher quantities/ratios of flammable gases. If the ventilation is restricted to the compartment, as the fire develops it will use up the air. As the air is used up in the compartment and combustion becomes inefficient, more carbon particles (C) will be produced by the chemical reaction.
- **Fuel.** Different fuels produce different flammable gases with varying levels of flammability, some substances produce higher quantities of flammable gases (i.e. plastics, foam, rubber etc.)
- **Temperature** can affect the ratio of flammable/non-flammable gases in pyrolysis. It can also affect the chemical reaction during combustion and therefore the products (flammable gases) will vary in type and consistency.

COLOUR OF FIRE GASES

The colour of fire gases produced by the fire and exiting from the openings of the compartment will vary depending on a number of factors:

- **Density.** The more diluted the fire gases become, the lighter they appear; the more compressed (dense) they become, the darker their appearance
- **Ventilation.** The more the ventilation available to the fire, the more efficiently the fire will burn often reducing the amount of fire gases and appearing light in colour. If the air supply is restricted to the fire, combustion will become inefficient and affect the chemical reaction. This change in the reaction will produce different substances (i.e. carbon), causing the colour to darken
- **Temperature.** The temperature can affect the chemical reaction, and the substances produced can vary in type and consistency as the temperature changes (see reference in previous section on pyrolysis)
- **Fuel.** When fuel burns in a fire, it will produce a different substance(s) due to the chemical reaction (combustion). Subsequently if different fuels are burning they can each produce different substances as the result of combustion. These different substances being produced can vary in colour. i.e:
 - Thick black fire gases Hydrocarbons, (diesel, petrol)
 - Yellow fire gases Sulphurous material (some plastics)
 - Grey fire gases Cellulosic material, (wood)
 - White fire gases Smouldering foam rubber

It is therefore very difficult to recognise how dangerous the conditions are from the colour of the fire gases alone; i.e. white fire gases could be a small amount a timber burning in a well ventilated compartment (low risk), or it could be foam rubber burning in an unventilated compartment (high risk)

The assessment of the conditions must always be supported by other information; i.e. the amount of ventilation to the compartment, the density of the fire gases and the energy forcing them out the compartment

LIMITS OF FLAMMABILITY

Definition of terms:

LEL Lower explosive limit or the **LLF** (lower limit of flammability).

The lowest concentration of fuel to air mixture that will just support a flame.



IM Ideal mixture or the Stoichiometric mixture.

The most efficient concentration of fuel to air mixture that produces the highest temperatures, the largest and quickest reaction.

UEL Upper explosive limit or the **ULF** (upper limit of flammability).

The highest concentration of fuel to air mixture that will just support a flame.

FLAMMABLE RANGE SUMMARY

If a room contains a pre-mixture of flammable gas (i.e. carbon monoxide, produced from a smouldering fire) and air, plus an ignition source, it will only ignite providing the gas is within its flammable range (i.e. between the LEL and the UEL). If the mixture is below its LEL then it is too lean to ignite and if the mixture is above the UEL then it is too rich to ignite. If the mixture is between the LEL and the IM then a lean burn will develop. If the mixture is between the IM and the UEL then a rich burn will develop. The nearer the mixture is to the IM then the greater the intensity/force of the ignition, see example below.

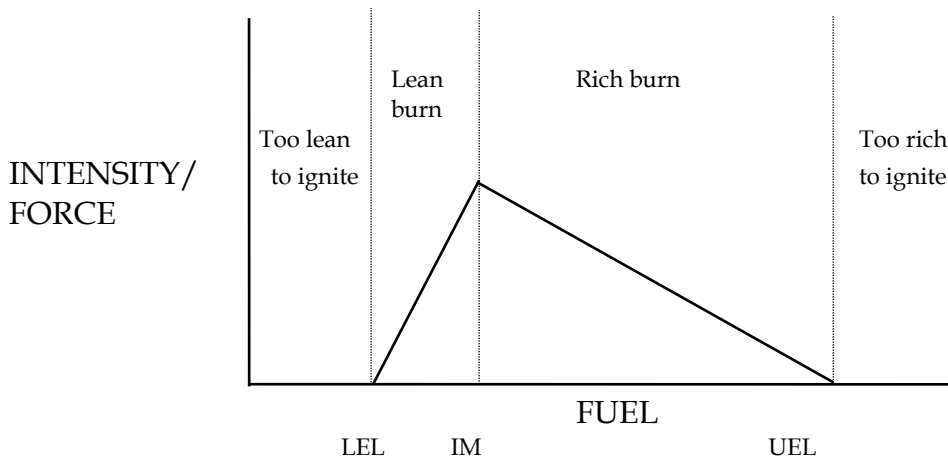

Graph summarising the flammable range

FLASHOVER & BACKDRAUGHT

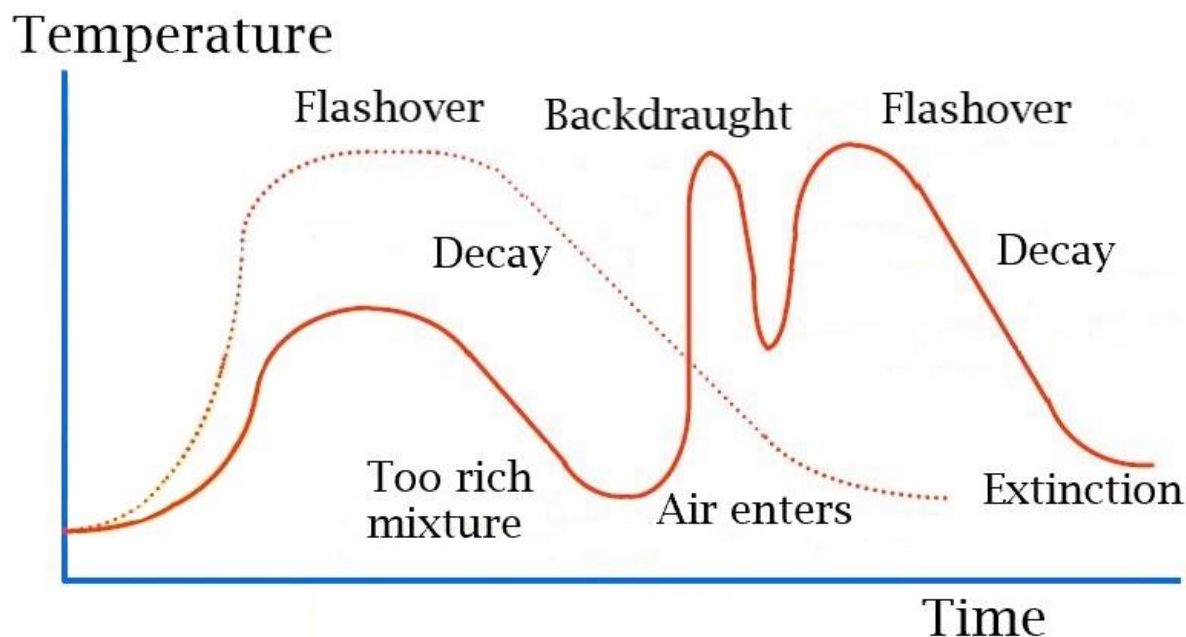

BACKDRAUGHT

Limited ventilation can lead to a fire in a compartment producing fire gases containing significant proportions of partial combustion products and unburned pyrolysis products. If these accumulate then the admission of air when an opening is made to the compartment can lead to a sudden deflagration. This deflagration moving through the compartment and out of the opening is backdraught

Signs and symptoms of a backdraught

A **backdraught** is the development of fire in a compartment **with no or limited ventilation**, which is then ventilated after a period of time. If a fire has been burning for some length of time with no or limited ventilation, all of the oxygen may have been used up and a too rich mixture is more likely to be present.

Symptom - compartment with no or limited ventilation

External Signs:

- **Compartment with no or limited ventilation**
- **Fire gases being pushed out under pressure from gaps.** If the neutral plane has reached floor and pyrolysis continues due to the heat retained in the compartment, the over pressure inside the compartment increases and forces the fire gases out through any gaps in the structure (i.e. gaps around doorways, windows, air vents, tiles on roof etc.)
- **Windows blackened with no visible signs of flame.** With oxygen being used up inside the compartment, incomplete combustion occurs. Carbon particles are a by-

product of incomplete combustion, as oxygen levels reduce, production of carbon particles increases, which will be deposited on the surfaces of the compartment. As a too rich mixture starts to develop flames start to die back due to lack of oxygen. Flames can also be obscured due to the thick fire gases above the neutral plane.

Fire gases pulsing out from gaps. If a too rich mixture has developed inside a compartment, as the fire dies down eventually the temperature will start to drop. As the temperature of the hot fire gases inside the compartment drop, the gases contract, the over pressure will decrease and air will be drawn in through any small gaps. This can allow some of the fire gases to dilute into their flammable range and produce a localised explosive mixture, which may ignite (mini backdraught). If these fire gases ignite, the over pressure increases, forcing the fire gases out through any gaps in the structure (i.e. gaps around doorways, windows, air vents, tiles on roof etc.)

FLASHOVER

In a compartment fire there can come a stage where the total thermal radiation from the fire plume, hot gases and hot compartment boundaries causes the generation of flammable products of pyrolysis from all exposed combustible surfaces within the compartment. Given a source of ignition, this will result in a sudden and sustained transition of a growing fire to a fully developed fire. This is called flashover.

Signs and Symptoms of a Flashover

Flashover is a sudden transitional stage of the development of a fire in a ventilated compartment, just prior to the compartment being fully developed in fire.

Symptom - ventilated compartment. If there is insufficient ventilation in the compartment, flashover cannot occur as the lack of oxygen will restrict the fire development.

Internal signs:

- **Ventilated compartment**
- **Flames visible in the fire gases.** As the fire develops and more flammable gases are produced by incomplete combustion and pyrolysis, the flames will increase in length as more oxygen is required for combustion to occur.
- **Combustible materials gassing off due to pyrolysis.** As the fire develops in the compartment and the temperature rises, radiated heat will increase onto the combustible contents causing them to gas off due to pyrolysis.
- **High temperatures, speed of combustion.** As the flames increase in size and develop into the ceiling, heat output increases, raising the temperature at ceiling level; the higher the temperatures, the faster the speed of combustion and the more rapid the spread of fire throughout the compartment.



- **Neutral plane moving down.** As the development of the fire increases, so does the production of fire gases. If the fire produces fire gases quicker than they can escape from the compartment, the neutral plane will be forced down.
- **Sudden increase in development of fire.** As the development of the fire approaches the commencement of flashover, the fire will suddenly increase in speed. This is caused by the large amount of heat being given off by the fire, producing large quantities of gases by pyrolysis. These gases will quickly rise and ignite, increasing the heat output from the fire, increasing the development.
- **Pyrolysis at floor level in the compartment.** As the development of the fire approaches the commencement of flashover, the heat output from the fire will be so great that pyrolysis can occur at floor level. When all exposed flammable surfaces (i.e. carpet) are gassing off due to pyrolysis, flashover is commencing.

The signs listed above are a progression of events and some may not be visible for various reasons, i.e.:

- Flames visible in the fire gases** – if the fire gases are very dense, the flames may not be visible.
- Pyrolysis** – if light levels are very low in the room (due to dense fire gases or lack of sunlight), the gases produced by pyrolysis may not be visible.

If firefighters observe the neutral plane descending when they are in a room, they must either:

- Control the development of fire by the application of water, or**
- Withdraw from the compartment.**

Otherwise, they are in danger of being involved in a flashover/fully developed room fire.

FIRE GAS EXPLOSION

This phenomenon is more common than you might expect.

A fire occurring in one compartment may grow steadily creating an over rich environment. In time, depending upon construction, the gases may leak to other compartments. This can continue until an ideal mixture is achieved.

An ignition source such as a gas boiler would create ideal conditions for a deflagration.



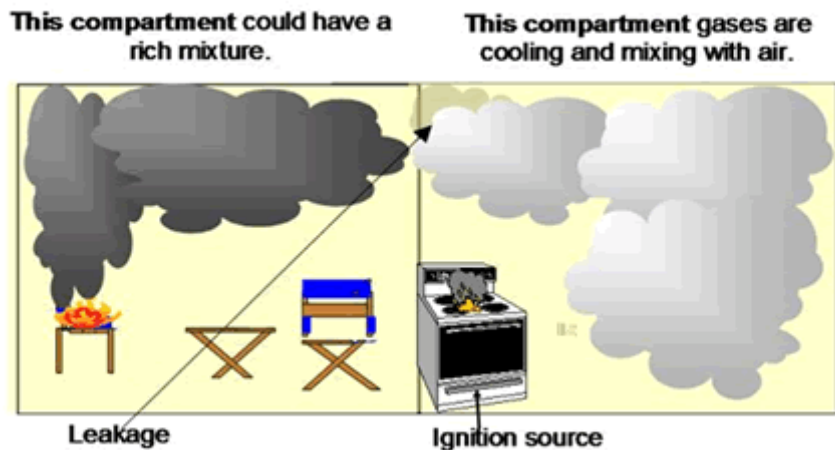

Door opening procedure

Door procedure

When a door is opened to a compartment on fire, the increased ventilation through the open doorway may abruptly change the development of the fire. The increase in ventilation may cause the fire to develop rapidly into a flashover, or backdraught. However on many occasions firefighters will have no alternative than to open the door, before they can determine the conditions inside.

If the following simple procedure is adopted, gaining entry to a compartment poses a minimum risk to firefighters:

- i) Before opening the door, make sure the compartment you are in is "safe" and will not become involved in fire when the door is opened. (See procedure on moving between compartments.)
- ii) Get in a safe position prior to opening the door, keep low and use the wall and door to afford maximum protection when the door is opened. (See pictures on the next page for inward and outward opening doors.) The team leader should stand by ready to operate the branch, while the second member of the team is ready to open the door at the request of the team leader.
- iii) Check branch for operation and set spray width to approx. 20°, ready to carry out a temperature check.
- iv) Check conditions around the door for as much information as possible. Is there charring at the top of the doorway? Are fire gases being forced out under pressure from the gaps around the door? Are the doors hot?

- v) When ready, on the instructions of the team leader, Second member of the team cracks the door open (approx. 300 mm), Team leader very quickly looks into the compartment to assess the conditions inside for appropriate action.
Do not hesitate to instantly apply water and/or close the door.
- vi) Immediately carry out a temperature check through the cracked doorway to:
- Check temperature inside the compartment,
 - Cool and dilute fire gases inside the doorway.
- The water should be applied into the ceiling area just inside the doorway.
- vii) Before the door is opened any further the team must be sure that:
- The signs and symptoms do not indicate a potential backdraught
 - The temperature inside the compartment is cool enough to open the door further and carry out extinguishing techniques.

Picture showing a team leader carrying out a temperature check through a door cracked open

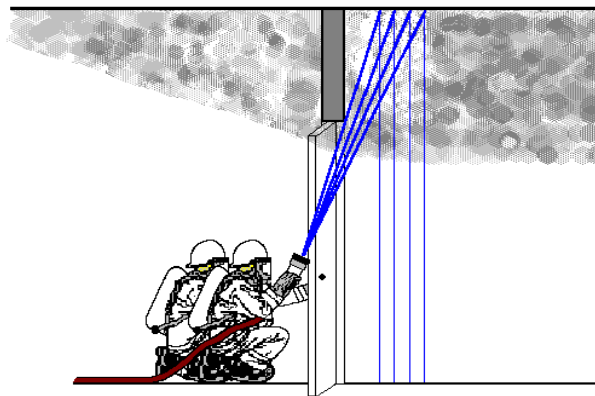

Picture showing a team in position ready to open door

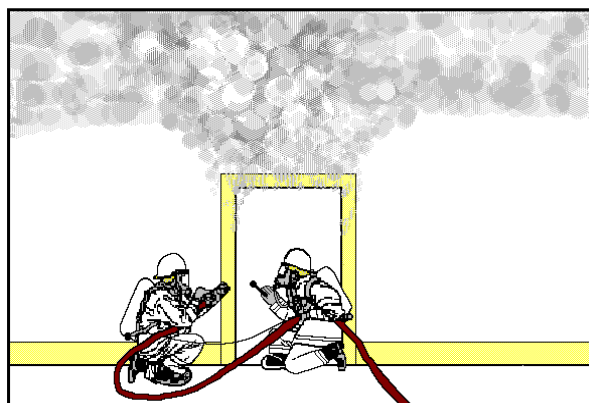

Picture showing a team quickly check conditions inside the compartment and then immediately carry out a temperature check

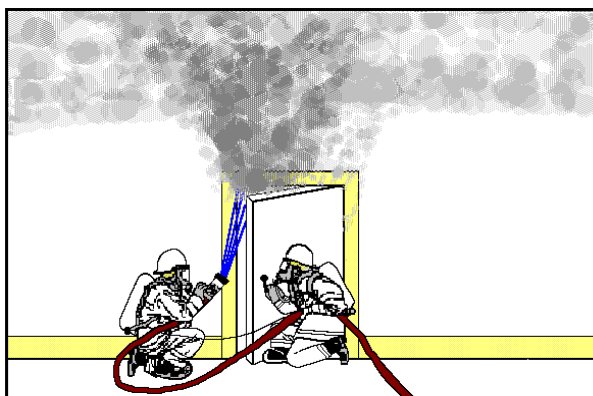

Drawings illustrating a team carrying out a temperature check prior to entering a room with an outward opening door

Picture showing a team in position ready to open door

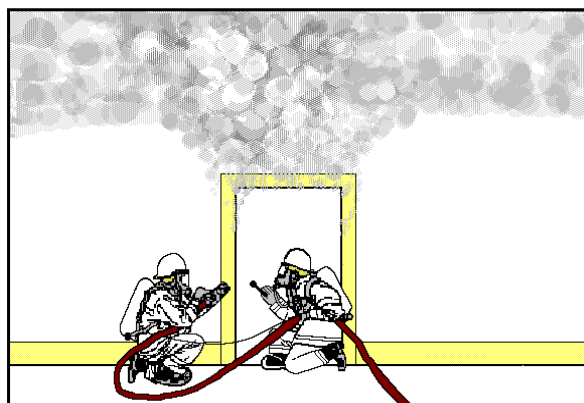

Picture showing a team quickly check conditions inside the compartment and then immediately carry out a temperature check

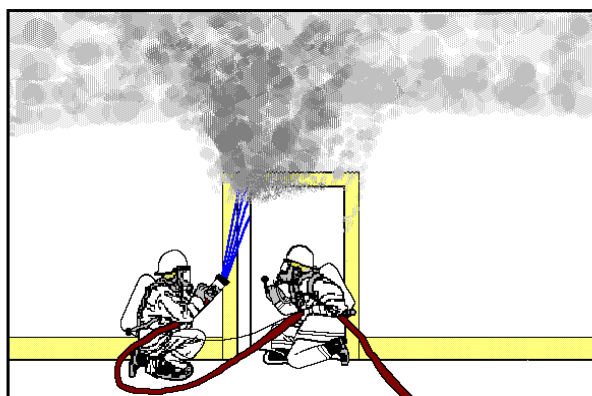

Drawings illustrating a team carrying out a temperature check prior to entering a room with an inward opening door

The procedure described provides the team with a safe method of opening the door to a compartment involved in fire (or containing fire gases from another compartment on fire.)

The main purpose is:

- i) to give both members of the team maximum protection from a possible flashover/backdraught,
- ii) to enable the conditions (development of fire) inside the compartment to be quickly assessed,
- iii) to have the ability to immediately carry out extinguishing techniques.

Shown in the previous examples are positions for team members to safely open the door to a compartment on fire. However, these positions may not always be possible, due to the internal layout of the compartment the team are in. By using the principles described above, firefighters will have to use their ingenuity to adapt to each situation.

BRANCH TECHNIQUES AND GAS COOLING

EXTINGUISHING METHODS

Extinguishing methods can be grouped under three main headings:

- **Gas Cooling**
- **Indirect**
- **Direct**

GAS COOLING METHOD

The spray is aimed directly into the hot fire gases, but does not reach the boundaries of the compartment or its contents (only cools the fire gases). The small droplets of water pass through the hot fire gases rapidly cooling and contracting them. As the water evaporates into steam (inert gas) the fire gases will be diluted by the addition of the steam, and as they cool down they will become more difficult to ignite (require a larger ignition source, with more energy).

Purpose

Cool and dilute the fire gases.

Protects firefighters by reducing the heat output from the hot fire gases and by extinguishing the flames above the neutral plane.

Spray setting - wide to narrow setting

Dependant on a number of factors:



- i) Size of the compartment.
- ii) The depth of penetration required. The deeper the penetration required (to cool the fire gases/extinguish the flames) the narrower the spray width.
- iii) The size of the fire. As the heat output from the fire increases, the spray width will have to be narrowed, otherwise the water will turn to steam before it has sufficient cooling effect on the fire.

Length of pulsation

Dependant on the size of the fire, as the heat output from the fire increases the length of pulsation will have to be increased, otherwise the majority of the water will turn to steam before it has penetrated the fire.

If a narrow spray width is required to penetrate the fire gases and the full width of the compartment is not being cooled, the aim of the branch spray will have to be quickly alternated to cover the full width of the compartment. This is to ensure that flames/hot fire gases do not penetrate towards the firefighters through the area not being gas cooled. If firefighters apply water skilfully, they can maintain the balance between sufficient water to control the fire, with minimal amounts to keep them below the neutral plane. However, this should not be to the detriment of their own safety, if they are unable to control the conditions should immediately withdraw.

If they are able to control the conditions and maintain their vision, they will be protected from the heat above the neutral plane.

Gas Cooling on a wide spray setting

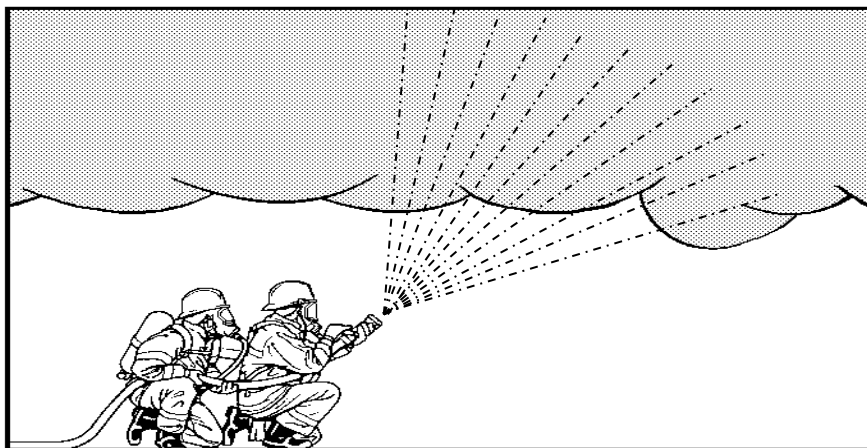

Gas Cooling on a narrow spray setting

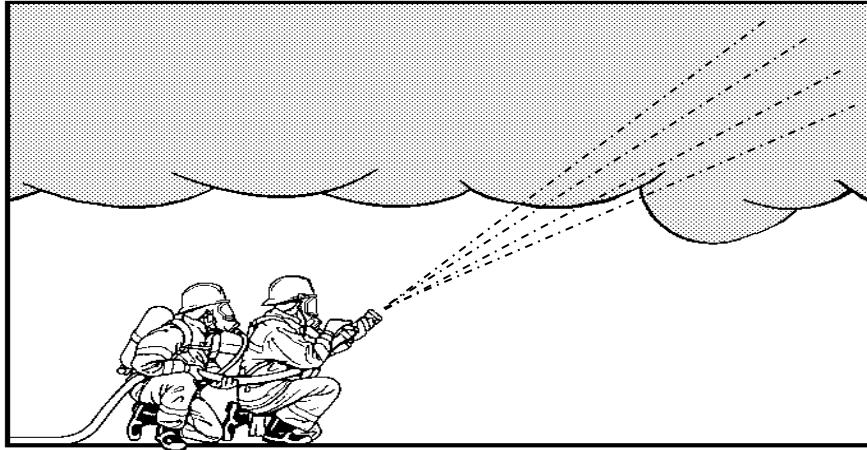

INDIRECT METHOD

The spray is aimed directly into the fire gases and at the hot compartment boundaries. The small droplets of water pass through the hot fire gases rapidly cooling and contracting them and penetrate onto the ceiling and walls reducing their temperature. As the water evaporates into steam (inert gas) the fire gases will be diluted by the addition of the steam and they will become more difficult to ignite (require a larger ignition source) as they cool down. As the hot compartment boundaries are cooled down the heat retained in them reduces, slowing down the production of flammable gases by pyrolysis. When the water spray hits the hot walls and ceiling it will turn to steam more easily, as energy is imparted to the water (heating it) when it hits the ceiling/wall with force, therefore requiring less energy to turn it to steam.

Purpose

Cool and dilute the fire gases.

Cool compartment boundaries.

Protects firefighters by reducing the heat output from the hot fire gases and by extinguishing the flames above the neutral plane. It also reduces the heat retained in the ceiling/walls of the compartment and reduces/stops the further production of gases by pyrolysis.

Spray setting - wide to narrow setting

Dependant on a number of factors:

- i) The size of the compartment. The wider the compartment the wider the spray width, the higher the ceiling the narrower the spray width (to penetrate to the ceiling).
- ii) The depth of penetration required. (i.e. fire on far side of compartment). The deeper the penetration required (to cool the fire gases/compartment boundaries and extinguish the flames) the narrower the spray width.

- iii) The size of the fire. As the heat output from the fire increases, the spray width will have to be narrowed, otherwise the water will turn to steam before it has sufficient cooling effect on the fire.

Length of pulsation

Dependant on the size of the fire, as the heat output from the fire increases the length of pulsation will have to be increased, otherwise the majority of the water will turn to steam before it has sufficient cooling effect on the fire.

If a narrow spray width is required to penetrate the fire gases/compartment boundaries and the full width of the compartment is not being cooled, the aim of the branch spray will have to be quickly adjusted, to cover the full width of the compartment. This is to ensure that flames/hot fire gases do not penetrate towards the firefighters through the area not being indirectly cooled.

The indirect method will produce more steam than the gas cooling method, because the hot compartment boundaries are also being cooled and therefore more water (steam) is required. Firefighters must always try to ensure that all the water turns to steam before it hits the floor. The ability to maintain the balance between sufficient water to control the fire, but minimal amounts to keep the firefighters below the neutral plane, will require greater skill than gas cooling because more steam is produced, lowering the neutral plane.

Indirect method on a wide spray setting

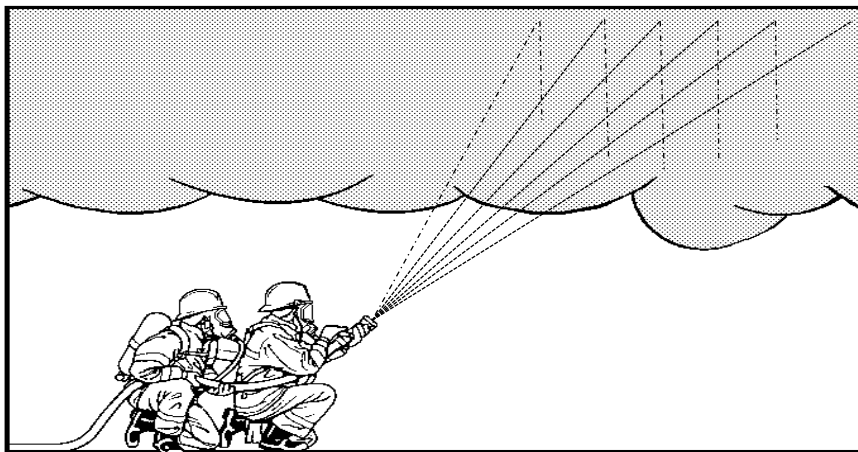

Indirect method on a narrow spray setting

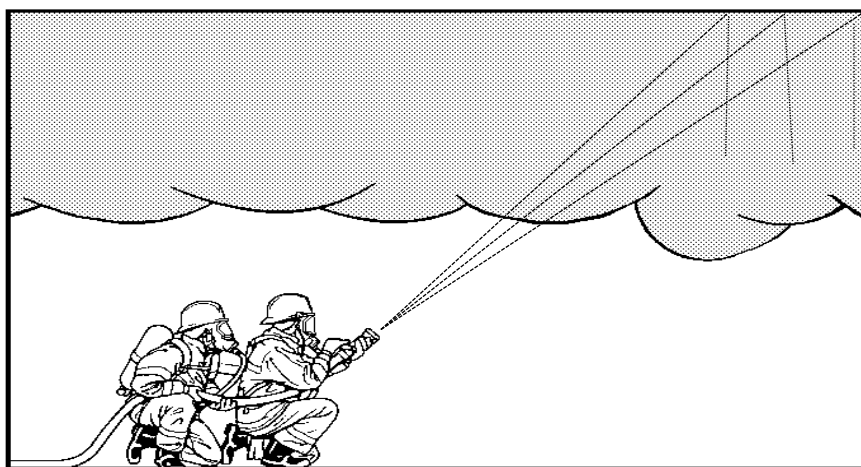

DIRECT METHOD

The branch is just cracked open, so water can be sprinkled onto the contents of the room. (It can also be used on the walls if they are made of flammable material i.e. timber.) If used properly, it will ensure the items cooled will not continue to produce flammable gas by pyrolysis. It should be used as soon as the fire gases in the immediate area have been controlled and before firefighters advance past any items/contents that have been involved in the fire.

When firefighters are moving about a compartment, care should be taken to avoid stirring up embers into the fire gases that may have the potential to ignite them.

Purpose

Cools contents of the compartment.

Extinguishes the fire in its final stages.

Protect firefighters by cooling the contents of the compartment as required to prevent their re-ignition and the further production of flammable gases by pyrolysis, ensuring their exit route remains safe.

Spray setting - wide to narrow setting

Dependant on how far the water needs to be projected and the size of the area to be cooled/extinguished - the larger the item the wider the spray width and the further the area from the branch operator the narrower the spray.

Length of pulsation

Dependant on the amount of cooling required/size of the fire - the more heat retained in the item being cooled/extinguished the longer the pulsation required (more water to cool the conditions).

Direct method

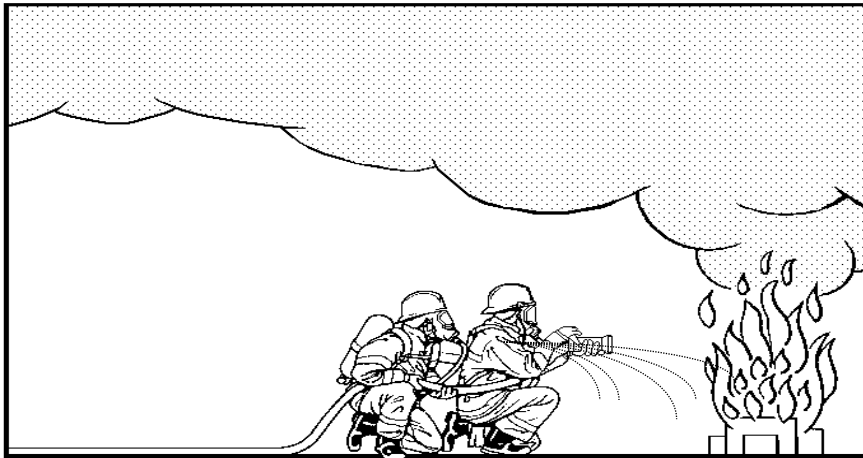

ARRIVAL AT AN INCIDENT

When arriving at an incident as much information should be obtained as possible, prior to entering the building/ship to enable firefighters to appraise the possible dangers:

- i) Layout of building/ship, size and location of compartments, location of exits staircases etc.
- ii) Location of possible casualties.
- iii) Content of compartments regarding fire loading, i.e. timber, plastics, rubber, flammables etc.
- iv) Location and size of fire, last time area was checked (i.e. how long could fire have been burning).
- v) Ventilation to building/ship.

It is not always possible to obtain all of this information, but it may be found from:

- i) Local knowledge of firefighters, previous visits etc.
- ii) Observation by firefighters on arrival.
- iii) Occupant of building, member of the public.
- iv) Predetermined information, fire plans, (information on building, fire loading and occupancy) carried on appliances, etc.

RADIO COMMUNICATIONS

It is essential that a team entering the building/ship have radio communications, so the team can update the Incident Commander of the conditions within the building.

EXTINGUISHING A VENTILATED FIRE

A fire that has plenty of air and is still burning freely could occur in two possible ways:

1. A fire burning in a ventilated compartment.
2. A fire burning in a compartment with restricted ventilation, but because the fire has only been burning for a short period of time, there is still plenty of air remaining in the

compartment to allow it to burn freely. Firefighters opening the door would then allow the fire to develop as a ventilated compartment.

Providing there is sufficient fuel and ventilation, both of these scenarios would develop through flashover into a fully developed room fire.

To safely extinguish a fire in a ventilated compartment, firefighters must apply the following procedures:

1. Carry out door procedure at the door to the compartment.
2. When the door is cracked open, observe the signs and symptoms of a flashover. (The team may already be aware of development of the fire, by observing conditions outside.)
3. If conditions dictate, enter the compartment whilst using extinguishing techniques. As the contents of the room are extinguished and the team move forward, they must ensure that any combustibles are sprinkled with water to prevent pyrolysis/re-ignition and provide a safe exit.
4. If conditions are too severe, then extinguishing techniques should be carried out through the doorway, using the wall and door for protection. Once conditions have improved, the team can enter the compartment.
5. As soon as the development of the fire is under control, the team should consider venting the fire gases and steam to open air. Ideally this should be directly to open air (i.e. window), but alternatively through an adjacent room to open air.
6. The fire can now be completely extinguished, with all combustible contents damped down, in a greater degree of comfort.

Ventilation should only be carried out on instruction from the Incident Commander and should not be carried out until the fire is under control, otherwise the inrush of air may suddenly increase the development of the fire, endangering the safety of firefighters inside.

If firefighters are unable to control the conditions, they must withdraw to a place of safety. The size of the fire may require a 45 mm line of hose or more than one team, each with a line of hose to control the conditions.

Firefighters do not always have to enter a compartment or carry out firefighting through a doorway; it may be safer to enter or firefight through a window. However all the same principles for a doorway apply to an alternative entry point to the compartment.

EXTINGUISHING AN UNVENTILATED FIRE

If a fire has started in an unventilated compartment, as it develops the air will be consumed. After a period of time the fire gases in the compartment may reach a too rich mixture. If ventilation then occurs (either by firefighters, or by the fire burning through), a backdraught may occur (providing there is an ignition source.)

To safely extinguish a fire in an unventilated compartment, firefighters must apply the following procedures:

1. Carry out door procedure at the door to the compartment.



2. When the door is cracked open, observe the signs and symptoms of a backdraught. (The team may already be aware of development of the fire, by observing conditions outside.)

If a compartment is showing the signs and symptoms of a backdraught, teams should not enter, as the risk to the team of a backdraught developing when they are inside is too high.

3. The team must carry out the initial firefighting from outside the compartment to:
 - i. Dilute the too rich mixture with a large volume of steam (inert gas), until the fire gases are below their flammable range.
 - ii. Cool the fire gases, making them more difficult to ignite.
 - iii. Smother with steam any possible ignition sources.

Applying water through the doorway, the water should be applied into both the over pressure (cool and dilute the fire gases) and the under pressure (using the natural flow of air). The water spray is entrained deep into the compartment. The entrained water can travel to the seat of the fire to smother any ignition sources, where it will rise with the natural currents into the hot fire gases and turn to steam.

Picture illustrating water being applied into an unventilated compartment from outside

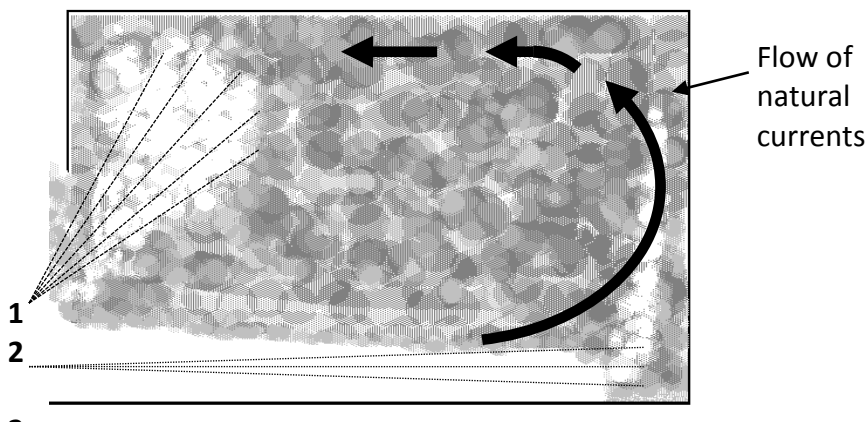

Water is applied into the over pressure (1), to cool and dilute the fire gases. Water is also applied into the under pressure (2). Using the natural flow of air the water spray is entrained deep into the compartment. The entrained water can travel to the seat of the fire, smother any ignition sources, where it will rise with the natural currents, into the hot fire gases and turn to steam.

Extinguishing through the doorway can be applied by two different methods:

1. Open method
2. Closed method

OPEN METHOD

The door is left open all the time and pulsations of water are applied through the opening. The amount of water applied will depend on the heat (energy) retained in the compartment.

Disadvantages of this method:

- If the firefighters carrying out the extinguishing techniques are inside the building, the diluted hot fire gases and steam will be venting into the same compartment as the team. If this compartment is not well ventilated the team may suffer unnecessary punishment.
- The extinguishing techniques may not be able to penetrate the compartment as effectively as the closed method.

CLOSED METHOD

Pulsations of water are applied through the doorway, which is then immediately closed. After the over pressure inside the compartment has died down, the process is repeated. The amount of water applied will depend on the heat (energy) retained in the compartment.

An advantage with this method is the hot fire gases and steam remains in the compartment. The steam is also a more effective extinguishing agent, because it cannot escape from the compartment and therefore penetrates into all areas more effectively.

A disadvantage with this method is if large quantities of water are applied very quickly, the increase in pressure in the compartment may break already weakened windows/compartment boundaries.

As the team is applying water through the doorway, they must constantly observe the fire gases exiting at the top of the doorway (most concentrated), to ensure they are diluted with steam.

As the fire gases cool down and dilute, the amount of water being applied can be reduced. It is always better to apply too much water, rather than risk a backdraught occurring.

Once the fire gases inside a compartment have been cooled, diluted and brought under control (so a backdraught will not occur), the compartment must be ventilated quickly to release the heat and steam from the compartment otherwise it might re-develop. Ideally this should be directly to open air (i.e. window), but alternatively through an adjacent room to open air.

As soon as conditions permit, enter the compartment whilst using extinguishing techniques.

As the contents of the room are extinguished and the team moves forward, they must ensure that any combustibles are sprinkled with water to prevent pyrolysis/re-ignition and provide a safe exit.

The remnants of the fire can now be completely extinguished, with all combustible contents damped down, in a greater degree of comfort.

Ventilation should not be carried out until the fire is under control, otherwise the inrush of air may suddenly increase the development of the fire, endangering the safety of firefighters.

If firefighters are unable to control the conditions they must withdraw to a place of safety.

The size of fire may require a 45 mm line of hose or more than one team, each with a line of hose to control the conditions.

Firefighters do not always have to carry out firefighting through a doorway; it may be safer to firefight through a window. However all the same principles for a doorway apply to an alternative entry point to the compartment.

MOVING BETWEEN COMPARTMENTS

When firefighters are dealing with a fire in a building/ ship with more than one compartment, there will always be a danger when a doorway is opened between two compartments. The fire from one compartment could develop into a second compartment by:

- i) Heat from the compartment on fire passing into the adjoining compartment and initiating pyrolysis.
- ii) A backdraught in one compartment developing through an opening(s) into another compartment.
- iii) Ignition source from the compartment on fire moving through the doorway and igniting leaked fire gases in the adjoining compartment.

Before firefighters open the door to another compartment, they must ensure the compartment they are in will not become involved in fire when they open the door.

This can be achieved by:

- i) Cooling the fire gases (that have leaked through from the fire) in the compartment by using the correct extinguishing techniques.
- ii) Ventilate diluted fire gases to open air. This may not always be directly possible, but it may be feasible to ventilate to open air through a second compartment, (see ventilation techniques).
- iii) If unable to ventilate properly, suspend fine droplets of water in the atmosphere, as sometimes the fire gases may not be hot enough (below 100°C) to turn the water to steam when carrying out gas cooling. If fine droplets are suspended in the cool fire gases, when the door is open any heat coming through will turn the water droplets to steam. This will reduce any chance of ignition.
- iv) Sprinkle water on any combustibles, particularly around the doorway and ceiling. This will prevent heat from coming through the doorway and causing pyrolysis in the room the team are in.

This systematic approach must be carried out before opening a door to another compartment.

SHIP FIREFIGHTING TECHNIQUES

ORGANIZATION ON BOARD

The general organisation chart is as follows:

Ship's Master:

The Master is responsible for the ship and therefore also for emergency activities

Chief Security Officer (on deck)/Chief Engineer (in engine room):

The Security Officer is the Coordinator and officer responsible for "on-site" fire-extinguishing operations

As there is a larger crew on board **passenger** ships, the fire service approach involves training of an emergency management group formed by the heads of the various sectors, normally on the main deck and an assessment team, with initial response tasks, control of the disaster area and coordination of operations.

Among the tasks that can be organised and arranged by the members of the assessment team in the event of a fire, are those related to the initial assessment, confinement of the fire and verification of "exposures".

During an on board emergency, the need arises to create an integrated and coordinated system to share information and assess the options to manage the emergency. The importance of communication is even more evident considering that there are fundamental operations to the on-board systems that can be carried out from the bridge or the engine room. If these operations are not coordinated they can create problems for the operating personnel and/or for the entire ship.

If significant quantities of water are used for the extinguishing operations, information on the stability of the ship is essential.

The Security Officer must constantly inform the bridge about the situation of the fire so that the Ship's Master can make the correct decisions regarding the safety of the ship.

Let's see what the emergency management aids are:

MUSTER LIST: this is a list of actions to be put into practice for each crew member for the 4 main emergencies on board a ship:

Fire, Damage, Man at sea, Abandon ship

FIRE PLAN: shows the position of all fixed and mobile firefighting devices on board a ship. The plan must be located in a well-visible watertight red tube at the main entrances of the ship and on the bridge. It is extremely important for the Fire and Rescue Service teams who are deployed on board.

PLAN OF LIFE-SAVING APPLIANCES: this is a list of rescue equipment and appliances of a ship in the form of a plan displayed in the main corridors of each bridge. It can be



used to find an alternative exit in case of abandoning the ship.

In the event of a fire on board a ship at sea, the Muster List is implemented and, as can be seen, the Chief Officer is responsible for emergency operations relating to fires on board the ship, except for the engine room, which is covered by the Chief Engineer, who:

- is present in the immediate vicinity of the fire
- has contact with the teams
- makes operational choices
- gives instructions to emergency teams

The Ship's Master is tasked with managing the emergency as a whole, therefore, on the basis of the information reported by the person in charge of the rescue operations, he/she will decide what actions need to be taken with the aim of "SHIP SAFETY ". For example, these can be:

- head towards a port of refuge
- ask for external help
- use saturation extinguishing systems (CO₂)
- gather passengers at assembly points
- give the order to abandon ship

Ships, especially passenger ships, may have multiple emergency teams; large cruise ships can have up to four, each with different tasks and/or areas of expertise. They are divided into attack and support teams.

Attack teams immediately gather in their firefighting station, wear the appropriate equipment and go to the designated area to take over from the personnel who carried out the first fire-containment operations, and then organize the firefighting operations.

The teams are led by experienced officers with excellent knowledge of the ship.

The support teams on the other hand go to their own firefighting stations, they equip themselves and inform the Bridge as soon as they are ready.

Their task will be to contain the fire, cool the outlying areas and provide the attack group with all the necessary material in the fire area.

On a ship with more than a thousand crew members there may be two attack teams consisting of 5-6 operators each and about 30 other operators for the support teams.

SPREAD OF FIRE IN SHIPS

The most important factors, which a spreading fire depends on are:

- Nature and mutual distance of the objects contained in the room subject to thermal radiation;
- Type of coatings on the surfaces of the room (floor, walls and ceilings);
- Room size;



- Location of the source of ignition with respect to the bulkheads, door and any ventilation openings (portholes, windows);
- Opening status of the door and any windows (ventilation conditions)

A fire in a closed environment, as we have already seen, causes a progressive increase in pressure. The gases produced by combustion therefore seek an escape route out of any available hole. Hot smoke, which conveys two-thirds of the heat generated by the fire, once it has out-rushed the room, it dries and preheats materials that have not yet been affected by combustion. Combustion occurs when these reach their self-ignition temperature. The phenomenon is accelerated if these materials are subjected to direct irradiation of the flames. Ultimately, smoke overpressure causes it to **spread horizontally**. Due to the high temperature and different density compared to fresh air, smoke rises rapidly and can ignite any combustible material present along the way. The different density of smoke with respect to air therefore causes it to **spread vertically**.

In short, two factors influence the direction of smoke/fumes:

- thermal expansion due to the increase in temperature and pressure of the gases following the fire;
- upward forces generated by the difference in density of hot gases above the fire and that of the external air feeding the fire.

It is therefore of fundamental importance to prevent the movement of the fumes through the vessel by firefighting compartmentalisation.

Firefighting compartmentalisation is implemented by automatically closing the fire doors directly from the bridge or locally, if necessary.

For the ducts of the ventilation/air conditioning system, which connect most of the rooms to each other, the halls, stairwells and elevator, the use of fire dampers is essential.

After having closed the fire doors, the ship is divided into various “vertical compartments”.

The steel bulkheads prevent radiation of the fire, slowing down the heat that spreads by conduction and the advancing of the fumes, but they cannot block them completely. All the rooms of the same vertical compartment in which the fire occurs, are therefore to be considered at risk. The spreading of fire within the same compartment will be limited by the timely response of the firefighting teams.

On ships that do not have an independent ventilation/air conditioning system from compartment to compartment, the involuntary transfer of fumes from one compartment to another must be avoided by stopping operation of the installation.

A problem that exists on a ship is the limited presence of natural ventilation openings, which are generally portholes or windows, mostly present in the superstructures; therefore, most of the closed areas/rooms of a ship either have no opening outwards or it is very limited. These conditions do not allow smoke and heat to exit and frequently determine a situation of asphyctic combustion.



In addition, most interior rooms of a ship have a limited deck-deck height. This is another construction characteristic that makes the environmental conditions of a room affected by fire severe in a short time.

The development of a fire in any room of the ship activates the fixed automatic firefighting system with spray or nebulised water (sprinkler or hi-fog); however this always results in the formation of water vapour in the environment, with a consequent reduction in visibility and a further deterioration of the environmental conditions.

When possible (e.g. room with open-air openings) natural ventilation can be used. This must be undertaken as soon as the teams are ready to enter into action.

A special case can be given by external cabins with balcony. Smoke and heat generated by a fire in such environments could easily find an outrush by opening the external glazing to limit the development of heat within the cabin and reduce spreading by conduction. Nevertheless, particular attention should be paid to ensuring that smoke or any flames emitted outside do not affect other adjacent cabin rooms or rooms on higher decks, also considering the true or apparent wind that influences the direction of the smoke.

In the event of fire in the engine room, in the presence of combustible liquids, oils and the like, there is an immediate development of thick dark smoke. It is therefore important that the person making the first assessment of the fire takes this fact into account, remembering that any CO₂ discharge prevents use of propulsion engines and generators.

In such situations, it is essential to use foam as an extinguishing agent, as it is ideal for flammable liquid fires. In fact, in addition to the greater effectiveness on flammable liquids, the advantage of foam is that it has less influence on the stability of the vessel compared to water as well as a persistent extinguishing action, after covering the pool of ignited liquid.

As to operator safety, not to be overlooked is that many combustion products can be absorbed through the skin, especially in the neck and wrist areas. For this reason PPE and BA (i.e. self-contained breathing apparatus) must be adopted.

In addition, these combustion products make it very difficult to carry out a rescue and extinguish flames due to the reduced visibility and physical stress exerted on the operating personnel.

Finally, the fumes must always be considered as a fuel in solid and gaseous form for unburnt fuels present in them in such physical conditions; therefore the danger lies above all in their ability to ignite and/or explode.

Also to be borne in mind is that statistically smoke and hot gases kill many more people than flames.

VENTILATION PROCEDURES AND SMOKE CONTROL

By ventilation we mean the action aimed at facilitating the exit of the combustion products outside.

It is known that most of the victims of a fire die due to asphyxiation or poisoning caused respectively either by the lack of oxygen or toxicity of the gases produced by combustion.



During a fire, even before the smoke or heat become evident and manifest, carbon monoxide and other extremely harmful gases are introduced into the compartment, which could be lethal for people without appropriate protection.

USE OF VENTILATION FOR SMOKE CONTROL

With prompt and adequate ventilation, the smoke and heat can be conveyed away from people and fuels that have not yet been involved.

Masters generally deal with a fire by using the on-board equipment, trying to confine it as much as possible, as direct intervention could result in losing control with consequences that could prove even more serious.

PRIORITY TO BE FOLLOWED FOR VENTILATION

As a matter of principle, not ventilating and segregating the fire on board ships must be a priority that is also followed by the Fire & Rescue teams, unless there is the need for a direct attack to protect human life or the integrity of the ship (e.g. fire in the engine room or the bridge).

The best type of ventilation that can be implemented is natural ventilation, as it releases the fumes in overpressure from the burned rooms without bringing air to the seat of the fire.

Forced mechanical ventilation can lead to high risks if applied badly.

In general, mechanical forced ventilation should only be used to facilitate natural ventilation.

If ventilation can only be carried out mechanically, make sure that the ventilation ducts and fans are able to withstand the temperature of the smoke that passes through and that the smoke comes directly out into the atmosphere without spreading the fire to unaffected rooms or areas.

If necessary, it is preferable to extract the smoke, as it ensures the removal of dangerous fumes stratified at the top, allowing any combustion to take place outside, whereas ventilation brings in fresh air that could fuel the fire.

To reiterate, ventilation pushes unburnt gases and makes the combustion phenomena worse at the point of exit into the open air.

To coordinate the ventilation operations it will be necessary to use the officers on board.

No fire should be ventilated if the attack/protection water lines are not yet available.

TYPES OF VENTILATION

Natural vertical ventilation

In an ideal situation, the combustion gases are vented from openings immediately **over** the fire, while the extinguishing agent is applied directly to the seat of the fire.

This situation, which is typical of industrial buildings, is almost impossible to verify on board, since there is hardly any vertical way out.

Natural horizontal ventilation

This type of ventilation is achieved by **first** opening the doors located leeward and **then** the windward ones.



The fresh air that is introduced into the windward door pushes the combustion fumes out through the leeward openings.

Never open windward doors alone or first!

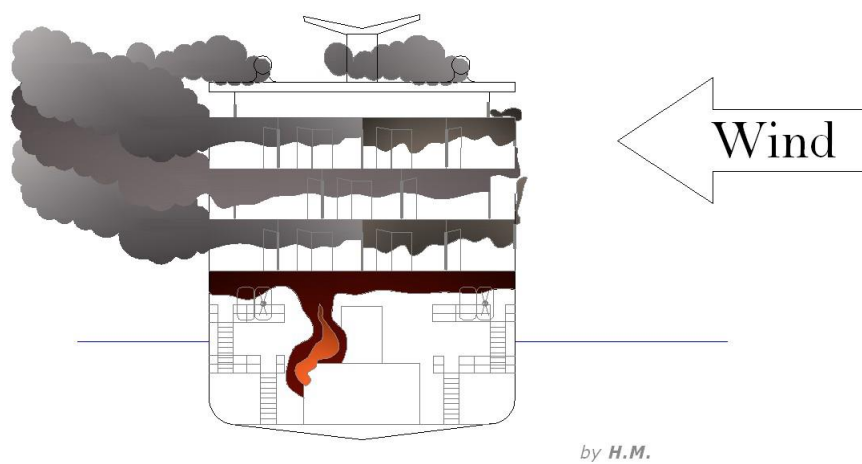
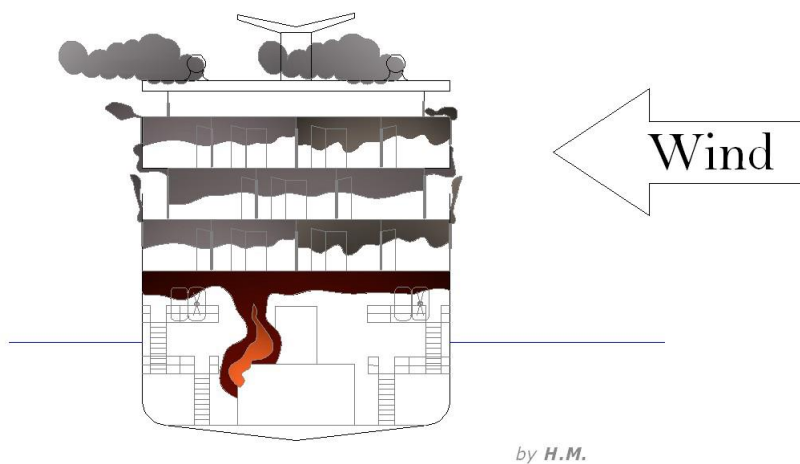

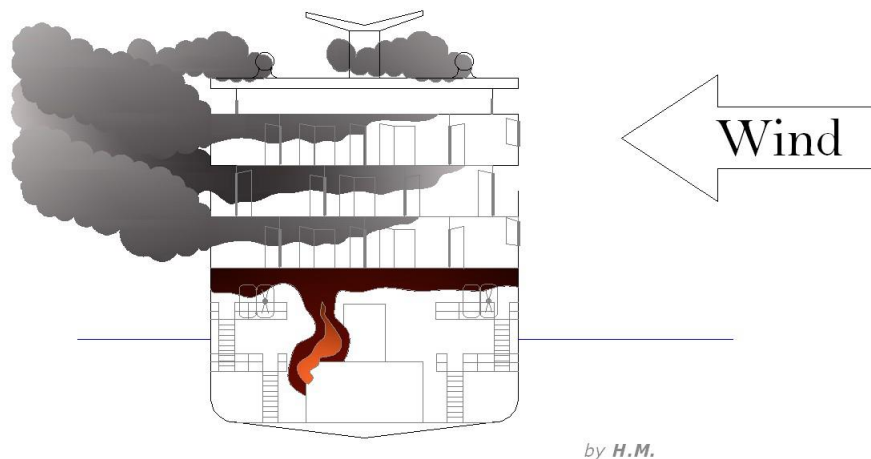

Combined natural vertical and horizontal ventilation

In many cases a combination of vertical and horizontal ventilation may be useful. A horizontal flow of air can be created on a hatch located on the bridge immediately above the fire. This air movement will produce a "Venturi effect" that is capable of extracting smoke and heat. A portable fan will accelerate the air movement. Doors to unaffected areas should always be closed until the ventilation has been completed so that the contaminated air is confined.

Mechanical ventilation

The purpose of mechanical ventilating techniques is to convey combustion products so as to create a "circulation" that allows the teams to enter from one side and the fumes to exit from another.

Positive/negative mechanical ventilation

There are two types of mechanical ventilation that can be put into practice:

- PPV – positive pressure ventilation (*ventilation*)
- NPV – negative pressure ventilation (*extraction*)

The use of the techniques briefly described above requires prior in-depth practical training conducted by qualified instructors in the matter; any attempt to follow these techniques without having carried out the training can not only be ineffective but also potentially dangerous.

The difficulties increase during navigation, as in addition to the firefighting problems there are those related to steering the vessel. In this case the weather conditions greatly influence the effectiveness of the operations.

A further difficulty is found on cruise ships due to the large number of people involved, creating what is currently the most complex problem to be addressed for those involved in sea rescue, namely MRO, Mass Rescue Operation.

No rescuer who reaches the ship from outside can operate with the same effectiveness as the "emergency teams" on board, if they are not properly instructed and trained.

The main aspects to be taken care of to guarantee the effectiveness of the operations of the Fire & Rescue Services are to:

- get into immediate contact with the ship's Master
- create a command post together with the Ship's Master;
- support the crew in the firefighting operations
- monitor and make sure that the ship's condition is continuously monitored by the crew;
- maintain contact with the Maritime Authority (responsible for operations).

ASSESSMENT AND INITIAL RECOGNITION

The NAMIRG Operations Commander (OC) must be able to process all the information obtained from third parties and those acquired personally during the survey to develop a plan that will have the following tactical priorities:

- a) rescue
- b) fire containment

The NAMIRG OC should determine the following elements necessary to establish an attack strategy, as soon as possible:

- the class of fire (what kind of combustible materials are burning)
- the most suitable extinguishing agent (water, foam, CO₂, etc.)
- the operations to be carried out to contain the fire and, if necessary, the need for a direct attack;
- the human resources available and the related firefighting tasks.

EMERGENCY ASSISTANCE AND RESCUE

Rescue is the "operational" priority in the sequence "reconnaissance, rescue, fire extinguishment, and make places safe" to be adopted for each fire. Rescue may be the first activity of the operation or it may be delayed due to adverse circumstances, such as someone being trapped in a compartment located within the area affected by the fire. If some firefighters are able to go beyond the fire while others attempt to control it, rescue can be carried out immediately. If the fire cannot be controlled easily, it may be preferable to control the fire before attempting the rescue.

TRANSFER OF CASUALTIES ON BOARD THE VESSEL

In the event of an emergency, it may be necessary to move people who are injured or unable to move independently from the site of the fire.

Several transfer methods to be adopted are outlined below, if there is only one rescuer to move healthy or injured people from the danger zone to the nearest safe area.



As soon as the safe area is reached the medical transfer methods should be applied, such as the use of backboards, various types of stretcher etc.

Firefighter method

This system is used when the rescuer needs to keep one hand free at all times to carry out other operations during transfer (supporting him/herself, opening doors, using firefighting equipment, etc.):

- the casualty must be able to stand even with the help of the rescuer;
- the rescuer grabs the casualty's wrist with his/her hand;
- the rescuer then squats down and brings the casualty's body across his/her shoulders to balance the weight;
- the rescuer then passes his/her arm around the casualty's legs and takes the casualty by the wrist;
- in this way, the rescuer has a free hand.

The drag method

This system is used if a casualty is on the ground and is useful especially if the casualty weighs more than the rescuer:

- the rescuer puts the casualty's hands on his/her abdomen;
- the rescuer grabs the victim's clothes at shoulder level and pulls him without lifting him.

To facilitate move the casualty, we can lay a sheet or blanket under the casualty that will make it easier to slide along. This method only allows horizontal movements.

Method to overcome differences in level

- the rescuer kneels behind the casualty and raises his/her trunk;
- the rescuer cross the casualty's arms on his/her abdomen;
- the rescuer then grabs the casualty's wrists and lifts him/her with the strength of his legs; the casualty's feet will continue to touch the ground
- the rescuer drags the casualty's body to overcome differences in level as well.

To move and rescue casualties in difficult areas, the various SAF methods can always be used.

IDENTIFICATION OF AN AREA TO WAIT FOR MEDICAL ASSISTANCE

This area should be arranged in a smoke-free zone, as close as possible to the area affected by the fire. An ideal location in this respect would be an open deck, windward to the fire. Nevertheless, the waiting area must not be located in a zone that could be threatened in some way by the fire spreading.

DIRECT AND INDIRECT FIRE ATTACK

Before opening a fire door or a watertight cargo port to see if there is a fire, the door (cargo port) must always be checked. To check the temperature of the door and identify the possible seat of a fire, infrared cameras are very useful tools as there is no need to get close



to the structures to be measured and they also provide a quantitative, as well as qualitative, measurement of the temperature.

Once the fire has been detected, the door leading to the fire area must not be opened until a fire hose has been set up.

Direct attack

In the direct attack the firemen advance towards the area directly affected by the fire and deliver the extinguishing agent directly to the fire site.

Operator safety during direct attack

Internationally, a standard has been imposed by the OSHA (Occupation Safety and Health Administration) of the United States of America, concerning the requirements for respiratory protection and the minimum levels of staff to be adopted during the operations to combat fire inside a building or a structure.

Although these standards are not directly imposed in ship fires, many of the requirements and recommendations contained therein can be usefully applied to the maritime field as well.

Essentially these rules state that during a fire, every operation inside a room requires the use of "overpressure" breathing apparatus if the atmosphere of the closed space is considered "Immediately Dangerous to Life or Health" (IDLH).

Furthermore, they set out that during these operations each entry must be carried out by a minimum of two firemen who must be in constant visual or vocal contact with each other. While this internal team is operating, they must be in direct vocal or radio contact with personnel outside the site (NAMIRG Group Leader).

In addition, another team composed of at least two more firefighters outside must be ready in "stand-by" for possible rescue operations. Hence why this is called "2 in 2 out". Possibly added to the "2 in 2 out" there could be a person in charge of monitoring the air reserves of all the operators who are in areas at risk.

Besides the external stand-by team, a replacement team should also be available to take over from the team that is already inside. A ship fire requires an extensive deployment of human resources and in particularly severe conditions frequent replacement of the operating forces is suggested.

In this regard, however, the use of air cylinders with at least hr. of self-sufficiency can be suggested. In ship fires, the arrangement to "change the operator, not the cylinder" seems somewhat more conservative.

In order to be able to do this, NAMIRG OC will have to anticipate the human resource demand right from the first moments to satisfy the many needs that will arise.

Indirect attack

An indirect attack is used when it is impossible for the firefighters to reach the fire site.

This is generally the case when the fire is in one of the lower parts of the ship. The success of an indirect attack depends on the possibility of containing the fire.

Every possible way for the fire to spread must be shut off by closing doors, hatches and stopping the ventilation systems.

One technique consists of injecting a jet of water mist into the burning area, the heat turns the water into water vapour, which suffocates the fire.



There are two important things for an attack of this kind to be successful. First of all, the fire must be completely circumscribed, so that the vapour reduces the oxygen content in the air present (by dilution). Secondly, the fire must be hot enough to allow the water to evaporate.

Another indirect technique employs a suffocating extinguishing agent such as carbon dioxide, for example. The use of this technique is well-known for fighting fires in cargo ship holds, engine rooms and flammable material stores.

USE OF EXTINGUISHING WATER AND STABILITY OF THE SHIP

Water must be used carefully to avoid stability problems.

If large quantities of water are used, especially on the top decks, it can become a considerable problem as the free surface effect is created and raises the vessel's centre of gravity, whilst at the same time, greatly reducing its stability.

To be borne in mind is that the water used during the extinguishing operations is supplied both by the firefighting teams and by the fixed systems, so the quantity used needs to be assessed and efforts should be made to remove such water as soon as possible.

There are many tragic stories of firefighting operations on board ships that lasted for hours, and even days, with the only result of the ship sinking because of the extinguishing water used. These results are frustrating and embarrassing and unfortunately also extremely serious from an economic point of view.

Experience shows that there are three ways to prevent such disasters. The first method, which is certainly preferable, consists in removing all the extinguishing water as soon as possible. The second method is to use as little water as possible. The third is to drain it down to where it is less destabilising, such as in the bilges, which lowers the centre of gravity.

The presence of loads on board a ship, such as extinguishing water or in any case heavy objects that move freely, involves serious risks, such as "**listing**".

"**List**" is when a vessel whose floating equilibrium is stable with a transverse inclination at a "listing" angle.

This situation is extremely dangerous, as part of the ability to counteract the causes of the list (stability reserve) is lost.

The more the weight is added to the top part of the ship, the worse the result of the operation and the greater the problem.

The use of Hi-Fog fixed systems of the significantly decreases the amount of water supplied, and at the same time is more effective.

FIRE IN MACHINERY SPACES

As already mentioned, the "machinery spaces" of a ship, together with the bridge, are part of the vital centre of the ship itself and its operation cannot be seriously penalized unless there is a risk of losing the entire ship or seriously compromising its integrity.



On modern ships, the term "machinery spaces" means a complex and articulated set of many rooms, equipment and systems; from this complexity, as well as the presence of various fuels in a liquid state, there is an objective intrinsic vulnerability of these environments to fire, mitigated by the advanced technologies of control systems, fire detection and automatic extinguishment.

Firefighters who find themselves operating in such areas would have to deal with the additional difficulties of small spaces, heat and smoke and the difficulty in communications. Further problems derive from noise, the presence of live electrical equipment, possible spills of dangerous fluids from machinery, from the complexity of the possible consequences of a fire in these rooms, from the danger of some firefighting systems (e.g. fixed CO₂ system) that are not present in other areas of the ship.

Foam is the most suitable extinguishing agent for fires in the engine room.

EXTINGUISHING FIRE WITH FOAM

The general rules concerning the use of mechanical foam in extinguishing flammable liquid fires, also applicable to fires within ships and in particular in machinery spaces, are as follows:

- When using foam jets or forming foam blankets, the key word is "delicacy";
- Each fire requires a certain duration of foam application. Before starting delivery, check to ensure that there is sufficient foaming liquid;
- Foam does not extinguish a widespread three-dimensional fire; it is necessary to create a collection area for the flammable liquid beforehand;
- There are different types of foaming agents for each type of flammable liquid, some of which are suitable, others are not, and others are ineffective. Foaming agents with special characteristics are generally not required for hydrocarbons and their derivatives; however, they are for alcohols;
- Foam can also be used to cool, because it is also composed of water; it cools inclined or vertical surfaces very well (much better than water);
- Water on foam damages the foam; either one or the other should be delivered, but not both, which is ineffective and detrimental for extinguishing operations;
- The foam layer does not have an unlimited duration and therefore must be reapplied periodically;
- Do not walk on the foam blanket covering a flammable liquid as there is the risk of reigniting, especially if the liquid has a high temperature;
- High expansion foams are affected negatively by wind or strong draughts; their ability to stop evaporation, their durability and resistance to fuels are less than low expansion foams;
- High expansion foams are not recommended for flammable liquid fires while they may be useful for flammable solid fires and in general three-dimensional fires in general;
- Never mix different types of foam in the same tank;



- Pay attention to the wrong combinations between the single foam lance and the various types of line pre-mixers;
- When dispensing the foam, be careful to open the lance shut-off valve completely;
- Be careful not to interpose an excessive hose length between the line premixer and the foam lance;
- Always store foaming liquids in the appropriate containers (many of them corrode metals like standard steel sheet)
- At the end of use, always wash the entire dispensing system thoroughly before putting the various components away so as to avoid corrosion or obstructions.

The use of foam can be particularly effective for flammable liquid spills in deck areas or in wells or in containment boxes in which the ignited liquid is confined and also covered by foam. In any case, the floor of any "technical" room of the ship, which has access hatches instead of doors or gates, can easily be covered with foam up to a certain height without the risk of it overflowing into other areas. Moreover, it will be affected less by the rolling effect of the ship than water and will not cause hull stability problems.

Foam is ideal for extinguishing any bilge fires.

Last, and not least, foam can be useful to preventively cover a flammable liquid spill so as to prevent accidental ignition, until it can be recovered and cleared.

In particular situations, the same use of foam can be made on solid combustible materials that burn and produce embers, in the case in which, after a fire that is under control, it is not possible to proceed quickly with breaking it down.

NAMIRG SOP

NAMIRG SOP 1 - NAMIRG TEAM DEPLOYMENT

PURPOSE

This SOP defines the operations in the event of a fire at sea, how the NAMIRG team is alerted, what information is needed to plan the operations and which figures are involved.

RESPONSIBILITY AREAS AND TASKS

Once the alarm has been received the SMC (Search and Rescue Mission Coordinator) of the MRCC/MRSC (Maritime Search and Rescue Coordination Centre or Sub Centre) responsible for the SRR (Search and Rescue Region) in which the DV (Distress Vessel) is located, who is therefore responsible for the rescue operations will determine the conditions of the ship based on the information in his/her possession, before deciding whether to send the NAMIRG team or not. For this purpose, the control room of the associated Fire and Rescue Service, namely Trieste for Italy, Koper for Slovenia and Pula for Croatia will be contacted to request that an FLO (Fire Liaison Officer) be sent to the MRCC/MRSC as a firefighting consultant.

The contacted Fire and Rescue Service will send an FLO to the requesting MRCC/MRSC.



Once the NAMIRG team has been deployed, the MRCC/MRSC will contact the Fire and Rescue Service control room to:

- Request that an FLO be sent, if not already done so beforehand
- Request that the NAMIRG team be sent
- Provide the necessary information for the NAMIRG team

To ensure efficiency in the NAMIRG operations, it is vital to have sufficient preliminary information on the incident and distress vessel. The key information about the distress vessel is:

- its location
- type of incident
- where it occurred on the vessel
- when it occurred
- actions initiated on board the vessel and results obtained
- condition of the vessel

The Fire and Rescue Service control room contacted by the MRCC/MRSC must alert and provide any data on hand to:

- The control rooms of the other 2 countries, who will in turn alert their on-duty/off-duty operators
- The on-duty NAMIRG operators
- The off-duty NAMIRG operators

The Fire and Rescue Service control room in Pula will also alert the Divulje helicopter base, gathering information on the ETA of the helicopter at Pula airport and also the other Istrian command units of the operators belonging to the NAMIRG team, which in turn will alert the on-duty/off-duty operators.

The Trieste Fire and Rescue Service control room will also alert the Venice Helicopter Command Unit of the possible use of the AB 412 helicopter located there.

The NAMIRG operators on duty will prepare their PPE and will go to Pula airport using appropriate transport means.

The off-duty NAMIRG operators who are available to assist will go to their respective command units to prepare themselves, pick-up the necessary PPE and then wait for instructions on the planned boarding point, which they will go to as soon as possible, with appropriate transport means.

In addition to the PPE, the operators of the Trieste Command Unit, will be required to bring with them Puma radios, ATEX marine VHF radios and ATEX portable lamps, to be taken from the Nautical Detachment of Porto Vecchio.



The Pula operators, awaiting the arrival of the helicopter and other operators, will go to Pula airport and check the materials of the NAMIRG team to prepare them for boarding. If there is no NAMIRG operator in Pula, the first to arrive at the site will begin checking the material.

The NAMIRG official/officer on duty, if present, will take on the role of the NAMIRG Operations Commander (NAMIRG OC), should he/she not be present, this role will be taken on by the Team Leader who has the highest rank. If no Team Leader is present, the role will be taken on by the highest ranking Firefighter.

The NAMIRG Team Leader who has the highest rank, if present, will take on the role of NAMIRG Group Leader (NAMIRG GL); however, should he/she not be present, this role will be taken on by the highest ranking Firefighter.

The NAMIRG team and related equipment will be weighed and this data will be communicated to the helicopter crew for an evaluation of the operational autonomy.

The NAMIRG OC and GL will gather as much information as possible about the incident until it is time to board the helicopter and, based on this information, will carry out the first risk assessment of the mission and planning of the intervention.

Once at the target, they will visually check the actual conditions of the DV, flying over it, making a second risk assessment of the incident, which will either confirm the previous one or not, and decide whether or not to proceed with the intervention.

Once the team has landed on the DV it will carry out the third risk assessment together with the ship's master and will continue to constantly monitor its status, so as to have the situation under control at all times, keeping the SMC informed.

It is necessary to remind the ship's master of the presence of the NAMIRG team on board so that he can take it into account in the event of abandoning the ship.

The NAMIRG team must always be ready to abort the mission and leave the ship, where the operating conditions would not enable the team to work safely.

The MRCC/MRSC must always ensure that there is a means to allow the emergency evacuation of the NAMIRG team at the site of the incident.

The flow of information will take place primarily between the NAMIRG OC and the SMC, or possibly through the OSC (On Scene Coordinator), if present.

The MRCC/MRSC will communicate with the Fire and Rescue Service control room of his/her country, via the FLO, if any, and this control room will keep in touch with the fire and rescue services of the other countries.



Given the operational internationality of the NAMIRG team, all operators must always carry a valid ID document for expatriation.

To get an assessment of the status of the ship as consistent and unanimous as possible, an unambiguous assessment method should be considered, so that each operator involved in the rescue can get an accurate idea of the real extent of the intervention to be addressed, thereby modulating the response and optimising the use of available resources.

A method to carry out this assessment, which has already been codified and tested, is the Vessel TRIAGE. This method originates from an international project with a broad participation of the main sea rescue bodies in Finland, already proposed to the IMO for global use and currently used within the BSMIRG Project.

Given the number of actors involved in the activation of the NAMIRG team it could be useful to use a single form of data collection so as to locate the information in known areas, thereby simplifying and speeding up the alerting operations.

In this case, too, for uniformity of the documentation at a European level, the form envisaged by the BSMIRG Project could be taken into consideration:

MIRG Tasking Form

In incidents where foreign firefighters need to be alerted to assist with the response, the MRCC/MRSC could use the MIRG Tasking Form as a tool. The Tasking Form is intended to serve as a checklist for the MRCC/MRSC, guiding the collection of information that is significant for MIRG operations. The use of the MIRG Tasking Form ensures that the FRS representatives and MIRG teams are provided with information that is as comprehensive as possible, enabling them to assess the preconditions for MIRG operations and the related risks.

NAMIRG SOP 2 - OCCUPATIONAL SAFETY DURING A NAMIRG OPERATION

PURPOSE

This SOP defines the division of responsibilities with respect to occupational safety during a NAMIRG operation and the most critical issues that must be ensured during the operation and which should be monitored constantly in order to maintain occupational safety at a sufficient level. In addition, this SOP describes how to halt the operation and evacuate the MIRG team, from the DV (distress vessel) in the event of a sudden emergency.

RESPONSIBILITY AREAS AND TASKS

In accordance with international practice, SAR operations are coordinated by the SMC (Search and Rescue Mission Coordinator, the officer of MRCC/MRSC) of the SRR (Search and Rescue Region) in which the incident occurs. The SMC is responsible for general occupational safety during the operation; that is, he or she makes decisions about whether or not to transport rescue personnel to the scene of the incident.



On the DV, the NAMIRG OC (Operations Commander) has overall responsibility for assessing the risks involved in carrying out the operations. However, each NAMIRG GL (Group Leader) holds primary responsibility for the occupational safety of NAMIRG personnel. That is, once the operations have begun, the occupational safety of personnel on location is always the responsibility of the closest supervisor in their own organisation. The same applies to all working teams on the distress vessel. For instance, if members of the distress vessel's crew are to carry out rescue work, the Ship's Master of the vessel is responsible for their occupational safety.

PREVENTION TACTICS AND OCCUPATIONAL SAFETY

NAMIRG operations emphasise the importance of ensuring safety in one's own activities. In every incident, the greater the potential benefit of fire and rescue actions, the greater the risk that is accepted by commanders and firefighters. Activities that present a high risk to safety are limited to those that have the potential to save life or to prevent rapid and significant escalation of the incident.

NAMIRG operational tactics are often defensive, seeking to contain the fire in order to gain time for saving people, to avoid abandon ship and to allow its arrival to a port refuge, unlike the offensive tactics generally employed on land. However, when circumstances are favourable, offensive tactics may also be employed:

1. Defensive - This mode may apply to a sector and/or the entire incident. The NAMIRG teams tackling the operations do not work within or are not exposed to the hazard area. The identified risks outweigh the potential benefits; no matter how many additional control measures are put into place, the risks are too great.
2. Offensive - This mode may apply to a sector and/or the entire incident. The NAMIRG teams tackling the operations work within or are exposed to the hazard area. The level of risk to crews is justifiable in terms of risk and potential benefits.

KEY ACTIONS TO ENSURE OCCUPATIONAL SAFETY DURING A NAMIRG MISSION

- The final decision on whether to board the distress vessel is made by the MIRC OC after the location has been reconnoitred. In all situations, both when transferring and working on board, the ability to independently ensure safety during operations must be continuously taken into consideration.
- MIRC Group Leaders must remain constantly aware of where their team members are and keep a log of their whereabouts.
- The MRCC/MRSC must remain constantly aware of how many people have been sent to the distress vessel to participate in rescue operations.
- When a decision is made to dispatch a NAMIRG team to the location, it must always be ensured that the team can be evacuated.
- The primary means of evacuation is a helicopter, the secondary a surface vessel in the incident area. It must be taken into consideration that on the open sea it is often very difficult or even impossible to transfer to another surface vessel or smaller support boat. An extreme emergency measure is to abandon the vessel by descending a rope into the sea.



SITUATIONS PREVENTING NAMIRG ACTION

MIRG teams are generally not dispatched to locations where the operating conditions would not enable them to work efficiently and safely.

In a ship fire incident, this could mean, for instance:

- The wind direction is variable. A whirling wind or lack of wind may cause a situation in which there is no “clean-air area” on the distress vessel. In such cases, it is not possible to work on the vessel, as this would require the continuous use of breathing apparatus, which is not possible in practice.
- The fire systems of the vessel might not be functional. In such cases, either the firefighting water piping on the distress vessel has to be pressurised using the systems of another ship or firefighting operations have to rely entirely on the fire hydrant system of the other ship.
- The distress vessel has listed significantly or the water used for firefighting causes further listing.
- The seas are too rough for smoke diving and moving about on the distress vessel.
- The situation on board the distress vessel is so unstable that it is apparent that the incident may escalate in an unpredictable and uncontrollable manner, such as due to materials/chemicals carried as cargo on the vessel.
- If there are indications that the incident could have been caused by an act of terrorism, it is not safe to work on board the vessel until the situation has been assessed (bomb +1 principle).

CONCLUDING THE MISSION, HALTING OPERATIONS AND ABANDONING THE VESSEL

Once the mission has been concluded in a controlled manner or if it must be halted without the need to abandon the vessel, the NAMIRG team is evacuated with the most suitable surface or air unit, as indicated by the MRCC/MRSC.

The decision to leave the distress vessel is made jointly by the MRCC/MRSC, master of the vessel and the NAMIRG OC (Operations Commander).

In addition, if the safety of the NAMIRG teams on board the vessel is jeopardised, or if there are other justified grounds for doing so, the operations of the NAMIRG team can be halted by a decision of the MRCC/MRSC or NAMIRG OC. The master of the vessel must always be notified of the decision to halt the mission and abandon the vessel.

If the mission must be aborted because the vessel is abandoned, the NAMIRG team primarily exits the vessel using the ship’s own rescue equipment or the unit indicated by the MRCC/MRSC. In addition to the primary alternatives, the NAMIRG team must be prepared to abandon ship using its own equipment (such as ropes) to descend into the sea. The master of the vessel should always be prepared for the eventuality that the NAMIRG team will use the equipment of the vessel to abandon it. For this reason, when the NAMIRG team has come on board the distress vessel, the master of the vessel must always also take the NAMIRG team into account in preparations for abandoning the



vessel and indicate which muster station and equipment the team should use in such an eventuality.

NAMIRG SOP 3 - NAMIRG FIRE LIAISON OFFICER (FLO)

PURPOSE

The purpose of this SOP is to describe the key tasks and responsibilities of the Fire Liaison Officer (FLO) during the different phases of an operation.

ROLE OF THE FIRE LIAISON OFFICER

A Fire and Rescue Services (FRS) expert acts as a Fire Liaison Officer (FLO) at the Maritime Rescue Coordination Centre (MRCC/MRSC) in the event of an accident where FRS expertise is needed. The Fire Liaison Officer works under and supports the Search and Rescue Mission Coordinator (SMC).

The task of the Fire Liaison Officer is to ensure efficient cooperation with the authorities by supporting the operation commanders in communication and command support functions. These support functions may involve, for instance, ensuring the continuity of operations, assessing the availability of additional resources, organising logistics, etc.

The Fire Liaison Officer can also be called to the MRCC/MRSC simply to assess the situation as a consultant without alerting or using NAMIRG team or other rescue units.

DUTIES OF THE FIRE LIAISON OFFICER

- If necessary, the FLO acts as a link to the NAMIRG Operation Commander (OC) and MRCC/MRSC.
- The FLO ensures that all parties involved in the operation are kept fully informed of the NAMIRG team's actions.
- The FLO keeps the NAMIRG teams in the incident area fully informed.
- The FLO plans the continuity of NAMIRG operations in cooperation with the NAMIRG OC and SMC.

DEPLOYMENT OF THE FIRE LIAISON OFFICER

1. Actions in a mobilisation phase

After receiving the mission, the FLO must inform the other parties of his/her participation in the operation to the extent necessary (MRCC/MRSC, MIRC OC, FRSs) and transfers to the MRCC/MRSC as soon as possible.

2. Actions on arrival at the MRCC/MRSC

After having reported in to the SMC at the MRCC/MRSC, the FLO goes to his/her assigned workstation to test the functionality of the available equipment. If there are any defects, then replacements must be requested as soon as possible.



Once the FLO has received updated situational information, he/she reports the checked and supplemented information on the incident as well as information on the rescue organisation (e.g. key personnel and their contact information and the agreed communications arrangements) to those participating in the operations to the extent necessary (NAMIRG teams, FRS contact persons, etc.).

After updating the information on the incident and rescue organisation, the FLO checks and supplements the contact information for the NAMIRG teams participating in the operation and the number and operational capabilities of personnel, and confirms the transport units at the disposal of the NAMIRG teams, their transport capacities, agreed/possible boarding points and schedules. At this time, it must also be determined which actions have already been agreed, and the situational/status information on the resources alerted to the operation must be verified (on scene, on route, mission received but not yet on route, etc.).

3. Ongoing actions

The FLO continues to update and supplement information on the incident at the same time as he/she maintains situational awareness of the NAMIRG operation. The FLO plays a key role in ensuring that the SMC and NAMIRG OC have the correct and up-to-date situational information on the incident, the resources that are in use and any additional resources that might be required. The FLO must also see to it that all parties involved in the operation are kept fully informed of the NAMIRG team actions.

NAMIRG SOP 4 - NAMIRG OPERATIONS COMMANDER (NAMIRG OC)

PURPOSE

The purpose of this SOP is to describe the key tasks and responsibilities of a NAMIRG Operation Commander (NAMIRG OC) during the different phases of an operation.

ROLE OF THE NAMIRG OPERATION COMMANDER

The NAMIRG Operation Commander leads NAMIRG teams (and other FRS teams) in rescue operations on the distress vessel.

The NAMIRG OC works under the Search and Rescue Mission Coordinator (SMC).

The NAMIRG OC should liaise with the master of the vessel, carry out risk assessments, establish a Command Point, provide a tactical plan inclusive of further resource requirements and communicate regular situation reports to the Maritime Rescue Coordination Centre (MRCC/MRSC) and other authorities, if needed.

The NAMIRG Operational Commander's primary focus should be to prevent the need for evacuation of vessel and save lives. Rescuing property and preventing any threats of environmental damage is a secondary task.

DUTIES OF THE NAMIRG OPERATIONS COMMANDER



- The NAMIRG OC acts as a consultant and support in fire and rescue incidents to the master of the distress vessel.
- The NAMIRG OC makes the tactical and operational decisions required to stabilise and contain the incident on board the distress vessel in cooperation with the master of the vessel.
- The NAMIRG OC is responsible for occupational safety during the mission.
- The NAMIRG OC ensures that the MRCC/MRSC and master of the distress vessel are kept fully informed of the NAMIRG teams' actions.

DEPLOYMENT OF THE NAMIRG OPERATIONS COMMANDER

1. Actions in a mobilisation phase

After receiving the mission, the NAMIRG OC must inform the other parties of his/her participation in the operation to the extent necessary (FLO, MRCC/MRSC, FRSs).

The NAMIRG OC contacts the MRCC/MRSC and together with the SMC/FLO (if present) review the preliminary information on the incident and the distress vessel.

In addition, the NAMIRG OC informs the MRCC/MRSC of the contact information of his/her NAMIRG team, the number of personnel and their operational capabilities with respect to the mission.

The NAMIRG OC and MRCC/MRSC agree on the transport unit, the boarding point and schedule.

The NAMIRG OC and MRCC/MRSC together review the NAMIRG resources alerted to the operation and assess their adequacy and any additional resource requirements with a focus on achieving results.

2. Actions on arrival at the distress vessel

Upon his/her arrival at the distress vessel, the NAMIRG OC designates the boarding point and reports it to the MRCC/MRSC. The MRCC/MRSC records this information and forwards it to the other NAMIRG teams.

Then he establishes an evacuation/rest/fire station point with no exposure to danger, clear exits from the vessel and usually close to a winching point and in a protected area of the top deck

After that, the NAMIRG OC contacts the master of the distress vessel to verify whether the vessel still requires external assistance.

The NAMIRG OC and master together update the situational information on the vessel, incident and rescue organisation. The aim is to enable the NAMIRG OC to establish a more detailed view of the incident status, the risks involved, the actions the crew of the vessel has taken to deal with the incident and the effectiveness of these actions.

The NAMIRG OC also informs the master of the distress vessel about the number of NAMIRG teams arriving, their operational capabilities and any support measures required (guidance, communications devices, etc.). After updating the situational information, the NAMIRG OC makes the required tactical and operational decisions on



stabilising the incident together with the master and agree on where and how to set up the NAMIRG operation on-scene command point.

After these actions, the NAMIRG OC informs the MRCC/MRSC of the situation on board, the tactical and operational decisions, and the location of the NAMIRG operation on-scene command point.

If there is enough personnel on board the DV, in addition to the NAMIRG OC, at the NAMIRG command point there would be a NAMIRG officer, who serves as Command Support, and a suitable number of sector commanders. The primary duty of Command Support is to assist the NAMIRG Operation Commander in communications and maintaining the situation log. Sector commanders focus on coordinating the sectors designated by the NAMIRG Operation Commander. Coordination includes commanding and controlling the allocated resources, the tactical planning of operations in the sector and drafting a risk assessment

3. Ongoing actions

In addition to taking the required tactical and operational decisions, the NAMIRG OC ensures, with respect to NAMIRG operations, that occupational safety is maximised, operational continuity is safeguarded and information is disseminated. The NAMIRG OC ensures that the safety status of the vessel is monitored continuously and that occupational safety is upheld in all phases of the operation. In addition, the NAMIRG OC assesses the adequacy of the available resources and informs the MRCC/MRSC of any additional resource requirements with a focus on achieving results and safeguarding the continuity of NAMIRG operations. The NAMIRG OC is also responsible for ensuring that all cooperating parties are aware of the NAMIRG operations and their impact. It is especially important to ensure that the master of the vessel, the MRCC/MRSC and the NAMIRG teams on board are informed of the tactical and operational guidelines of the NAMIRG operations, etc.

4. Completion of operation

The NAMIRG OC participates in taking the decision to complete NAMIRG operations. The decision to conclude NAMIRG operations is primarily made jointly by the master of the vessel, the NAMIRG OC and the SMC (or other authority in command). The decision may also be taken by a single party (master of the vessel, NAMIRG OC or SMC) if there is a weighty and justified reason to do so. However, in such cases, all parties involved must be informed about the completion of operations and the reasons for this.

When the decision on the completion of the MIRG operation is made, the NAMIRG OC provides a situation report to the master of the vessel and the SMC concerning the measures that have been performed, the results achieved, any damage, and recommendations on further actions. In addition, together with the SMC, the NAMIRG



OC ensures that the decision to conclude NAMIRG operations and the reasons for this are recorded and entered in the MRCC/MRSC situation log.

NAMIRG SOP 5 - NAMIRG GROUP LEADER (NAMIRG GL)

PURPOSE

The purpose of this SOP is to describe the key tasks and responsibilities of a NAMIRG Group Leader (NAMIRG GL) during the different phases of an operation.

ROLE OF THE NAMIRG GROUP LEADER

The NAMIRG Group Leader leads operations at a technical level, and is responsible for smoke diving safety.

The NAMIRG GL works directly under the NAMIRG OC. The NAMIRG GL key task is to ensure the team's occupational safety. His/her primary focus should be to prevent the need for evacuation of vessel and save lives. Rescuing property and preventing any threats of environmental damage is a secondary task.

DEPLOYMENT OF THE NAMIRG GROUP LEADER

1. Actions in a mobilisation phase

After receiving the mission, the NAMIRG GL contacts the NAMIRG OPERATION COMMANDER and together review the preliminary information on the incident and the distress vessel

2. Actions on arrival at the distress vessel

Upon his/her arrival at the distress vessel, the NAMIRG GL determines the operational situation and the measures that the vessel's crew have been carried out, then the communication system to be used to communicate with the NAMIRG OC at the command point (FRS radios, direct channel, vessel's own communication devices)

The NAMIRG GL receives the NAMIRG team task from the NAMIRG OC and then he asks a Fire/Safety Plan to determine any resources the vessel can offer and to plan the team task together with the crew officer coordinating firefighting operations

3. Ongoing actions

During the operations, the NAMIRG GL ensures that occupational safety is maximised
The NAMIRG GL monitors smoke diving, conducts a risk assessment of any rescue dives and evaluate the sufficiency of resources, air bottles, reserve personnel and food and drink.

4. Completion of operation

When the NAMIRG OC communicates the decision to complete NAMIRG operations the NAMIRG GL ensure that everyone leaves the distress vessel safely.



NAMIRG SOP 6 - NAMIRG CREW MEMBER (FIREFIGHTER)

PURPOSE

The purpose of this SOP is to describe the key tasks and responsibilities of a NAMIRG Crew Member during the different phases of an operation.

ROLE OF THE NAMIRG CREW MEMBER

The NAMIRG Crew Member works under the NAMIRG Group Leader and he/she is a member of the NAMIRG team.

The NAMIRG Crew Member performs all tasks given by the NAMIRG GL. Actively reports on the progress of the mission, and immediately reports on any changes in risks or other factors.

DEPLOYMENT OF THE NAMIRG CREW MEMBER

1. Actions in a mobilisation phase

After receiving the mission, the NAMIRG Crew Member obtains preliminary information about the situation from the NAMIRG OC/GL, and then he prepares personal basic equipment in accordance with the separate checklist for helicopter boarding.

The firefighter undertakes personal care before entering the helicopter

2. Actions on arrival at the distress vessel

The Crew Member takes note of the conditions on the vessel's deck, conducts a controlled transfer of equipment and, if necessary, mooring it to the landing site.

Establishes an evacuation/rest/fire station point in a place where both crew and equipment is protected, following NAMIRG GL instructions.

3. Ongoing actions

The firefighter obeys the NAMIRG GL's instructions in order to perform the mission safely and effectively

4. Completion of operation

The firefighter returns to the vessel's crew all the equipment and tools provided by the vessel (e.g. radios, Fire/Safety Plans, etc.)

NAMIRG SOP 7 - COMMUNICATION

PURPOSE

The purpose of this SOP is to help all those participating in rescue operations to understand the general principles of communications. Organising effective communications between the MRCC/MRSC, distress vessel (DV) and rescue units is an integral part of rescue operations, and is the responsibility of the SAR authority coordinating the situation.



RESPONSIBILITY AREAS AND TASKS

MRCC/MRSC drafts a communications diagram for the incident in question and states which communications channels are to be used.

In communications during a NAMIRG operation, it must be ensured that all rescue operation-related communications from the incident area go through the coordinating MRCC/MRSC before being relayed to other actors. The rescue units must not bypass the MRCC/MRSC when reporting on their operations; otherwise, the MRCC/MRSC's coordination-related situational awareness and decision-making may be based on incomplete information. Other authorities may turn to the MRCC/MRSC for information about the current situation or they might station a representative of their own at the MRCC/MRSC to maintain contact with their organisation.

The exception to this is the distress vessel communications with its own shipping company, commercial tugs, interest organisations (e.g. insurance company) or experts. If these communications shed light on information that has a bearing on the rescue operation or people's safety, the master of the vessel is obligated to inform the MRCC/MRSC about them.

COMMUNICATIONS TOOLS

During the alert phase, communications will be made using the most appropriate means available, via e-mail, telephone, radio, etc.

The receipt of communications via e-mail must always be confirmed.

The vessel's primary means of communications is Maritime VHF. In addition, contact with the vessel can be maintained with MF-HF radio, satellite phone, GSM or Inmarsat C. In long-distance communications, such as when outside the range of VHF, it may be necessary to use MF-HF frequencies or air/surface craft to relay communications. The main communications tools used by the MRCC/MRSC and rescue units are Maritime VHF radios, GSM, satellite phones and other technical devices that are suitable for transmitting situation reports and electronic messages (email, certain surveillance devices, fax, etc.).

If the distress vessel is located far away, the external help/NAMIRG Operation Commander, may have to rely on the vessel's communications equipment to maintain contact with land. In such cases, communications from the vessel are carried out under the supervision and with the support of the vessel's own crew.

Communications between the NAMIRG team and the helicopter will be maintained with marine VHF radios.

NAMIRG teams/external rescue units on board the vessel (principally) use their own communications devices (VHF, UHF).



If communications on board the distress vessel are prevented for structural or other reasons, the crew should reserve communications equipment for the NAMIRG teams insofar as this is possible.

Even though the NAMIRG OC (Operations Commander) also communicates situation updates from the vessel to the MRCC/MRSC to the extent necessary, the master of the distress vessel has the actual responsibility for communicating information from the distress vessel to the MRCC/MRSC.

NAMIRG SOP 8 - OPERATION WITH HELICOPTER

PURPOSE

The purpose of this SOP is to give to the NAMIRG team the procedures for helicopter transport. This SOP is necessary for safe and controlled operations, in line with flight regulations, and also to control emergency situations.

RESPONSIBILITY AREAS AND TASKS

The pilot of the helicopter leads all operations.

All those participating in maritime search and rescue tasks must wear a rescue suit throughout the helicopter flight.

Any equipment must be packed in the appropriate lockers.

The helicopter's crew is responsible for packing the helicopter's equipment.

The NAMIRG OC or GL should be aware of the total weight of the team and its equipment. All gear, persons, and personal equipment must be weighed before take-off, and the pilot of the aircraft must be notified of the combined weight to an accuracy of 5 kg, preferably as soon as the information is available, but at the latest on arrival at the aircraft. A helicopter's load capacity varies according to weather conditions and the planned route. The helicopter's crew determine where rescue personnel will sit in the helicopter; rescue personnel maintains seatbelts fastened at all times.

The NAMIRG OC asks to the helicopter's crew whether headsets are available for listening to radio traffic.

NAMIRG Team operators must obey all orders given by the helicopter crew.

The crew of the distress vessel must perform certain actions before helicopter can approach it for starting winching operations.

NAMIRG SOP 9 - OPERATION FROM A VESSEL

PURPOSE

The purpose of this SOP is to give to the NAMIRG team the procedures for a safe transfer to the DV from a vessel, which can be used to travel to the scene of an accident if there are special grounds for doing so.

RESPONSIBILITY AREAS AND TASKS



Transferring to the DV using a vessel may be extremely slow, difficult and dangerous. When the options have been identified, the total time required for the transfer must first be estimated, and thereby the appropriateness and viability of the operation. The master of the vessel is responsible for both the transfer and the safety of the operation, and he will decide on whether any personnel will be transferred to the target. There is the necessity to consider the safety of the NAMIRG team when operating out of a boat, and that in certain conditions the ship-to-ship transfer could be impossible. Transfer to the DV mainly occurs through the pilot hatch/boarding station. Equipment should primarily be transferred to the vessel using cranes and other aids, in small and light units. If the vessel is to be boarded using a pilot ladder, the first NAMIRG person across should climb the ladder and arrange a safety rope to secure all other members of the team, that should always attach their harnesses to the safety rope as they climb up to the deck.

NAMIRG SOP 10 - VESSEL FIRE

PURPOSE

The purpose of this SOP is to support decision making and managing firefighting efforts on board a vessel.

NAMIRG Team supports the vessel's crew in its firefighting operations and the primary focus should be to prevent the need for evacuation of vessel and save lives. Rescuing property and preventing any threats of environmental damage is a secondary task.

8 Incident Command System for 'AT SEA' incidents (ICS)

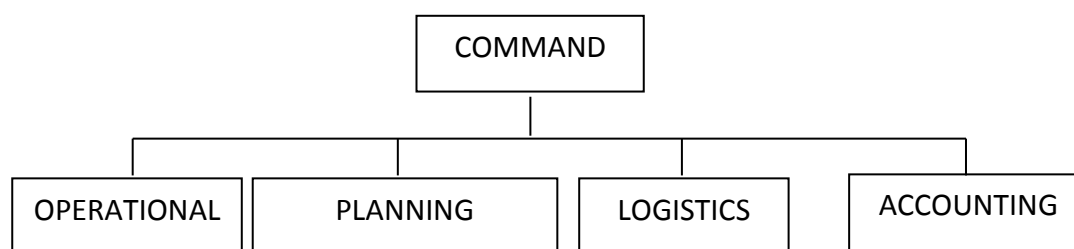

COMMAND Function

The Incident Commander is the competent Maritime Authority for the waters where the distress vessel is located.

For Italy it may be the MRSC Trieste, Venice or Ravenna depending on the position of the unsafe ship, or, in particularly serious cases, it could also be the MRCC Rome; for Slovenia it is the MRCC Koper; for Croatia it is the MRSC Pula, or similarly for Italy, in case of particularly serious accidents, MRCC Rijeka.



It is tasked with the general coordination of ship rescue operations and coordination of all the naval and air structures involved in the rescue operations. A representative of the Fire & Rescue Service (NAMIRG FLO - Fire Liaison Officer) is located at the facility to liaise with the MRSC/MRCC, the NAMIRG team and the ground Fire & Rescue Service units, in particular with the Fire & Rescue Service structures that directly support operations at sea.

The Command is taken on by the Maritime Authority Commander or his deputy. Depending on the availability of naval and personnel structures, the Command can also be attributed to a naval unit present in the area of operations (OSC On Scene Coordinator).

Tasks of the Command function are to:

- define the operational targets
- develop and implement the incident action plan
- define an appropriate organizational structure
- maintain control of the organization
- manage communications

OPERATIONAL Function

The person in charge of the operational function is the Fire Liaison Officer who directs the NAMIRG team that operates on board the distress vessel (NAMIRG OC - Operations Commander)

The FLO is responsible for the NAMIRG team that operates on board the distress vessel.

He/she is responsible for the safety of the team and consequently evaluates and decides on the boarding/transhipment of the team on the distress vessel, immediately contacting the ship's Master, the Chief Officer and the Chief Engineer to assess the situation and the tactics to be adopted (defensive - offensive). The operational priority is safeguarding human life.

As far as possible, the FLO establishes and maintains radio-telephone contact with the Command - IC so as to inform the Command - IC on the development of the situation, receive instructions and communicate any requirements.

Any additional resources and/or support needed to implement the actions on board the ship are requested by the FLO.

The Officer, in coordination with the ship's Master, communicates a possible evacuation of the NAMIRG team and the crew of the ship if the conditions thereof jeopardise the continuation of the rescue operations in safety.

PLANNING function

Given the incidental scenario, the planning function must be divided into two levels:

- strategic



- tactic

strategic planning is carried out by the Command - IC function and, essentially, includes management of the ship, where to bring it and how, considering the weather situation in the area. It must also provide at least one alternative solution for crisis management.

Tactical planning is carried out on board the damaged vessel by the operational function manager (NAMIRG OC). Tactical planning must ensure short-term answers regarding the control-management of the emergency in progress and the safety/rescue of human life. This planning must be carried out in coordination with the ship's Master.

LOGISTICS function

The task of the logistics function is to support the team operating on board the distress vessel in terms of human resources and materials.

The logistic function is at the head of the competent ground Fire & Rescue services on the territory washed by the waters where the distress vessel is located.

The logistics function also operates on two levels; the first is represented by the support vessel arriving on the spot with a possible second NAMIRG team and any technical material.

The second level is represented by the Fire & Rescue Service ground-based structure which receives the additional NAMIRG teams on arrival and organizes and prepares everything that is necessary for the uninterrupted continuation of operations on board the distress vessel. The logistics function interfaces with the Command via the FLO to organize deployment of what is necessary through the support vessel or other unit made available by the Command function.

ACCOUNTING-ADMINISTRATIVE function

It is a function of the ground-based Fire & Rescue Service structure of rescue operations. The accounting department takes into account any expenses incurred to support the rescue operations and, essentially, takes into account the fire personnel employed in the operations, recording the arrivals, departures and activities carried out in the context of the intervention.

The report of the activities carried out for each operator of the NAMIRG team will then be transmitted to the unit to which they belong for subsequent management.

9 Hazardous Materials

HAZARDOUS MATERIALS

The rules governing the transport of dangerous goods lay down provisions concerning:

- By sea – IMDG Code



- technical characteristics of the ship
- ship certification
- admissibility of the goods to be transported
- transport conditions
- By road - **ADR**
 - technical characteristics of the vehicle
 - vehicle documents
 - admissibility of the goods to be transported
 - transport conditions

Similar provisions are envisaged for rail transport (RID)

The rules concerning the **admissibility of goods for transport** and the conditions of transport are considerably similar as regards the various standards, therefore facilitating **intermodal transport** of hazardous goods.

CERTIFICATIONS

The Certificates required are.

- DOCUMENT of COMPLIANCE (*DOC*) or
- STATEMENT OF SUITABILITY

in relation to:

- date of construction
- type of ship (passenger or cargo)
- gross tonnage

SOLAS foresees only the **Document of compliance**.

In Italy, according to the law of the Italian Republic, **Italian or foreign** ships without a DOC must have a **Statement of suitability**.

The **Document of Compliance** (reg.54.3 SII-2) is prescribed for ships subject to SOLAS:

- All Passenger ships and cargo ships equal to or greater than 500 GT, built on or after 01.09.1984
- Cargo ships of less than 500 GT built on or after 01.02.1992

The **Statement of suitability** is required for:



- Foreign ships arriving at Italian ports
- Italian ships

That are:

➤ **subject to SOLAS**

- All Passenger ships and cargo ships equal to or greater than 500 GT built before 01.09.1984
- Cargo ships of less than 500 GT built before 01.02.1992

➤ **NOT subject to SOLAS**

- Cargo ships of any size in national shipping
- Less than 500 GT cargo ships built before 01.09.1984 in international navigation
- • Type C and D passenger ships of the Community flag built before 01.07.1998

As an alternative to the certification of suitability, the ships may have - if they meet the prescribed requirements - the Document of Compliance.

The statement of suitability is valid for max. 5 years with the obligation of annual audits.

N.B. The new legislation no longer allows the possibility of the "occasional trip"

THE SHIP

Regulation 54, Chap.II-2 establishes the requirements to be fulfilled by the **types of ships** and **cargo spaces** intended for transportation of hazardous goods in packaged form, unless they are transported in a "limited quantity".

The requirements concern:

- Availability of water to supply the fire collector and the cooling system
- Ignition sources originating from machinery, equipment and electrical cables
- Fire detection system
- Ventilation
- Bilge installations
- Mobile fire-fighting devices
- Insulation of the boundaries of the machinery spaces
- Pressurized water spray system



Tables 54.1 and 54.3 make it possible to verify which requirements are applicable to the various types of ship and cargo spaces taking into account the different classes of dangerous goods

- The IMDG Code rules do NOT apply to ship's provisions and equipment.
- Compliance with the IMDG Code standards ensures the **safety of people and the protection of the environment**

GOODS CLASSIFICATION

Goods are classified by:

- shipper/consignor (that is, the person or organisation packaging the dangerous goods for transportation)
- the competent Authority (in Italy that would be the General Command of the Port Authorities)

according to the indications contained in the IMDG Code

HAZARDOUS GOODS

The goods are divided into **9 hazard classes**

1. Explosives
2. Gases
3. Flammable liquids
- 4.1 Flammable solids
- 4.2 Substances liable to spontaneous combustion
- 4.3 Substances, which, in contact with water, emit flammable gases
- 5.1 Oxidizing substances
- 5.2 Organic peroxides
- 6.1 Toxic substances
- 6.2 Infectious substances
- 7 Radioactive material
- 8 Corrosive substances



9 Miscellaneous dangerous substances and articles

Class 1 - EXPLOSIVES

Labels of class

1



** Place for division – to be left blank if explosive is the subsidiary risk.
* Place for compatibility group – to be left blank if explosive is the subsidiary risk

The IMDG Code defines **explosives** as a solid or liquid substance (or a mixture of substances) which is in itself capable by chemical reaction of producing **gas at such a temperature and pressure and at such a speed as to cause damage to the surroundings**

The IMDG Code divides explosives into

- 6 sub-classes, or hazard “divisions” (1.1, 1.2, 1.3, 1.4, 1.5, 1.6)
- Compatibility Groups [from A to L (excluding I), N and S]

Class 2 - GASES

Gases are divided into

- Compressed gas
- Liquefied gas
- Dissolved gas
- Liquefied refrigerated gas

Gases are normally transported under pressure varying from high pressure in the case of compressed gases to low pressure in the case of refrigerated gases

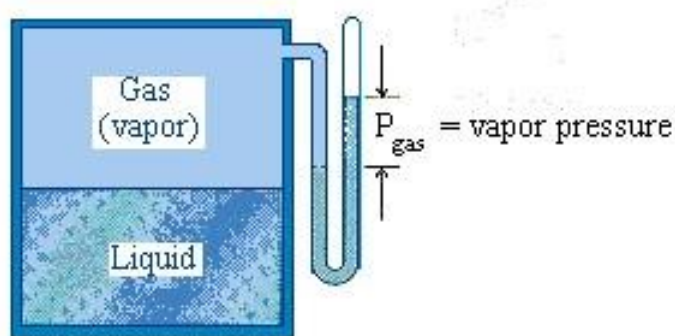

Vapour pressure or equilibrium vapour pressure is defined as the pressure exerted by a vapour in thermodynamic equilibrium with its condensed phases (solid or liquid) at a given temperature in a closed system. The higher the vapour pressure, the more dangerous the substance.

For sea transport, gases are divided further into three sub-classes that take into account their chemical characteristics and the physiological effects:

2.1 flammable (red label)

2.2 NON flammable and NON toxic (green label)

2.3 toxic gases (white label)



Class 3 – Flammable liquids

This includes liquids with a flashpoint at or below 61° C closed-cup test

Flammable liquids are grouped for packing purposes into three sub-classes according to their **flashpoint**, **boiling point** and **viscosity**



Packing Group	Flash point in C° Closed-cup	Boiling point in C°
I	–	≤ 35
II	< 23	> 35

III	$\geq 23 \text{ a } \leq 61$	> 35
-----	------------------------------	--------

Class 4.1 - FLAMMABLE SOLIDS



This class includes:

- solids which are readily combustible or may cause or contribute to fire through friction
- desensitized explosives
- self-reactive substances
- easily combustible solids
- solids that can contribute to fire

Some substances may evolve toxic and flammable gases when heated or if involved in a fire.

Class 4.2 - SUBSTANCE LIABLE TO SPONTANEOUS COMBUSTION



(No. 4.2)

Class 4.2

Substances liable to spontaneous combustion

Symbol (flame): black.

Background: upper half white,
lower half red.

Figure 4 in bottom corner.

This class comprises solids or liquids that are liable to spontaneous combustion caused by heat under normal transport conditions and by contact with air

These include:

- **Pyrophoric substances**, which are substances, including mixtures and solutions (liquid or solid), that even in small quantities, ignite within 5 minutes of coming into contact with air
- **Self-heating substances**, which are substances, other than pyrophoric substances, which, in contact with air without energy supply, are liable to self-heating. These substances will ignite only when in large amounts and after long periods of time (hours or days).

Some of these substances may also give off toxic gases if involved in a fire

Class 4.3 - SUBSTANCES WHICH, IN CONTACT WITH WATER, EMIT FLAMMABLE GASES



(No. 4.3)

Class 4.3

Substances which, in contact with water, emit flammable gases

Symbol (flame): black or white.

Background: blue.

Figure 4 in bottom corner.

This class includes organic and inorganic substances, organometallic compounds or compound solutions which, by **interaction with water**, may emit flammable gases that can form explosive mixtures with air.

Class 5.1 - OXIDISING SUBSTANCES



(No. 5.1)
Class 5.1

Oxidizing substances

Symbol (fl)

Figures 5.1 in bottom corner.

The class of **oxidizing substances** includes substances which, while in themselves are not necessarily combustible, may nevertheless by yielding oxygen or other gases, cause, or contribute to the violent and rapid propagation of a fire.

These substances may also give off toxic or corrosive gases if involved in a fire

Class 5.2 - ORGANIC PEROXIDES



(No. 5.2)
Class 5.2

Organic peroxides

Background: yellow.

Figures 5.2 in bottom corner.

After explosives, peroxides are by far the most dangerous goods.

Organic peroxides are substances that are liable to exothermic decomposition at normal or elevated temperatures. The decomposition can be initiated by:

- heat
- contact with impurities
- friction
- impact

The rate of decomposition increases with temperature and varies with the organic peroxide formulation. Some organic peroxides may decompose explosively.

Class 6.1 Toxic substances

Labels of class
6



This class includes substances that if

- swallowed
- inhaled or
- by skin contact

are liable to cause alterations, dysfunctions or serious injury to the **human body** or have a **lethal effect**, even in relatively small amounts, by instant or short-term action.

Many toxic substances are also **flammable** (*secondary risk*) or evolve toxic gases when involved in a fire or when heated to decomposition.

Many substances can only be transported if they are stabilized.

The substances may be in a **liquid** or **solid** state.

The **toxic hazard** during transport must be taken into account for the “packing group”.

Packing group I	HIGH TOXICITY RISK
Packing group II	MEDIUM TOXICITY RISK

Packing group III

LOW TOXICITY RISK

Class 6.2 INFECTIOUS SUBSTANCES

This class comprises:

- Substances containing vital micro-organisms (including bacteria), viruses (biological agents), parasites, fungi and other combinations of hybrid or mutant microorganisms which are known or are reasonably expected to cause disease in humans or animals
- Genetically modified micro-organisms and organisms
- Biological products
- Patient specimens
- Wastes derived from the medical treatment of animals or humans or from bioresearch

Class 7 - RADIOACTIVE MATERIALS

Labels of class

7



The following information shall be included:

- The name of the radionuclide (e.g. Thallium) or LSA-1, as applicable
- Maximum activity in Becquerel (Bq)
- Mass of fissile material in units of grams (or appropriate multiples thereof), may be used in place of activity (*only for fissile materials*)
- Transport index (excluding Category I - WHITE)

CSI must be shown

This class includes materials with a specific activity over **70 kBq/kg** as well as objects containing such materials

Radioactivity (A): the number of decays that occur in a given time of a radionuclide; given in **Becquerel** [Curie Ci was used up until 1975]

Specific activity: A is defined as radioactivity per unit mass "m" of the radionuclide; given in units of **Bq/g** [Ci/g was used up until 1975]

Class 8 - CORROSIVE SUBSTANCES

Labels of class

8



Corrosives substances are divided into three "packing groups" according to their degree of hazard in transport

Packing group I	Very dangerous substances and preparations
Packing group II	Substances and preparations presenting medium danger
Packing group III	Substances and preparations presenting minor danger

Comprises liquid or solid substances, which, by chemical action, will cause severe damage:

- in the case of leakage, to living tissue, metal or other materials, the means of transport (vessel) or other goods and injury to people
- when in contact with epithelial tissues of the skin, mucous membranes or the eyes, as well as to attack steel and aluminium

Corrosive substances may

- be sufficiently volatile to evolve vapour irritating to the nose and eyes;
- also give off toxic gases if involved in a fire
- be toxic or harmful.

Many corrosive substances must be transported in **stabilized** state

Some substances in this class only become corrosive after having reacted with water, or with moisture in the air. The reaction of water with many substances is accompanied by

the liberation of irritating and corrosive gases. Such gases usually become visible as fumes in the air.

Class 9 – MISCELLANEOUS DANGEROUS SUBSTANCES AND ARTICLES

Labels of class

9



This class includes substances and articles not covered by other classes which experience has shown, or may show, to be of a dangerous character.

Some products require additional marking
Substances that are transported

- in the **liquid** state at temperatures equal to or exceeding 100°C
- in the **solid** state with temperatures equal to or exceeding 240°C

shall be the mark shown in the figure

Mark for transport at elevated temperature



In addition, the maximum temperature of the substance expected to be reached during transport shall be durably marked

This label is required by ADR and RID standards (but not the IMDG CODE) for packages that must be transported upright.

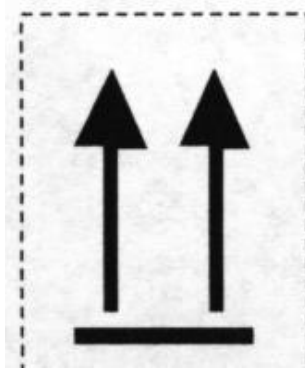

Many goods, have a secondary risk (*subsidiary risk*), besides the primary one.

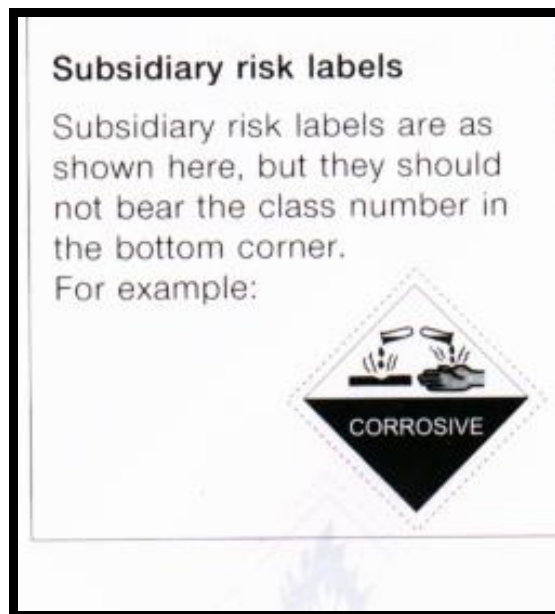

Many goods, besides being dangerous are also marine pollutants:

- **P** Marine pollutant
- **PP** Severe marine pollutant

Substances are classified as marine pollutants only if they contain 10% or more of substances identified with **P** or 1% or more of substances identified with **PP**.

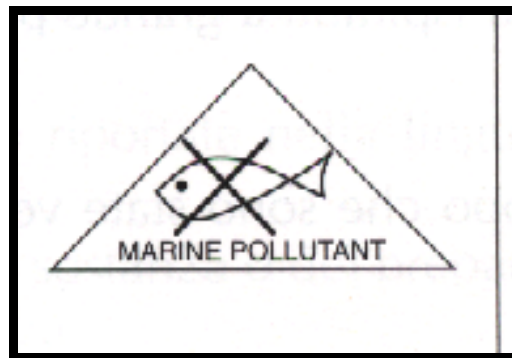

Related data is contained in the Dangerous Goods List of the IMDG Code

WASTES

Wastes that, due to their physical, chemical toxicological and ecotoxicological properties, are classified and certified by the producer as dangerous goods according to current law, are transported according to the following regulations:

- **IMDG Code** by sea
- **INF Code** by sea
- **ADR** by road
- **RID** by rail

INF Code - International Code for the safe carriage of packaged irradiated nuclear fuel, plutonium and high-level radioactive wastes on board ships

Notwithstanding the provisions contained in

- the Basel Convention on the control of transboundary Movements of Hazardous Wastes and their Disposal (1989)
- EU Directives (91/156/EEC, 91/689/EEC and 94/62/EC) [*partially to the Countries of the European Union*]
- national provisions

The PSN on shipping documents (Multimodal Dangerous Form, Bill of Lading etc..) shall be preceded by the word WASTE

Waste shall always travel with the documentation required by the regulations on waste transport

IMDG CODE

The new IMDG Code (Amdt. 30-00) in force since 01.01.2001

[*the former Code has not been in use since 01.01.2002*]



Lists in the **Dangerous Goods List**

- Dangerous goods commonly transported with the proper shipping name (PSN)
- Names of generic articles or substances not otherwise specified (N.O.S.)

Substances or articles which are not specifically listed by name in the Dangerous Goods List shall be classified under a "generic" or "not otherwise specified" (N.O.S.) Proper Shipping Name

The Dangerous Goods List is divided into 18 columns each containing information for each article, including:

- UN Number
- Proper shipping Name (PSN)
- Class or division
- Subsidiary risk (s) and Marine pollutant
- Packing group
- Packing instructions
- EmS n°
- Stowage and segregations

The Dangerous Goods List is accessed with a UN number. An alphabetical list of dangerous goods with related UN number can be found at the end of the IMDG Code.

C, B, R, N RISK - "E" RISK

CBRN stands for Chemical, Biological, Radiological and Nuclear.

Chemical risk - C - is due to the dispersion of a chemical substance that is harmful to humans (by inhalation, ingestion and/or contact with the skin) and/or the environment.

Biological risk - B - it is represented by the dispersion in the environment of an infectious or contagious pathogenic microorganism (such as bacteria, viruses, fungi, toxins, bioregulators), capable of causing serious or deadly diseases for living beings by penetrating the body by inhalation (in the form of aerosols), by cutaneous absorption or by ingestion of contaminated water or food.

Radiological risk - R - this risk is represented by an emission of ionising radiations into the environment by a sealed radioactive source (irradiation) or by a radioactive substance or dust (environmental contamination). Contamination may be *external* where there is exposure or contact with contaminated objects or surfaces or a deposit of radioactive dust on the skin; *internal* if dust is inhaled or contaminated material is ingested. In the latter case, any damage due to radioisotope toxicity is added. Hazardous material may consist of



radioactive waste stored in controlled depots, radionuclides in sealed packages used in medical or scientific laboratories for diagnostic or therapeutic uses, radioisotopes present in machinery or equipment used in the health and industrial fields, in fire detectors also installed in collective activities and radioactive material in transit on road or rail vehicles, airplanes, ships.

Nuclear risk - N - this risk is linked to the emission of energy and ionising radiation following a nuclear reaction (fission or nuclear fusion) of a substance. It is, however, normally referred to an accident at a nuclear power plant or a nuclear-powered vehicle or the use of a nuclear device.

Risk of explosion - E - this risk is due to the presence of an explosive substance or a cloud of dust or gas which could explode.

It is clear that the "E" risk belongs to a different type of CBNR risk since it does not involve environmental contamination in the real sense of the word.

Nevertheless, adding and associating the "E" risk with the CBNR risk derives from the following considerations:

- there is a strong similarity in the intervention approach that requires, first and foremost, a careful assessment of the safety distances in relation to the quantities of material involved and the structure of the places
- in many cases the ability to form a flammable cloud relates to substances that also present the risk of toxicity (risk C)
- in the non-conventional CBNR risk, an explosive charge is frequently used as a system to cause or accelerate the dispersion of a CBNR contaminating agent or to increase its effect, making egress and rescue more difficult.

The risk conditions, methods of protection, decontamination and treatment actions possible vary depending on the type of contaminating agent, quantity, concentration, individual sensitivity, health conditions and the environmental and weather conditions.

The effect on the human body by contact with the contaminating agent can be:

- certain or statistical (stochastic)
- immediate or remote (deferred)
- temporary (reversible) or permanent (irreversible)
- mild, severe or lethal

The possibilities of detecting and protecting vary according to the type of risk and the contaminating agent.

Indicatively, the characteristics of the CBRN risk (E) can be summarised in the following table



Summarising table of the CBRN(E) risk

Risk	Effect	Lethality	Rapidity of effect	Detection		Personal protection
				Sensory	Instrumental	
N	Usually stochastic, certain for very high doses	Can be very high for serious incidents	Usually deferred, immediate for very high doses	Impossible	Rather easy	Difficult for extended and persistent fall-out
B	Certain or stochastic depending on the agent and contact conditions	Can be very high	Not immediate	Impossible	Rather difficult	Possible in a limited area
C	Certain or stochastic, depending on the substance and dose	Can be very high	Immediate or deferred	Possible in certain cases (smell)	Possible	Possible for a limited time and with trained personnel
R	Usually stochastic	Not usually high	Not immediate	Impossible	Rather easy	Possible in the area and for a limited time, easier for α and β radiations
E	Certain	Can be very high	Immediate	Possible in some cases (smell)	Possible only for gas	Impossible in the area of impact

For the safety of the rescuer, the practicality of the intervention and its effectiveness the following are of paramount importance:

- perception of the risk
- identification of the type of risk
- identification of the contaminating agent
- measurement of the contaminating agent
- availability of adequate protections
- skill on the use of protections
- availability of adequate procedures and schedules

CONVENTIONAL AND UNCONVENTIONAL RISK

A CBRN risk is defined as **conventional** when contamination of the environment that can cause damage to public health or make places inaccessible/unusable is due to an *accident*, usually during the course of industrial/commercial or transport activities.

A risk associated with the event of *deliberate* dispersal of contaminating agents is defined as **unconventional**.

The agents produced and used for deliberate actions with the intention to involve a large number of people are called *unconventional agents* or *Weapons of Mass Destruction (WMD)*. In the chemical field such agents are usually called *Chemical War Agents (CWA)*

Considering recent and current international and internal developments, these events are more precisely referred to acts of terrorism, aimed at causing numerous civilian victims or striking specific targets, spreading uncertainty and fear among the population, which undermine the fundamental principles of democratic and civil coexistence.

Given the intention to affect as many people as possible, the unconventional risk is more likely in crowded areas or structures or in plants or depots that are able to spread substances that are intended for human use: these places take the name of *sensitive targets*

Due to the deliberate nature, the relevance of the effects and the objective of subversion of democratic institutions or normal relations of civil coexistence, the unconventional risk involves the *Civil Defence*, i.e. the National Department of Defence, which deals with the effects of such disruptions on the population.

On the other hand, an industrial, civil or road accident - i.e. a conventional risk - invests the State institutions and the local government bodies with the ordinary functions to safeguard the territory, as required by Law n°. 225/1992, which establishes the national civil protection service and regulations on major-accident hazards of certain industrial activities - the so-called "Seveso Law".

Similar classifications can be applied to events where explosions are expected due to the activation of explosive materials or triggering of clouds of flammable gases or vapours - "E" risk - whether they are connected to the dispersion of CBRN contaminating agents.

Features of unconventional biological risk

The agents used in a biological attack are intended to spread deadly, serious and disabling, irreversible diseases or whose therapy is currently impossible or difficult or require prolonged treatments.

These agents allow a latency period to spread the contamination by means of contact with the contaminating agent dispersed or placed in environments or in food or through transmission from one person to another, before the effects are manifested (*silent dissemination*).

They can be dispersed in the air in the form of aerosols or on a powdery substrate or used for contamination of the food chain.



There are body and respiratory protections in the event of a biological risk, but detection is still rather difficult. It is therefore very difficult to circumscribe the contaminated areas in all cases in which the biological agent is not confined in containers or closed spaces or is not in a spore state on solid support media.

In the event of the spread of contamination in the collective, domestic and health environments, limiting transmission quickly becomes ineffective and the organisation of social life is radically altered.

Features of unconventional chemical risk

Unconventional chemical agents are used in very small quantities to provoke high levels of lethality or incapacitation in very short times.

They are divided into groups

- nerve agents
- blistering agents
- blood agents
- choking agents
- incapacitating agents
- irritant agents
- herbicide agents

There are different types of detection and protection means, depending on the physical state and aggressiveness of the substances. Many substances also possess a characteristic odour.

Given the immediate effects, the detection possibilities and the progressive dilution in the atmosphere, it is easier to define areas of impact and safety, even with rapid methods.

Features of unconventional radiological risk

This risk consists in the diffusion of radioactive materials capable of causing effects on the organism. Contamination can essentially be of two types:

- *internal* contamination as a result of inhalation or ingestion of substances that emit *alpha*, *beta* or *gamma* radiation. Protection is relatively simple, whereas treatment is practically impossible. Furthermore, some radioactive isotopes, such as uranium and plutonium, have a high toxicity
- *external* contamination by *gamma*-type radiation sources

Hand-held instruments are available to detect and measure environmental radioactivity of the *alpha*, *beta* and *gamma* type. On the other hand, there is no possibility of sensory detection.

Protection from internal contamination is relatively simple through the use of breathing apparatus and light-weight clothing (the dermal layer is already a good barrier to the particles). Protection of body irradiation against *gamma* radiation, which would require screens of considerable thickness and weight, is rather difficult.



Damage is usually latent over time and distributed on a statistical basis.

Radiological attack is therefore used to disseminate panic and a sense of helplessness than to produce numerous victims in a very short time.

INDICATORS AND APPROACH TO A CBRN(E) RESPONSE

The common factor in as CBRN(E) risk is that of making the *environment* in which the rescuer is called to operate dangerous, unlike traditional events in which the operator can approach the scenario by taking ordinary protective measures (hand protection, safety glasses, flame-retardant equipment and safety footwear).

As we have seen, this risk can be determined by contact with harmful agents (chemical or biological substances and radiation) or by the possibility of being subjected to the emission of gamma rays or by the possibility of suffering *mechanical effects* (pressure waves and flying fragments) and *thermal effects* of an explosion (of explosives, gases or of inflammable powders and nuclear explosion).

Moreover, the presence of risk is not directly detectable by the senses (sight, smell, hearing, taste and touch).

It follows that:

- the safety of the operator and his/her own ability to operate depend in a fundamental way on the adoption of suitable *protection measures*, such as safety distances, personal protective equipment (PPE) and suitable planning of operations
- the ability to *perceive* a risk and carefully and correctly interpret the initial information available is of primary importance to be able to respond well and avoid the possibility that the rescuers themselves are victims of the event.

It is therefore essential to grasp and identify the elements, known as *indicators*, on the basis of which it is possible to presume the presence of a CBRN risk.

Only in certain cases can the CBRN emergency be *immediately evident*; for example when the report concerns

- ☑ spills or dispersions of powders, liquids, gases known as toxic or otherwise harmful
- ☑ illness, skin breakouts or other, reported by several people on the ship apparently without a precise or traumatic cause
- ☑ Unusual smells in the environment.

In other cases, the reported or ascertained event of a traditional nature (*fire, road accident, vandalism, etc.*) may involve *sensitive targets or environments, means of transport or containers* with dangerous substances or capable of causing dangerous emissions, for example:

- ☑ fire inside a plant that produces or uses toxic or that can issue toxic substances, laboratories, hospitals and ships
- ☑ explosion without obvious effects inside a crowded place



Considering that in 50% of cases deliberate acts (unconventional risk) apply the practice of "*duplication*" (a first event with the effect of luring and one or more subsequent with the effect of damaging), the operator must also pay adequate attention to events without damage, but such as to *lure* rescuers and people inside or near sensitive targets such as a passenger ship or an oil tanker.

When a CBRN(E) risk is established or there is a reasonable suspicion to that effect, the NAMIRG team is NOT deployed to the ship

If the NAMIRG team is on the ship, and if there is a reasonable suspicion of there being a CBRN(E) risk, all the procedures for the following must be put in place:

- ☑ operator *protection*
- ☑ definition and delimitation of *dangerous areas*
- ☑ *detection* or measurement of presence, concentration and intensity
- ☑ involvement of the *relevant bodies*, for their respective competence
- ☑ involvement of territorial *institutions* and government bodies, also in relation to the aspects of information management to the public

From all the above, it is clear that the CBRN(E) event needs to be tackled from the beginning with particular caution, applying the concepts of

- *risk assessment*
- *safety distance*
- *personal protection*
- *operational planning*

The difficulties in perceiving, detecting and measuring on the one hand, the severity of the possible consequences on the other, the urgency of the rescue operation and the uncertainty about the evolution of events certainly make an intervention in the event of a CBRN(E) risk very delicate.

For these reasons, the CBRN(E) emergency approach requires to put in place the highest level of professionalism of the operators putting the safety of the rescuer at the centre of the action as a requirement for the effectiveness of the rescue operation, therefore, the CBRN team should be alerted as soon as possible.

The CBRN ORGANIZATION OF THE NATIONAL FRS (Fire & Rescue Service):

The organizational model of the National FRS CBRN response provides different levels of intervention in relation to the required competence and the extent of the emergency:

- ➔ the first and most widespread intervention level is by the *basic team*, comparable to the NAMIRG team.



- basic teams are supported by *provincial experts*, present at each Provincial Command, who have more in-depth knowledge in the use of detection and measuring instruments and other equipment available
- when the intervention requires higher or different skills and equipment, the decisive intervention is entrusted to the *CBRN Regional Operational Unit* (ordinary or advanced) present in each region and operating, as a rule, in each Regional Command Headquarters
- to address specific situations, for example in the N/R sector, which require particular skills or abilities, individual figures or teams of *national experts* who, activated by the Operations Center (CON), provide the necessary support for decisions and operations
- just as with the ordinary model of mobilisation of the National FRS, which makes it possible for the means and personnel of several Commands and Regions to merge in a scenario, according to the needs, using the Mobile Convoy device, the CBRN sector also uses basic teams, provincial experts, regional units and CBRN national experts from several provinces and regions

The organizational model described is based on a graduated scale of individual expertise distinguished in *levels of competence*:

- *basic level* for the basic team, so-called *0-1 level* respectively for the firefighters (VIG) and the officer in charge, i.e. team leader or chief of department (CSQ, CR)
- *intermediate level (level 2)* for provincial experts (VIG, CSQ, CR) and Technical Officers
- *upper operational level (level 3 - "operational function")* for the operators of the Regional Operational Unit, the relative Operational Manager and Coordinating Officer
- *upper level of coordination (level 3 - "directive function")* for rescue officers who replace or support the provincial manager in the task of coordinating the rescue operations ("Incident Commander" - IC or "Technical Relief Coordinator" - DTS)

The difference in the competence is matched by a training plan that provides

- ✓ *basic training* for the staff of the basic team
 - ✗ with a training module inserted in the entry course (VIG) and qualification (CSQ)
 - ✗ with a *basic module* (of at least 8 hours) for the alignment of personnel already in service
- ✓ a *basic level 2 course* (at least one week, normally two weeks) for all other figures
- ✓ a *level 3 operational course* (of at least two weeks, currently 3 + 2 weeks) for operators of 3rd level "operational function"
- ✓ a *level 3 management course* (of at least a week) for officials who perform emergency services



The basic training plan is then integrated with updating activities, such as refresher or further training courses (for example in the field of N/R risks and environmental surveying)

GUIDELINES FOR THE CBRN RESPONSE

The "Guidelines for chemical, biological, nuclear and radiological response following a terrorist attack" have been drafted with particular reference to unconventional risk; however, most of the indications referring to:

- ✓ Operating Room functions
- ✓ actions to be performed upon arrival on site
- ✓ decontamination, where necessary
- ✓ subsequent operations

are transferable to traditional CBRN emergencies.

Therefore, reference is made to these indications, once again drawing attention to the need that traditional logic - "*go, assess and provide*" - is partly modified, emphasising and anticipating the identification, categorization, sizing phase, prediction of risks, protections, skills, technology needed to face and solve the emergency event: "*assess, identify and organize the forces, go, assess on the spot and provide*"

Particular attention must be paid to the correct positioning in a "cold zone" at a distance from the point of the event which, depending on the case, can be as follows:

- ✓ from 30 to 100 meters for small events and quantities involved ("backpack")
- ✓ from 100 to 300 meters for medium events and quantities ("small tank")
- ✓ 300 to 1,000 meters or more for major events and releases ("tankers")

CBRN RESCUE ORGANISATION

The *Prefect* is responsible for coordinating Civil Defence and Civil Protection interventions in the provincial area. In particular, he/she provides the initial information and updates the political and institutional summits.

On the basis of the information received from the Commander of the FRS (Technical Relief Coordinator - DTS), the Head of SUEM-118 (Medical Relief Coordinator - DSS) and the Police Commissioner on the extent and evolution of the event, the public is informed, the summits and/or the public information bodies are updated.

The *Provincial FRS Commander* - or his substitute - assures the Technical Relief Coordinator and coordinates the performance of the functions assigned to the National FRS as previously listed.

The *Police Commissioner* coordinates the Police Forces (PS, CC, GdF, CFS, PolStrada, VVUU) in the tasks of public order and safety and collaboration with the emergency relief



The *Coordinator* of SUEM-118 assures the Directorate of Medical Relief and coordinates, in particular:

- ✓ decontamination of victims
- ✓ medical treatment
- ✓ the supply of antidotes and drugs
- ✓ the setting up of field structures for shelter and care

The *Director of the Local Health Centre (A.S.L.) and of the Regional Environmental Protection Agency (A.R.P.A.)* guarantee, each for their respective competence and according to the case, controls on water and food contamination as well as other products intended for human consumption, and on the contamination of animals.

Namely

- ✓ technical/scientific support to the operating bodies during the development of the emergency also for the purpose of assessing the viability
- ✓ decontamination of sites and materials
- ✓ timely reporting of any irregularity or suspicious circumstance in relation to which the need to activate emergency provisions is assessed
- ✓ the competent service in cases where waste or environmental effects are present or expected

Rescue operations must be carried out with the appropriate precautions, to limit the spread of contamination among people and operators: unprotected interpersonal contacts must be avoided as much as possible.

In all cases where a rescuer has been accidentally exposed to contamination, he/she must be considered and treated as a victim.

USEFUL INFORMATION FOR THE POPULATION

In principle, the following advice and instructions are issued:

- ✓ identify a place far enough away or protected from the event to gather people waiting for assistance
- ✓ remove contaminated clothing
- ✓ avoid spreading the contamination to other people present, as far as possible
- ✓ if available near fountains or similar, wash contaminated parts thoroughly
- ✓ await the arrival of rescuers and leave your personal details (*it is very important for the safety of the person concerned and family members*)
- ✓ if symptoms appear later, request telephone information from the healthcare facilities, avoiding going personally to them without notice
- ✓ in case of uncontrolled removal from the area of the event, provide your personal details to the emergency health centre or to the numbers that will be given, following



the instructions that will be provided and avoiding contacts that may spread the contamination to other environments

- ✓ in case of suspected exposure to the contaminating agent, avoid eating, drinking and smoking

RESPONSE OF THE BASIC TEAM

Summary of tasks:

Initial analysis of the severity of the scenario and possible evolutions, in relation to substances, containers and environmental conditions; personal protection, quick assessment of impact and delimitation zones; assessment of needs, interview and information to the Operating Room (SMC/FLO)

The NBC emergency assigns, more and prior to other cases, an essential role to the Operating Room and requires the Team Leader to have a specific ability to assess "*before*" and "*at a safe distance*" the type and extent of the scenario, the necessary protections and the possibilities of relief. It requires the operator to be able to recognize and correctly use the appropriate PPE for the case.

In the gradual response mechanism, which provides for the use of units with different skills in relation to the severity of the scenario, the *Basic team (NBC)* has two levels of competence:

Level "0", characterized by

- ⇒ basic knowledge of chemical, bacteriological and radiological risk
- ⇒ knowledge of the criteria and conventions for the classification of substances
- ⇒ knowledge of the possibilities and techniques for the recognition of substances
- ⇒ knowledge of the criteria for delimiting areas
- ⇒ capacity to use the PPE and detection and decontamination equipment supplied to the team
- ⇒ ability to implement the basic procedures for intervention approach, zone isolation, anti-contamination and decontamination

Level "1", characterized by

- ⇒ ability to analyse the incident to assess the severity of the initial scenario and possible developments, in relation to substances, containers and environmental conditions
- ⇒ knowledge and ability to use safety data sheets regarding information on hazards and counter actions, also through contacts with producers/shippers



- ⇒ knowledge and use of criteria and techniques for the rapid assessment of potential damage and the delimitation of "hot", "warm" and "cold" areas
- ⇒ knowledge and use of defensive criteria and techniques for the containment of the event - where possible - and for the protection of the people present, of the environment and of the assets
- ⇒ ability to assess the suitability of the personal protective equipment available and deployment within the limits of effectiveness
- ⇒ ability to dialogue with the Operating Room and higher skills to report on the situation and agree on the appropriate strategy for the case, also in relation to prepared local emergency plans, the evolution of events and the effects of actions taken
- ⇒ ability to assess the feasibility of simple interventions autonomously and to coordinate their execution or to plan and implement an initial response, taking into account the skills and abilities of the available personnel, the personal protective and the control equipment
- ⇒ ability to evaluate the progress of the actions taken with reference to the expected response targets
- ⇒ ability to manage post-intervention functions

PROCEDURE MODEL - EIGHT STEPS

To set up the response procedures it is considered useful to adopt the eight-step model that is disseminated in literature, which provides for:

1. Site control and management
2. Identification of the material involved
3. Hazard and risk analysis
4. Assessment of protective clothing and equipment
5. Coordination of information and resources
6. Control, confinement and containment of the product
7. Decontamination
8. Closure of the intervention

The implementation of the reference procedure scheme is independent of the size and severity of the event.

In relation to the magnitude of the event, the eight steps can be implemented by the Basic team with the means provided (in a simple and small scenario), while in complex interventions with articulated or delicate scenarios it may be necessary to deploy more resources by level of competence and by number, however, the model remains the same.



Actions upon arrival on site (unconventional intervention)

When the attack has been recognized as such only upon arrival on site adequate protection actions must be taken.

Only if rescuers adopt all the necessary precautions and protective equipment are they able to safely manage the event. The careful assessment of risks and possible actions, to be implemented promptly, is essential to ensure the safety of rescuers.

It will then be necessary to alert the SMC/FLO so that they can alert the CBRN teams in order to handle the emergency as soon as possible.

Compared to an ordinary rescue operation, an attack will be full of unexpected events and operations must be well coordinated with police activities.

Criteria and measures for the intervention approach

- Determine the wind direction;
- Approach the scene while remaining upwind;
- Stop at an adequate distance to collect information;
- Notify other rescuers arriving;
- Adopt personal protective equipment complete with breathing apparatus from the initial reconnaissance;
- Pay attention to possible secondary devices;
- Bear in mind that this is a criminal scenario:
 - Prohibit unauthorized entry
 - Preserve any evidence
 - The attackers could be among the victims;
- Avoid contact with liquids;
- Assume and report to the SMC/FLO an overall view of the situation;
- Assess and promptly request every resource deemed necessary:
 - Law enforcement and related specialist teams (bomb disposal expert, ...)
 - Other Experts or Teams equipped for intervention or advice (chemical/biological, veterinary, electrical, etc.)

Tasks assigned to the Fire and Rescue Service (CBRN teams)

- Safety of all rescuers within the operational area;
- Classification and definition of zones;
- Rescue of victims in a contaminated area
- Technical rescue operations;
- Treatment of dangerous substances (identification, neutralization, recovery, ...);
- Water supply;
- Numbering and classification of firefighters;
- Decontamination and rehabilitation of operators;
- Connection with Police Forces and Authorities.



Actions to be taken

- Establish the area to be isolated according to the following criteria and definitions:
 - Zone A "hot" or "red": Extremely dangerous operating area, reserved exclusively for contact personnel with adequate protection (may include a totally inaccessible area inside, forbidden to anyone)
 - Zone B "warm" or "orange": potentially dangerous operating area, reserved for adequately protected fire and rescue service, medical and support personnel (area where decontamination corridor begins)
 - Zone C "cold" or "yellow": non-hazardous operating area, reserved for fire and rescue service, medical and support personnel (area where decontamination corridor ends, level 1 waiting area where victims are assigned to the assistance of medical personnel)
 - "External" or "white" zone: non-hazardous and non-operational area, not subject to control and restricted access to the public (it may be appropriate, in some cases, to identify a "green" area within this area for the Authorities, the media and the level 2 waiting area for reserve teams, family members, etc.);

Upon arrival of the CBRN team the following can also be done:

- Perform reconnaissance within the hot zone aimed at assessing the situation and the technical interventions necessary to stop or limit, as far as possible, the event or avoid greater risks;
- Identify and agree with the medical team managers the collection areas and methods of decontamination, if necessary, of triage and of treatment;
- Predict water needs, in particular for decontamination, preparing everything that is necessary;
- Identify and assist the living in the "hot" area according to the principles of priority provided by the health categorization (triage), that is the indications of the medical team managers; start of primary decontamination preparatory to medical assistance aimed at stabilizing vital functions and/or treatment by healthcare workers, possibly assisted by non-medical personnel;
- Plan and carry out the necessary technical interventions in the "hot" area;
- Collect appropriate samples to be analysis, better in agreement with experts (medical, environmental, scientific police, ...);
- Carry out, if necessary or agreed, primary collective decontamination;
- Take into account as far as possible the route and destination of the decontamination waste water;
- Take into account the conditions and the meteorological evolution.

Specific tasks of the NAMIRG OC

- Identify in general the scenario and the extent of the areas involved and the operational areas;
- Establish the Command post - in area C "cold" or "yellow" - upwind;
- Evaluate and inform rescuers on:
 - Specific risks present



- o PPE required for the different phases and areas of intervention
- o Planning of the intervention;
- Provide at the upper levels all useful information on:
 - o Type and size of the event
 - o Estimated number of victims
 - o Expected necessary resources
 - o Additional interventions that are considered necessary;
- Request the necessary reinforcements to be deployed;
- Arrange the census and the constant control of the firefighters present on the scene;
- Request that a contact person of the police forces be defined on the spot;
- Identify the operator to be in charge of decontamination;
- Identify the operator to be responsible for water resources;
- Assign specific tasks to check the safety of operations and PPE care;
- Coordinate the rescue operations with those of the Police;
- Take care of meteorological monitoring and therefore of the areas during the rescue operations;

The person in charge of rescue operations assesses the chances of saving lives and the risks for rescuers in relation to the time needed to guarantee them the highest level of protection, then defines the priorities and the development of operations to be carried out with the level of ongoing personal protection that is available.

DECONTAMINATION

The decontamination of victims to reduce the effect of agents penetrating through the skin within a few minutes from exposure to the agent and to reduce the effectiveness of agents on clothing and skin.

Moreover, decontamination also protects rescuers and other people from the risks of induced contamination.

Studies demonstrate the positive effect, in general, of the use of soap, detergents and bleach in the decontamination processes, when no specific inertizers exist or are available; however the substance most easily and immediately available for the first rescuers is **water**.

Where water is the only substance immediately available, the following assessment elements will be taken into account:

- the immediate removal of contaminated clothing is certainly positive since it reduces the amount and the contact time of the aggressive agent with the skin
- treatment with large quantities of cold water is normally useful, especially for water-soluble substances
- for oily or non-water-soluble substances, the decontamination effect improves with the use of warm water, sprinkling the affected material in advance with powdered substances that promote absorption (flours, sawdust, talc, activated carbon, etc.).

Criteria and measures for primary decontamination



- Prepare separate techniques and positions for primary collective decontamination and rescuer decontamination
- Coordinate decontamination processes with triage and medical assistance;
- Collect clothing and personal effects in bags or containers;
- Bear in mind the (*considerable*) water requirements for the operation and arrange provisions in relation to the decontaminating and spraying method;
- If possible contain waste water, activating the measurements and environmental protection measures as soon as the situation allows;
- Establish the priorities for decontamination with the medical managers

Decontamination of rescuers

For rescuers, primary decontamination (*called "technical" decontamination in international literature*) is used to remove the pollutant from the PPE used by the operators coming into direct contact with the substance ("*hot" zone or contact with the victims in the "warm" area*), to reduce the possibility of contamination when undressing.

This operation does not aim to restore the use of the PPE (which may in any case be destined for disposal), but only to protect the operator and to avoid spreading the contamination.

The area destined for this decontamination must be distinct, albeit accompanied, by that of primary decontamination of the victims.

Final decontamination of rescuers

The final or secondary decontamination is intended to remove any traces of contaminants from the operator's skin. In all cases of interventions that have involved contact with aggressive agents capable of spreading the contamination, secondary decontamination must be carried out on site using specific mobile units ("*Shelter" or field facilities*) equipped with hot showers, soap or other neutralizing substance. In the absence of adequate equipment, secondary decontamination will be carried out at the facilities set up by the medical service for other rescuers or victims.

Medical supervision will follow according to the cases. If secondary decontamination is not foreseen, when returning home the staff will perform a complete and energetic shower with warm water and soap, paying particular attention to the face, hands, nails and hair.

The operator will avoid eating, drinking, smoking, and performing physiological functions until decontamination has been completed.

PROCEDURES FOR DRESSING AND UNDRESSING

Type 1 - 2 - 3 protective suit (as per example)

DRESSING (done in the "cold" area **(C-yellow)**)



0. Required material: *accessory undergarments; breathing apparatus; suitable adhesive tape; accessory gloves; suit; heavy rubber boots; accessory helmet; radio communication equipment; anti-fogging;*
1. Dressing must take place with the help of at least one other operator;
2. Compatibly with the environmental conditions, remove as many personal effects (watches, wallets, etc.) as possible; in any case, the jacket and trousers of the suit and the boots;
3. Wear 2 *accessory undergarments*, one over the other (the hygienic and the protective one) to increase protection during the undressing operations. Do not wear the flash hood of the second undergarment yet, but close it only up to the level of the breastbone.
4. Wear the *self-contained breathing apparatus*, which must have a regulator already connected to it by means of its own strap; tighten the shoulder straps, but not excessively otherwise it will damage undergarments, and do not fasten the waist strap;
5. Put the mask of the self-contained breathing apparatus around the neck on the inside of the undergarment hood using the strap;
6. Wear the mask and tighten the straps around the head and face, checking the tightness to the face with the palm of the hand;
7. Open the cylinder keeping the regulator in standby position
8. Wear the flashhood of the undergarment and have the assistant attach the upper edge of the hood to the top part of the mask using *suitable adhesive tape* so that it does not drop over the visor;
9. Wear the *accessory gloves* and make the assistant seal the gloves to the sleeves of the undergarment using the adhesive tape, taking care to leave a fold of tape to allow easy removal and not to tighten it around the forearms excessively;
10. Complete the closure of the outer undergarment with the self-contained breathing apparatus, pulling the front closing up to the chin and seal the protective flap; at this point also close the waist strap of the SCBA at the waist;
11. Remove the tunic from its packaging and make sure that it is in sound condition first.
12. Put the trousers on with the help of the assistant starting from the bottom and first inserting the feet in the integrated protective shoe coverings, then pull the trousers up and fasten the clasp at the waist;
13. Insert the protective shoe coverings in the *heavy rubber boots* again with the help of the assistant, making sure that the boot covering strips have been raised beforehand;
14. Wear the *accessory helmet* and any other *radio communication equipment* (such as laryngophones, portable radios, etc.);
15. Have the assistant put the antifogging agent on the inside of the visor;
16. Have the regulator connected to the mask by the assistant and begin breathing to release it from a stand-by position, making sure that the air supply functions properly;
17. Have the assistant close the suit zipper all the way, without forcing, using the hands from the inside and making sure that the top of the suit sits correctly on the accessory helmet of the suit (or the intervention helmet) before closing so that the internal sight is effective;

18. With the suit closed at the front, insert the arms in the sleeves and straight into the two double pair of gloves (the internal and external integrated gloves);
19. Have the assistant check the correct alignment of the zipper flaps from the beginning to the end and the covering of the protective flap;
20. Perform normal movements with the arms and legs and bend the legs to see if there if the garment allows sufficient freedom and have the assistant give a last visual check;
21. Read the pressure gauge either by reading directly from the outside through the external visor (if the suit allows) or from the inside of the suit by removing the arm from the sleeve and taking a mental note the start-up pressure, then start the intervention.

UNDRESSING (in the area between Zone B and Zone C)

0. Required material: *waste disposal container; decontamination container;*
1. Removal of the suit can only take place after primary decontamination has been carried out and always with the help of at least one assistant, wearing at least a Type 3 suit equipped with an NBC filter mask, who will help the operator to undress by only the external parts of the equipment without absolutely touching him/her when exiting the garment!
2. With the help of the assistant, remove the boots, then have the boots disposed of in the waste disposal container;
3. Slide the hands out of the inner gloves of the suit and pull the arms out of the sleeves, raising them internally and push the top of the suit to tension the zipper so that the assistant can carefully open the zipper;
4. With the zipper completely open, have the assistant remove the external suit from the top downwards, taking care not to put the outer side of the suit in contact with the inside or, in any case, with you. The assistant will gradually roll the suit down until reaching the waist. The internal clasp will be unfastened and the suit will fall to the feet inside out;
5. Remove the feet from the boots but stay on the inside of the turned overalls.
6. Move sideways of a large step in a clean area so as not to put your feet where the boots were the boots and shoe coverings of the suit were standing and have the assistant dispose of the suit in the waste disposal container;
7. Remove the helmet and put it in the *decontamination container;*
8. Remove the tape from the hood of the undergarment and from the accessory gloves and put them into the decontamination container then open the hood of the undergarment;
9. Disconnect the regulator from the mask, then remove the SCBA, depressurize it and send it to the decontamination container;
10. Remove the outer accessory undergarment in the same manner as the suit by never putting the outside in contact with the inside of the undergarment or - worse - with yourself; gradually roll the undergarment from top to bottom until it falls inside out on the feet;

11. Remove the laces of the shoe coverings of the undergarment and remove the feet, trying to stay on the inside of the undergarment;
12. Move sideways and throw the undergarment in the decontamination container;
13. Remove the breathing mask and place it in the decontamination container;
14. Remove the gloves and place them in the decontamination container;
15. At the end of the undressing operation, the assistant will have to label the waste disposal container for subsequent delivery to the competent bodies, while the medical staff will have to collect and label the samples of mucus and saliva for testing.
16. At the end, go to the *secondary field decontamination station* or, in the absence of this, put on the clean clothes that you had before the operation.



ANNEXES

SOP CHECKLISTS

CHECKLIST OF NAMIRG SOP 1 - NAMIRG TEAM DEPLOYMENT

1. Actions in a mobilisation phase

- Alerting
 - The control room alerted by the MRCC/MRSC must:
 - alert the FLO, if required by the MRCC/MRSC
 - alert the operating rooms of other nations, which in turn will alert the NAMIRG operators on duty/off duty
 - alert the NAMIRG operators on duty
 - alert the NAMIRG operators off duty
 - Pula's control room will be connected to the Divulje air base, requesting the helicopter ETA at Pula airport.
 - All NAMIRG operators will go to Pula airport. The operators in Trieste will take the radios and lamps (ATEX). The Pula operators will start checking the NAMIRG material at Pula airport.
 - The Trieste control room will alert the Helicopter Unit in Venice
- Preliminary information
 - To ensure efficiency in NAMIRG operations, it is vital to have sufficient preliminary information on the incident and distress vessel. The key information about the distress vessel are:
 - its location
 - type of incident
 - where it occurred on the vessel
 - when it occurred
 - actions initiated on board the vessel and results obtained
 - condition of the vessel
 - The NAMIRG OC will gather all incident information so that risk assessments can be made and operations can be planned.
 - All operators will make sure that they have a valid ID document for expatriation.

2. Actions on arrival at the distress vessel

- Confirming vessel assessment



- Once the accident site is reached, the first authority on the distress vessel/in the incident area (e.g. MIRG OC or OSC) must confirm to the MRCC/MRSC whether the vessel assessment is appropriate.

3. Ongoing actions

- Monitoring identified threats
 - Identified threats must be actively monitored, and the key actors notified immediately of any changes in them.
- Mission abort
 - The NAMIRG team must always be ready to abort the mission and leave the ship, where the operating conditions would not enable the team to work safely.
 - The MRCC/MRSC must always ensure the presence of a means at the incident site to allow the NAMIRG team to be evacuated in an emergency.

CHECKLIST OF NAMIRG SOP 2 - OCCUPATIONAL SAFETY DURING A NAMIRG OPERATION

1. Occupational safety responsibilities

- The SMC is responsible for general occupational safety during the operation.
- The NAMIRG OC has overall responsibility for assessing the risks involved in carrying out the operations. However, each NAMIRG Group Leader holds primary responsibility for the occupational safety of his NAMIRG personnel.
- The master of the vessel always holds responsibility for the occupational safety of the distress vessel's crew.

2. Assessing the operational preconditions and appropriateness of the NAMIRG operations

- When approaching the location and while at the location, assess the following issues that affect occupational safety based on preliminary information and aerial reconnaissance:
 - Risks vs. achievable benefits.
 - Is it too dangerous to use winching or other means to board the distress vessel?
 - Have any of the following factors that would weaken occupational safety and/or threaten the success of the operation on board the distress vessel been realised?
 - General working conditions on board have weakened, primarily due to:
 - strong waves
 - extent of the fire
 - spread of smoke/circulation of smoke in the winching zone, etc.
 - There are no opportunities for retreat/departure (helicopter, another vessel, abandoning ship, etc.). One means of retreat/departure must always be available.
 - Serious listing = immediate danger of the vessel capsize. Visual observation or consult the vessel's crew. Rule of thumb: the vessel's technical systems should



work up to a tilt of 22 degrees, but moving aboard ship would then be very difficult or impossible.

- The firefighting water supply no longer works.
- The vessel's pumping systems no longer work.
- A complete blackout in which backup lighting does not work.
- The vessel is sinking or clearly about to sink and pumping will not help.
- Any other direct threat to personnel.
- Terrorism or the threat of terrorism (+1 theory).
- When your resources are insufficient to complete the mission and no more are on their way (personnel, equipment).

- Based on your observations, make the final decision on whether to start or cancel the operation. Consider what can be achieved with the current resources.

3. Emergency situation - halting the mission due to sudden changes in safety circumstances

- Notify the master of the vessel and MRCC/MRSC that the mission is being halted and request the emergency evacuation of the team/teams.
- Move to the most protected location (from smoke) from which to abandon ship or be fetched by helicopter, if a helicopter is able to do so.
- If a helicopter cannot pick up the team/teams, seriously consider abandoning the distress vessel if the risks in the list above are being realised. Notify the SMC that the ship is being abandoned and test contact with the MRCC/MRSC using emergency channel 16 on the Maritime VHF radio.
- Abandoning ship:
 - Put on rescue suits
 - Muster the entire team at the assembly station
 - Check the personal rescue equipment (PLB)
 - Leave the ship using the safest available method, on the safest side, in the manner instructed in NAMIRG training:
 - Activating PLBs:
 - A: A communication device should be the primary method of contact with searchers. PLBs should only be used as a last resort.
 - B: In good conditions, the team should remain grouped in the water. Only the OC or GL should activate his/her own device. If the team is lost and has, for some reason, become separated (in difficult weather conditions, darkness, etc.), each member of the team should activate their own PLB.
 - Take watertight communication devices (Maritime VHF)
 - Take lighting and signalling devices
 - If possible, put energy bars/drink bottles in pockets
 - Descend or jump into the water from a safe place
 - Swim far away from the vessel (if the vessel sinks, there will be strong vortexes/suction, and the danger of being sucked in).

- Make sure you have a knife to hand.
- Form a floating chain
- Keep the chain moving slightly to ward off the cold
- Wait for the helicopter/surface vessel
- Signal your presence

CHECKLIST OF NAMIRG SOP 3 - NAMIRG FIRE LIAISON OFFICER (FLO)

1. Actions in the mobilisation phase

- Reports on participation in the operation to a sufficient extent.
 - MRCC/MRSC
 - NAMIRG OC
 - FRSs
- Transfers to the MRCC/MRSC.

2. Actions on arrival at the MRCC/MRSC

- Goes through the preliminary information with the MRCC/MRSC
 - Precise location of the incident
 - When it occurred
 - Name and type of vessel in distress
 - Number of people involved
 - Number to be rescued
 - Hazmat Danger
 - Units alerted
 - NAMIRG teams:
 - Strength and capabilities (resources)
 - Contact information
 - ETA at boarding point
 - ETA at distress vessel
 - Others
 - Weather conditions at the scene of the accident
- Ascertains how and from where the distress vessel will be reached:
 - Helicopter
 - Boat (own, Coast Guard, other)
- Ascertains which radio channels are to be used
- Forwards the confirmed and updated information to the NAMIRG teams.

3. Ongoing actions

- Continue to obtain further information
- Acts as a link between the NAMIRG Operation Commander and MRCC/MRSC
- Forwards the situation information, requests, instructions, etc. issued by the NAMIRG OC to the extent necessary.
- Supports the NAMIRG OC in ensuring uninterrupted operations.



- Keeps a log of:
 - Resources on the vessel
 - Resources on route
 - Additional resources requested
- Assesses the availability of additional resources with a focus on achieving results (Which? From where? How? When?).
- Keeps a log of all key events and when they occur
 - For his own operations (FLO)
 - For NAMIRG operations
 - Time of alert
 - Time of departure
 - Number of people per team, including names
 - Time of arrival at vessel
 - Information about what is occurring at the target
 - Mission progress
 - Key orders and decisions
- Keeps in contact
 - NAMIRG OC
 - NAMIRG teams that have not as yet arrived at the distress vessel
 - Participating FRSs
- Checks that the DV is aware of the approaching team and what is required from them aboard the vessel, such as assisting the NAMIRG OC on the bridge.

4. Completion of operation

- Does any reporting associated with the mission
 - Draws up a mission report with the MIRC OC
 - Mission analysis and debriefing

CHECKLIST OF MIRC SOP 4 - NAMIRG OPERATIONS COMMANDER (NAMIRG OC)

1. Actions in a mobilisation phase

- Reports on receipt of the alert
- Goes through the preliminary information with the MRCC/MRSC (FLO, if available)
 - Precise location of the incident
 - When it occurred
 - Name and type of vessel in distress
 - Number of people involved
 - Number to be rescued
 - Hazmat Danger
 - Units alerted
 - NAMIRG team info
 - Strength and capabilities
 - Contact information



- ETA at boarding point
- ETA at the distress vessel
- Others
- Weather conditions at the accident site
- Ascertains how communications will be carried out
- Ascertains how and from where the distress vessel will be reached
-
- Helicopter
- Boat (own, Coast Guard, other)
- Identifies the risks
- Mobilises the team
- Notifies to the FLO and/or MRCC/MRSC team departure.

2. Actions on arrival at the distress vessel

- Identifies the risks (from helicopter)
- Tests communications links with MRCC/MRSC
 - (FRS) radio, Maritime VHF, GSM, SATPHONE (if present)
 - Notification of arrival on distress vessel
- Establishes
 - Boarding point
 - Evacuation/rest/fire station point
 - No exposure to danger
 - Clear exits from the vessel
 - Usually close to a winching point and in a protected area of the top deck
 - Command point (the bridge of DV, if possible)
- Contacts the master of the vessel, and ascertains that the preliminary information is correct:
 - That NAMIRG assistance is required
 - The actual situation and all risks
 - Any measures that have been carried out and the results achieved
 - What assistance is desired
 - Any resources the vessel can offer
 - The vessel's technical situation
- With the master of the vessel
 - Agrees a tactical/operational plan and decisions required to stabilise and contain the incident on board the distress vessel.
- Gives operational indications to the NAMIRG Group Leader
- Communicates to the GL the position of evacuation point
- Contacts the MRCC/MRSC, and
 - Communicates the situation and confirm their safety level assessment and relevant threat factors.
 - Communicates the position of boarding, evacuation and command points.
 - Determine resource requirements (for uninterrupted operations)

- Prepare to receive incoming teams and establish a NAMIRG command team (if that is the case).

3. Ongoing actions

- Ensure occupational safety
 - The vessel's safety status
 - Ongoing risk assessment
- Appoints GL to monitor smoke diving
- Conducts a risk assessment of any rescue dives
- Evaluate the sufficiency of resources
 - Compressed air
 - Reserve crews
 - Food/Drink
- Ensure uninterrupted operations
 - Evaluate the sufficiency of resources and the possible need for additional resources.
 - Inform the MRCC/MRSC (FLO) of resources needed
- With the master of the vessel
 - Evaluates the vessel firefighting systems, and the potential to utilise other firefighting techniques
 - Watertight doors
 - Smoke ventilation
 - Monitors the vessel's stability
- Keep a log of all key events and when they occur
- Keep in contact, at intervals of not more than 20 minutes, with
 - NAMIRG teams
 - MRCC/MRSC
 - FLO
- Utilises the vessel's crew
 - Expertise
 - Local knowledge

4. Completion of operation

- Provides a situation report to the distress vessel master, MRCC/MRSC and the party to which the responsibility for the incident will be transferred (if that is the case).
 - The measures that have been performed
 - The results achieved
 - The current situation
 - Any damage
 - Recommendations on further actions.
- Together with the MRCC/MRSC ensures that the decision to conclude NAMIRG operations and the reasons for that are recorded and entered in the MRCC/MRSC situation log.
 - Reasons for transferring responsibility or aborting the operation

- To whom responsibility will be transferred
- When responsibility will be or has been transferred
- Matters agreed regarding communications and related responsibilities
- Ensures to have the information necessary to draft a final report on the operation.
 - Information on the vessel, etc.
 - Measures performed and their results
 - Contact information for the contact persons
- Initiates preparations for the return trip.
 - Agrees on transport arrangements with the MRCC/MRSC
 - Attends to assembling personnel and equipment
- Ensures that equipment and tools provided by the vessel are returned (e.g. radios, Fire/Safety Plans, etc.)
- Ensures that everyone leaves the DV safely once the mission is completed

CHECKLIST OF MIRG SOP 5 - NAMIRG GROUP LEADER (NAMIRG GL)

1. Actions in a mobilisation phase

- Reports on receipt of the alert
- Goes through the preliminary information with the NAMIRG OC, or the FLO:
 - Precise location of the incident
 - Name and type of vessel in distress
 - Condition of the vessel (electricity, firefighting systems, operability)
 - Number of people involved
 - Number to be rescued
 - Hazmat Danger
 - Units alerted
 - NAMIRG team info
 - Strength and capabilities
 - Contact information
 - ETA at boarding point
 - ETA at distress vessel
 - Others
 - Weather conditions at the accident site
- Ascertains how communications will be carried out
- Ascertain how and from where the distress vessel will be reached
 - Helicopter
 - Boat (own, Coast Guard, other)
- Identifies the risks
- Test communications
 - VHF marine radios
 - FRS radios
 - Spare batteries
- Notifies the Fire Liaison Officer of team departure



1. Actions on arrival at the distress vessel

- Contacts the on-scene NAMIRG OC.
 - Determines:
 - The actual situation
 - Any measures that have been carried out and the results achieved
 - The team's task
 - Any resources the vessel can offer
 - The vessel's technical situation
 - Communications (FRS radios, direct channel, vessel's own communication devices)
 - Procedures
 - Evacuation/rest/fire station point
- Draws up an action plan
 - Utilises the vessel's Fire/Safety Plan
- Equips crews in pairs

2. Ongoing actions

- Ensure occupational safety
 - The vessel's safety status
 - Ongoing risk assessment
- Monitors smoke diving
 - Conducts a risk assessment of any rescue dives
 - Evaluate the sufficiency of resources
 - Compressed air
 - Reserve crews
 - Food/Drink
- Evaluate the sufficiency of resources and the possible need for additional resources.
- Keep in contact with the NAMIRG OC, at intervals of not more than 20 minutes
- Utilises the vessel's crew
 - Expertise
 - Local knowledge

3. Completion of operation

- Ensures that everyone leaves the distress vessel safely once the mission is completed
- Organises post-mission maintenance/activities

CHECKLIST OF MIRG SOP 6 - NAMIRG CREW MEMBER (FIREFIGHTER)

1. Actions in a mobilisation phase

- Goes through the preliminary information with the NAMIRG OC/GL
- Gathers and packs personal basic equipment in accordance with the separate checklist
- Everything that is brought along should be weighed (crew + gear = team weight).
 - Notify the NAMIRG OC of the actual weights
- Familiarises himself with communications



- Undertakes personal care (for example, toilet visit) before entering the helicopter
- Transfers to DV
- If necessary, uses the flight-time to rehydrate/re-energise

2. Actions on arrival at the distress vessel

- Takes note of the conditions on the vessel's deck.
- Conducts a controlled transfer of equipment, transfers it to safety and, if necessary, mooring it to the landing site. In demanding conditions, considers potential solutions with the NAMIRG OC/GL whilst still in air.
- Establishes an evacuation/rest/fire station point in a place where both crew and equipment is protected, following NAMIRG GL instructions.

3. Ongoing actions

- Obeys the NAMIRG GL's instructions in order to perform the mission safely and effectively

4. Completion of operation

- Returns to the vessel's crew all the equipment and tools provided by the vessel (e.g. radios, Fire/Safety Plans, etc.)

CHECKLIST NAMIRG SOP 7 - COMMUNICATION

1. Actions in a mobilisation phase

- Take the requisite communication devices on the mission
 - FRS radio
 - Maritime VHF
 - GSM
 - SATPHONE (if possible)
- Test the systems
- Ask for radio work channel

2. Actions on arrival at the distress vessel

When the NAMIRG team is on board the DV, communications between the NAMIRG OC and the MRCC/MRSC (SMC/FLO) will take place primarily with marine VHF radios, using established channels and communicated to all participants in the rescue operations, from MRCC/MRSC.

Marine VHF radios will also be used to communicate with the OSC, if activated, and with other rescue operators in the area of operations.

The communications between NAMIRG OC and GL and the other firefighters will take place with the fire and rescue service radio. The NAMIRG GL and at least one firefighter for each team (of 2 operators) involved in the operations, will be equipped with a marine VHF radio, to be used for listening, in case communications concerning the safety of operations or of the ship are transmitted.



If communications on board the distress vessel are prevented for structural or other reasons, the crew should reserve communications equipment for the NAMIRG teams insofar as this is possible.

In case of need, for communications between the OC and the GL, the fixed communication systems of the ship (intercoms, loudspeakers, etc.) can be used.

If communications on board the distress vessel are prevented for structural or other reasons, the crew should reserve communications equipment for the NAMIRG teams insofar as this is possible.

In case of need, for communications between the OC and the GL, the fixed communication systems of the ship (intercoms, loudspeakers, etc.) can be used.

3. Ongoing actions

- Keep in contact, at intervals of not more than 20 minutes, MRCC/MRSC and FLO with NAMIRG CO and NAMIRG CO with NAMIRG GL.

CHECKLIST NAMIRG SOP 8 - OPERATION WITH HELICOPTER

1. Actions in a mobilisation phase

- The pilot of the helicopter leads all operations.
- All those participating in maritime search and rescue tasks must wear a rescue suit throughout the helicopter flight (MANUAL lifejacket, PLB, EBS).
- By default, communications devices should be switched off during the flight. NAMIRG CO and the pilot of an aircraft can agree otherwise if necessary.
- Any team equipment must be packed in the appropriate lockers.
 - When packing these lockers, the lids must be closed and securely latched.
- The helicopter's crew is responsible for packing the helicopter's equipment.
- The NAMIRG OC or GL should be aware of the total weight of the team and its equipment. All gear, persons, and personal equipment must be weighed before take-off, and the pilot of the aircraft must be notified of the combined weight to an accuracy of 5 kg, preferably as soon as the information is available, but at the latest on arrival at the aircraft.
- A helicopter's load capacity varies according to weather conditions and the planned route.
- The helicopter's crew determine where rescue personnel will sit in the helicopter.
- Seatbelts must be worn at all times.
- The NAMIRG OC is always the last to board the helicopter (first out).
- Ask the helicopter's crew whether headsets are available for listening to radio traffic.
- Team members must obey all orders given by the helicopter crew.
- It is worth keeping a plastic bag or similar handy in case of nausea. (Remember anti-emetics!)

2. Actions on arrival at the distress vessel



- The pilot of the helicopter is responsible for both the transfer and the safety of the operation, and he will decide on whether any personnel will be winched to the target.
- The helicopter crew's surface rescuer is always the first person to be winched to the target (if he/she is present), then NAMIRG OC, then the rest of the team.
- No one must touch the winch cable before it has touched either the vessel's deck or the ground. (Take note when reaching for the cable).
- The NAMIRG OC is the last to board the helicopter when leaving the target.
- If a NAMIRG OC asks to be winched (to the vessel), he/she should note that the distress vessel must perform certain actions before the helicopter can approach it:
 - All those involved in the operation must use clearly distinguishable protective clothing or vests, and helmets.
 - Anyone who is not taking part in the operation should move away from the winching zone, and all unnecessary equipment should be moved out of the way
 - Any rotating antenna, rigging or the suchlike near the winching zone should be appropriately secured.
 - Firefighting equipment must be kept ready for use (firefighting team).
 - The person meeting the helicopter must be ready to give hand signals to the pilot.
 - The standby boat must be ready for use, likewise lifesaving equipment.
 - When lighting the winching zone in the dark, the lights must not blind the helicopter pilot.

CHECKLIST NAMIRG SOP 9 - OPERATION FROM A VESSEL

1. Actions in a mobilisation phase

- Consider the safety of the MIRC team when operating out of a boat
 - Standard flight equipment (Remember PLB), AUTOMATIC life jacket
 - Helmet
 - Movement on deck
- Pack equipment in sturdy boxes
- Secure equipment to prevent it from moving
- It is worth keeping a plastic bag or similar handy in case of nausea. (Remember anti-emetics!)

2. Actions on arrival at the distress vessel

- The master of the vessel is responsible for both the transfer and the safety of the operation, and he will decide on whether any personnel will be transferred to the target.
- Note that a small boat next to a larger ship will not move in sync with the larger vessel.
- In certain conditions the ship-to-ship transfer could be impossible
- Transfer to the DV mainly occurs through the pilot hatch/boarding station
- Pay attention to the following when transferring to the DV:
 - One person at a time, without personal equipment bags or other equipment
 - Protective gear must be used at all times



- Equipment should primarily be transferred to the vessel using cranes and other aids, in small and light units.

If the vessel is to be boarded using a pilot ladder, the first NAMIRG person across should climb the ladder and arrange a safety rope to secure all other members of the team, that should always attach their harnesses to the safety rope as they climb up to the deck.

CHECKLIST NAMIRG SOP 10 – VESSEL FIRE

- Obtain information about the target area from the Safety/Fire Plan:
 - water supply
 - water extraction
 - access routes
 - smoke extraction
 - dangerous substances
 - watertight doors, etc.
- Define the best possible attack route to the target.
- If possible, attempt to approach the target from below.
- If possible, turn off ventilation systems, so that the fire/smoke does not spread.
- Larger vessels will have automatic fire doors between sections.
- Ship fires are usually extinguished by limiting oxygen, that is, by 'sealing' areas with, for example, watertight doors.
- Ensure that there is enough hose (working allowance) for a two-person smoke diving team and a two-person safety team.
- Test radio contact before commencing smoke diving.
- Once the operation has started, maintain continual radio contact between the smoke diving team and the smoke zone, so that, if necessary, messages can be relayed between the smoke divers and the smoke diving supervisors (NAMIRG GL). There must be continual contact between the smoke diving supervisor and the NAMIRG OC.
- Use a safety leash when working in smoke-filled areas.
- Make certain that there is a safety diver team and smoke diving supervision.
- The safety team can check upper areas or other areas during smoke diving, but the safety team must be able to respond within one minute
- If there is only one NAMIRG team at the target, the following things should be noted:
 - The safety team must be rested (a pair that has just returned from smoke diving cannot immediately act as a safety team).
 - Ensure that smoke diving teams can rest for the required period.
- Use snaplights to show routes that have already been taken (when possible)
- Mark searched cabins with Triage pen by drawing a cross above the door handle.
- Pre-empt the fire spreading to upper areas